



# Environmental Technology Verification Report

## Field Portable Gas Chromatograph/Mass Spectrometer

Viking Instruments Corporation  
SpectraTrak™ 672



Environmental Technology  
Verification Program





# Environmental Technology Verification Report

Field Portable Gas Chromatograph/ Mass  
Spectrometer

Viking Instruments Corporation  
SpectraTrak™ 672

Prepared By

Wayne Einfeld  
Susan F. Bender  
Michael R. Keenan  
Steven M. Thornberg  
Michael M. Hightower

Environmental Characterization  
and Monitoring Department  
Sandia National Laboratories  
Albuquerque, New Mexico

Sponsored by

U.S. ENVIRONMENTAL PROTECTION AGENCY  
OFFICE OF RESEARCH AND DEVELOPMENT  
NATIONAL EXPOSURE RESEARCH LABORATORY  
ENVIRONMENTAL SCIENCES DIVISION  
LAS VEGAS, NEVADA

## Notice

The information in this document has been funded wholly or in part by the U.S. Environmental Protection Agency (EPA) under an Interagency Agreement number DW89936700-01-0 with the U.S. Department of Energy's Sandia National Laboratory. This verification effort was supported by the Consortium for Site Characterization Technology, a pilot operating under the EPA's Environmental Technology Verification (ETV) Program. It has been subjected to the Agency's peer and administrative review, and it has been approved for publication as an EPA document. Mention of corporation names, trade names, or commercial products does not constitute endorsement or recommendation for use of specific products.

In 1995, the U. S. Environmental Protection Agency established the Environmental Technology Verification Program. The purpose of the Program is to promote the acceptance and use of innovative environmental technologies. The verification of the performance of the Viking Instruments Corporation SpectraTrak™ 672 field transportable gas chromatograph/mass spectrometer (GC/MS) system represents one of the first attempts at employing a testing process for the purpose of performance verification. One goal of this process is to generate accurate and credible data that can be used to verify the characteristics of the technologies participating in the program. This report presents the results of our first application of the testing process. We learned a great deal about the testing process and have applied what we learned to improve upon it. We expect that each demonstration will serve to improve the next and that this project merely represents the first step in a complex process to make future demonstrations more efficient, less costly, and more useful.



**UNITED STATES ENVIRONMENTAL PROTECTION AGENCY**

Office of Research and Development  
Washington, D.C. 20460



**ENVIRONMENTAL TECHNOLOGY VERIFICATION PROGRAM  
VERIFICATION STATEMENT**

**TECHNOLOGY TYPE:** FIELD PORTABLE GAS CHROMATOGRAPH/MASS SPECTROMETER

**APPLICATION:** MEASUREMENT OF VOLATILE ORGANICS IN SOIL, WATER, AND SOIL GAS

**TECHNOLOGY NAME:** SpectraTrak™ 672

**COMPANY:** VIKING INSTRUMENTS CORPORATION  
**ADDRESS:** 3800 CONCORDE PARKWAY, SUITE 1500  
CHANTILLY, VIRGINIA 20151

**PHONE:** (703) 968-0101

The U.S. Environmental Protection Agency (EPA) has created a program to facilitate the deployment of innovative environmental technologies through performance verification and information dissemination. The goal of the Environmental Technology Verification (ETV) Program is to further environmental protection by substantially accelerating the acceptance and use of improved and more cost effective technologies. The ETV is intended to assist and inform those involved in the design, distribution, permitting, and purchase of environmental technologies. This verification statement provides a summary of the demonstration and results for the Viking SpectraTrak™ 672 field portable gas chromatograph/mass spectrometer (GC/MS) system.

**PROGRAM OPERATION**

The EPA, in partnership with recognized testing organizations, objectively and systematically evaluates the performance of innovative technologies. Together, with the full participation of the technology developer, they develop plans, conduct tests, collect and analyze data, and report findings. The evaluations are conducted according to a rigorous demonstration plan and established protocols for quality assurance. The EPA's National Exposure Research Laboratory, which conducts demonstrations of site characterization and monitoring technologies, selected Sandia National Laboratories, Albuquerque, New Mexico as the testing organization for field portable GC/MS systems.

**DEMONSTRATION DESCRIPTION**

In July and September 1995, the performance of two field transportable GC/MS systems was determined under field conditions. Each system was independently evaluated by comparing field analysis results to those obtained using approved reference methods. Performance evaluation (PE), spiked, and environmental samples were used to independently assess the accuracy, precision, and comparability of each instrument.

The demonstration was designed to detect and measure a series of primary target analytes in soil gas, water, and soil. The primary target analytes at the U.S. Department of Energy's Savannah River Site, near Aiken, South Carolina, were trichloroethene and tetrachloroethene. The primary analytes at Wurtsmith Air Force Base, in Oscoda, Michigan, were

benzene, toluene, and xylenes. Secondary analytes at the Michigan site included a variety of chlorinated organic solvents. The sites were chosen because they exhibit a wide range of concentrations for most of the analytes and provided different climatic and geological conditions. The conditions at each of these sites represent typical, but not all inclusive, conditions under which the technology would be expected to operate. Details of the demonstration, including a data summary and discussion of results may be found in the report entitled "Environmental Technology Verification Report, Field Portable Gas Chromatograph/Mass Spectrometer, Viking Instruments Corporation SpectraTrak™ 672." The EPA document number for this report is EPA/600/R-97/148.

## TECHNOLOGY DESCRIPTION

GC/MS is a proven laboratory analytical technology that has been used in environmental laboratories for many years. The combination of gas chromatography and mass spectrometry enables the rapid separation and identification of individual compounds in complex mixtures. The gas chromatograph separates the sample extract into individual components. The mass spectrometer then ionizes each component which provides the energy to fragment molecules into characteristic ions. These ion fragments are then separated by mass and detected as charged particles, which constitutes a mass spectrum. Quantitation is achieved by comparing the abundance of those ions which are characteristic of a specific compound to the response received from the mass spectrum obtained from a reference standard. This spectrum can be used in the identification and quantitation of each component in the sample extract. For nontarget or unknown analytes the mass spectrum is compared to a computerized library of compounds to provide identification of the unknown. Field transportable GC/MS is a versatile technique that can be used to provide rapid screening data or laboratory quality confirmatory analyses. In most systems, the instrument configuration can also be quickly changed to accommodate different inlets for media such as soil, soil gas, and water. As with all field analytical studies, it may be necessary to send a portion of the samples to an independent laboratory for confirmatory analyses.

The Viking SpectraTrak™ 672 is a commercially available GC/MS system that provides laboratory-grade performance in a field transportable package. The instrument, including the on-board computer, is ruggedized and encapsulated in a shock-mounted transport case. It weighs about 145 lbs. and can be transported and operated in a small van. The instrument used in the demonstration used a purge and trap device for water and soil analysis and direct injection for soil gas samples. The minimum detection limit is 5 ppb for soil gas, 5 µg/kg for soil, and 5µg/L for water. The instrument requires a skilled operator. Recommended training is one week for a chemist with GC/MS experience. At the time of the demonstration, the baseline cost of the SpectraTrak™ 672 was \$145,000.

## VERIFICATION OF PERFORMANCE

The observed performance characteristics of the SpectraTrak™ 672 include the following:

- **Throughput:** Sample throughput was approximately 30 minutes for soil extracts and water samples using purge and trap. The direct injection soil gas samples required 15 minutes each for analysis.
- **Completeness:** The SpectraTrak™ 672 detected 99 percent of the target compounds reported by the reference laboratory.
- **Precision:** Precision was calculated from the analysis of a series of duplicate samples from each media. The results are reported in terms of relative percent difference (RPD). The values compiled from both sites generally fell within the range of 0 to 30 percent RPD for soil and 0 to 15 percent RPD for the water and soil gas samples.

- **Accuracy:** Accuracy was evaluated by comparing the Viking GC/MS analysis results with performance evaluation and spiked samples of known contaminant concentrations. Absolute percent accuracy values from both sites were calculated for five target analytes. For soil, most of the values fall in the 0 to 20 percent range with a median of 13 percent. For water, most of the values fall in the 0 to 20 percent range with a median of 14 percent. The soil gas accuracy data generally fall in the 0 to 60 percent range with a median of 28 percent.
- **Comparability:** The SpectraTrak™ 672 produced water and soil data that were comparable to the reference laboratory data (median absolute percent difference was less than 50 percent). The soil gas data were not comparable. This was due in part to difficulties experienced by the reference laboratory in analyzing soil gas samples and other problems associated with sample handling and transport.
- **Deployment:** The system was ready to analyze samples within 30 minutes of arrival at the site. At the Savannah River Site the instrument was transported in and operated from a hatchback passenger car; a van was used at the Wurtsmith Air Force Base site.

The results of the demonstration show that the Viking SpectraTrak™ 672 field portable gas chromatograph/mass spectrometer can provide useful, cost-effective data for environmental problem-solving and decision making. The deviation between the Viking GC/MS and reference laboratory results for the soil gas samples, while statistically significant, is not so great as to preclude the effective use of the Viking GC/MS system in many field screening applications. We were unable to determine whether the Viking soil gas data or that of the reference laboratory or both were problematic. Undoubtedly, this instrument will be employed in a variety of applications, ranging from serving as a complement to data generated in a fixed analytical laboratory to generating data that will stand alone in the decision-making process. As with any technology selection, the user must determine what is appropriate for the application and the project data quality objectives.

Gary J. Foley, Ph.D.  
Director  
National Exposure Research Laboratory  
Office of Research and Development

**NOTICE:** EPA verifications are based on an evaluation of technology performance under specific, predetermined criteria and the appropriate quality assurance procedures. EPA makes no expressed or implied warranties as to the performance of the technology and does not certify that a technology will always, under circumstances other than those tested, operate at the levels verified. The end user is solely responsible for complying with any and all applicable Federal, State and Local requirements.

## Foreword

The U.S. Environmental Protection Agency (EPA) is charged by Congress with protecting the nation's natural resources. The National Exposure Research Laboratory (NERL) is EPA's center for the investigation of technical and management approaches for identifying and quantifying risks to human health and the environment. NERL's research goals are to (1) develop and evaluate technologies for the characterization and monitoring of air, soil, and water; (2) support regulatory and policy decisions; and (3) provide the science support needed to ensure effective implementation of environmental regulations and strategies.

EPA created the Environmental Technology Verification (ETV) Program to facilitate the deployment of innovative technologies through performance verification and information dissemination. The goal of the ETV Program is to further environmental protection by substantially accelerating the acceptance and use of improved and cost-effective technologies. The ETV Program is intended to assist and inform those involved in the design, distribution, permitting, and purchase of environmental technologies.

EPA's Superfund Innovative Technology Evaluation (SITE) Program evaluates technologies for the characterization and remediation of Superfund and Resource Conservation and Recovery Act corrective action sites. The SITE Program was created to provide reliable cost and performance data to speed the acceptance of innovative remediation, characterization, and monitoring technologies. One component of SITE, the Monitoring and Measurement Technologies Program, evaluates new and innovative measurement and monitoring technologies. Effective measurement and monitoring technologies are needed to (1) assess the degree of contamination at a site, (2) provide data to determine the risk to public health or the environment, (3) be cost effective, and (4) monitor the success or failure of a remediation process. This program is administered by NERL's Environmental Sciences Division in Las Vegas, Nevada.

Candidate technologies for these programs originate from the private sector and must be market ready. Through the ETV and SITE Programs, developers are given the opportunity to conduct rigorous demonstrations of their technologies under realistic field conditions. By completing the evaluation and distributing the results, EPA establishes a baseline for acceptance and use of these technologies.

Gary J. Foley, Ph.D.  
Director  
National Exposure Research Laboratory  
Office of Research and Development



## Acknowledgments

The authors wish to acknowledge the support of all those who helped plan and conduct the demonstrations, analyze the data, and prepare this report. In particular we recognize the technical expertise of Susan Bender, Jeanne Barrera, Dr. Steve Thornberg, Dr. Mike Keenan, Grace Bujewski, Gary Brown, Bob Helgesen, Dr. Curt Mowry, and Dr. Brian Rutherford of Sandia National Laboratories. The contributions of Gary Robertson, Dr. Stephen Billets, and Eric Koglin of the EPA's National Exposure Research Laboratory, Environmental Sciences Division in Las Vegas, Nevada, are also recognized in the various aspects of this project.

Demonstration preparation and performance also required the assistance of numerous personnel from the Savannah River Technology Center and University of Michigan/Wurtsmith Air Force Base. The contributions of Joe Rossabi and co-workers at the Savannah River Technology Center and Mike Barcelona and co-workers at the University of Michigan are gratefully acknowledged. The Wurtsmith site is a national test site funded by the Strategic Environmental Research and Development Program. Cooperation and assistance from this agency is also acknowledged.

Performance evaluation (PE) samples provided a common reference for the field technologies. Individuals and reference laboratories who analyzed water and soil samples included Alan Hewitt, of the U.S. Army Cold Regions Research and Engineering Laboratory, for soil PE samples; and Michael Wilson, of the U.S. EPA Office of Emergency and Remedial Response, Analytical Operations and Data Quality Center, for the water PE samples.

We also acknowledge the participation of Viking Instruments Corporation, in particular, Ms. Lisa White, Applications Chemist, who operated the instrument during the demonstrations.

For more information on the Viking GC/MS demonstrations, contact:

Gary Robertson, Project Technical Leader  
Environmental Protection Agency  
National Exposure Research Laboratory  
Human Exposure and Atmospheric Sciences Division  
P.O. Box 93478  
Las Vegas, Nevada 89193-3478  
(702) 798-2215

For more information on the Viking GC/MS technology, contact:

Jeffrey Christenson, Director of Marketing  
Viking Instruments Corporation  
3800 Concorde Parkway, Suite 1500  
Chantilly, Virginia 20151  
(703) 968-0101  
(703)968-0166

# Contents

Notice .....	ii
Foreword .....	vi
Acknowledgments .....	vii
Figures .....	xiii
Tables .....	xiv
Abbreviations and Acronyms .....	xv

## Sections

1. Executive Summary .....	1
Technology Description .....	2
Demonstration Objectives and Approach .....	2
Demonstration Results .....	2
Performance Evaluation .....	3
2. Introduction .....	4
Site Characterization Technology Challenge .....	4
Technology Verification Process .....	4
Needs Identification and Technology Selection .....	5
Demonstration Planning and Implementation .....	5
Report Preparation .....	5
Information Distribution .....	6
The GC/MS Demonstration .....	6
3. Technology Description .....	9
Theory of Operation and Background Information .....	9
Operational Characteristics .....	9
Performance Factors .....	12
Detection Limits .....	12
Dynamic Range .....	12
Sample Throughput .....	12

Technology Advantages .....	13
Technology Limitations .....	13
Training Required .....	13
Sample Matrix Effects .....	14
Spectral Interferences .....	14
4. Site Descriptions and Demonstration Design .....	15
Technology Demonstration Objectives .....	15
Qualitative Assessments .....	15
Quantitative Assessments .....	15
Site Selection and Description .....	16
Savannah River Site Description .....	16
Wurtsmith Air Force Base Description .....	18
Overview of the Field Demonstrations .....	21
Overview of Sample Collection, Handling, and Distribution .....	22
SRS Sample Collection .....	22
WAFB Sample Collection .....	25
Reference Laboratory Selection and Analysis Methodology .....	26
General Engineering Laboratory .....	27
Traverse Analytical and Pace Environmental Laboratories .....	27
SRS and WAFB On-Site Laboratories .....	27
Pre-demonstration Sampling and Analysis .....	28
Deviations from the Demonstration Plan .....	28
Pre-demonstration Activities .....	28
SRS Soil Spike Samples .....	28
SRS Soil Gas Survey Evaluation .....	28
Soil Gas Samples at WAFB .....	29
Water Samples at WAFB .....	29
Calibration Check Sample Analysis .....	29
5. Reference Laboratory Analysis Results and Evaluation .....	30
Laboratory Operations .....	30
General Engineering Laboratories .....	30
SRS On-Site Laboratory .....	30
Traverse Analytical Laboratory .....	30

Pace Environmental Laboratories .....	31
WAFB On-Site Laboratory .....	31
Laboratory Compound Detection Limits .....	31
Laboratory Data Quality Assessment Methods .....	31
Precision Analysis .....	32
Accuracy Analysis .....	32
Laboratory Internal Quality Control Metrics .....	33
Laboratory Data Quality Levels .....	34
Laboratory Data Validation for the SRS Demonstration .....	34
GEL Data Quality Evaluation .....	34
GEL Data Quality Summary .....	36
SRS On-Site Laboratory Data Quality Evaluation .....	36
SRS Laboratory Data Quality Summary .....	37
Laboratory Data Validation for the WAFB Demonstration .....	37
Traverse Data Quality Evaluation .....	38
Traverse Laboratory Data Quality Summary .....	40
Pace Data Quality Evaluation .....	40
Pace Data Quality Summary .....	42
Summary Description of Laboratory Data Quality .....	42
6. Technology Demonstration Results and Evaluation .....	44
Introduction .....	44
Pre-Demonstration Developer Claims .....	44
Field Demonstration Data Evaluation Approach .....	45
Instrument Precision Evaluation .....	45
Instrument Accuracy Evaluation .....	46
Instrument Comparison with Reference Laboratory Data .....	47
Summary of Instrument Performance Goals .....	50
Accuracy .....	50
Precision .....	51
Viking to Reference Laboratory Comparison .....	52
Field Operation Observations .....	53
Viking Accuracy and Precision Results .....	54
Viking Accuracy -- SRS Demonstration .....	54
Viking Accuracy -- WAFB Demonstration .....	55
Overall Viking Accuracy Performance .....	56
Viking Precision -- SRS Demonstration .....	57

Viking Precision -- WAFB Demonstration .....	58
Overall Viking Precision Performance .....	59
Viking to Reference Laboratory Data Comparison .....	60
Scatter Plots/Histograms -- SRS Demonstration .....	60
Scatter Plots/Histograms -- WAFB Demonstration .....	60
Overall Viking to Laboratory Comparison Results .....	67
Summary of Viking Accuracy, Precision, and Laboratory Comparison Performance .....	68
Other Viking GC/MS Performance Indicators .....	69
Unknown Compound Identification in Complex Mixtures .....	69
Field Handling and Operation .....	69
Overall Viking GC/MS Performance Conclusions .....	70
7. Applications Assessment .....	72
Applicability to Field Operations .....	72
Capital and Field Operation Costs .....	72
Discussion of the Technology .....	72
Rapid Analysis .....	72
Sampling and Sample Cost Advantages .....	73
Performance Advantages .....	73
Transportability .....	74
Field Screening of Samples .....	74
Interferences .....	74
Conclusions .....	74
8. Developer's Forum .....	75
General Comments .....	75
New Viking Transportable GC/MS System .....	76
9. Previous Deployments .....	79
10. References .....	80

## Appendix

A: Analytical Method for the Operation of the SpectraTrak™ 672 .....	A-1
--	-----

## Figures

2-1	Example total ion chromatogram of a complex mixture	7
3-1	Drawing of Viking SpectraTrak™ 672 GC/MS	10
3-2	Drawing of the weather-proof, shock-protected transport case for the Viking SpectraTrak™ 672	10
4-1	Location of the Savannah River Site	17
4-2	SRS M-Area Well Locations	19
4-3	Location of Wurtsmith Air Force Base	20
4-4	WAFB Fire Training Area 2 Sampling Locations	21
6-1	Example scatter plots with simulated data	49
6-2	Example histograms with simulated data	51
6-3	Plot of daily temperatures during the SRS demonstration	54
6-4	Plot of daily temperatures during the WAFB demonstration	54
6-5	Absolute percent accuracy histogram for Viking soil samples	56
6-6	Absolute percent accuracy histogram for Viking water samples	56
6-7	Absolute percent accuracy histogram for Viking soil gas samples	57
6-8	Relative percent difference histogram for Viking soil samples	59
6-9	Relative percent difference histogram for Viking water samples	59
6-10	Relative percent difference histogram for Viking soil gas samples	60
6-11	Viking vs. Laboratory data for SRS low concentration water samples	62
6-12	Viking vs. Laboratory data for SRS high concentration water samples	62
6-13	Percent difference histogram for SRS water samples	63
6-14	Viking vs. Laboratory data for SRS soil gas samples	63
6-15	Percent difference histogram for SRS soil gas samples	63
6-16	Viking vs. Laboratory data for WAFB soil samples	63
6-17	Relative percent difference histogram for WAFB soil samples	64
6-18	Viking vs. Laboratory data for WAFB low concentration water samples	65
6-19	Viking vs. Laboratory data for WAFB high concentration water samples	65
6-20	Relative percent difference histogram for WAFB water samples	66
6-21	Viking vs. Laboratory data for WAFB soil gas samples	66
6-22	Relative percent difference histogram for WAFB soil gas samples	66
6-23	Absolute percent difference histogram for soil samples	67
6-24	Absolute percent difference histogram for water samples	67
6-25	Absolute percent difference histogram for gas samples	68
6-26	Viking GC/MS total ion chromatogram from a WAFB water sample	70
8-1	A breakaway view of the Viking SpectraTrak™ 572 Portable GC/MS	78

## Tables

3-1	Viking SpectraTrak™ 672 Instrument Specifications	11
3-2	Detection Limits for the Viking SpectraTrak™ 672 GC/MS	12
4-1	PCE and TCE Concentrations in SRS M-Area Wells	18
4-2	Historical Ground Water Contamination Levels at WAFB	19
4-3	VOC Concentrations in WAFB Fire Training Area 2 Wells	21
4-4	Sample Terminology and Description	23
4-5	SRS Demonstration Sample Type and Count	24
4-6	WAFB Demonstration Sample Type and Count	25
5-1	Reference Laboratory Practical Quantitation Limits	31
5-2	GEL Laboratory Accuracy Data	35
5-3	GEL Laboratory Precision Data	36
5-4	SRS Laboratory Accuracy Data	37
5-5	SRS Laboratory Precision Data	37
5-6	Traverse Laboratory Accuracy Data	38
5-7	WAFB Water and Soil PE/Spike Sample Reference Concentrations	39
5-8	Traverse Laboratory Precision Data	39
5-9	WAFB Water and Soil Duplicate Sample Concentrations	39
5-10	Pace Laboratory Accuracy Data	41
5-11	WAFB Soil Gas PE/Spike Sample Reference Concentrations	41
5-12	Pace Laboratory Precision Data	42
5-13	WAFB Soil Gas Duplicate Sample Concentrations	42
5-14	SRS Demonstration Laboratory Data Quality Ranking	42
5-15	WAFB Demonstration Laboratory Data Quality Ranking	43
6-1	Viking GC/MS Recoveries at SRS	55
6-2	Viking Recoveries at Wurtsmith	55
6-3	Viking and Reference Laboratory Accuracy Summary	57
6-4	Viking Precision for SRS Demonstration	58
6-5	Viking Precision for Wurtsmith Demonstration	58
6-6	Viking and Reference Laboratory Precision Summary	60
6-7	Viking-Laboratory Comparison Summary	68
6-8	Summary Performance of the Viking GC/MS	69
6-9	Tentatively Identified Compounds from a Wurtsmith Water Sample Analysis	70
6-10	Summary of Viking Performance Goals and Actual Performance	71
7-1	Viking SpectraTrak™ 672 GC/MS Capital and Field Operation Costs	74



## Abbreviations and Acronyms

AC	Alternating current
amu	Atomic mass unit
amp	Ampere
APA	Absolute percent accuracy
APD	Absolute percent difference
BTEX	Benzene, toluene, ethylbenzene, xylenes
CSCT	Consortium for Site Characterization Technology
DNAPL	Dense nonaqueous phase liquid
DCE	Dichloroethylene
DIF	Percent difference
DoD	Department of Defense
DOE	Department of Energy
DOT	Department of Transportation
EPA	Environmental Protection Agency
ESD-LV	Environmental Sciences Division
ETV	Environmental Technology Verification Program
ETVR	Environmental Technology Verification Report
g	Gram
GC/MS	Gas chromatograph/mass spectrometer
GEL	General Engineering Laboratories
Hz	Hertz
kg	Kilogram
kW	Kilowatt
L	Liter
$\mu\text{g}$	Microgram
mg	Milligram
mL	Milliliter
MS	Mass spectrometer
NCIBRD	National Center for Integrated Bioremediation Research and Development
NA	Not analyzed
ND	Not detected or no determination
NERL	National Exposure Research Laboratory
NETTS	National Environmental Technology Test Sites Program
ng	nanogram
NP	Not present
PAH	Polycyclic aromatic hydrocarbons
PCE	Tetrachloroethene
PE	Performance evaluation
ppb	Parts per billion
ppm	Parts per million
ppt	Parts per trillion
PQL	Practical quantitation limit
QA	Quality assurance
QC	Quality control
REC	Percent recovery
RPD	Relative percent difference

RSD	Relative standard deviation
SERDP	Strategic Environmental Research and Development Program
SIM	Single ion monitoring
SNL	Sandia National Laboratories
SRS	Savannah River Site
SUMMA®	(Registered trademark for Passivated Canister Sampling Apparatus)
TCA	Trichloroethane
TCE	Trichloroethene
v	Volts
VOA	Volatile organic analysis
VOC	Volatile organic compound
WAFB	Wurtsmith Air Force Base
W	Watt

## **Section 1**

### **Executive Summary**

The performance evaluation of innovative and alternative environmental technologies is an integral part of the U.S. Environmental Protection Agency's (EPA) mission. Early efforts focused on evaluating technologies that supported the implementation of the Clean Air and Clean Water Acts. In 1987 the Agency began to demonstrate and evaluate the cost and performance of remediation and monitoring technologies under the Superfund Innovative Technology Evaluation (SITE) program (in response to the mandate in the Superfund Amendments and Reauthorization Act of 1987). In 1990, the U.S. Technology Policy was announced. This policy placed a renewed emphasis on "...making the best use of technology in achieving the national goals of improved quality of life for all Americans, continued economic growth, and national security." In the spirit of the technology policy, the Agency began to direct a portion of its resources toward the promotion, recognition, acceptance, and use of U.S.-developed innovative environmental technologies both domestically and abroad.

The Environmental Technology Verification (ETV) Program was created by the Agency to facilitate the deployment of innovative technologies through performance verification and information dissemination. The goal of the ETV Program is to further environmental protection by substantially accelerating the acceptance and use of improved and cost-effective technologies. The ETV Program is intended to assist and inform those involved in the design, distribution, permitting, purchase and use of environmental technologies. The ETV Program capitalizes upon and applies the lessons that were learned in the implementation of the SITE Program to the verification of twelve categories of environmental technology: Drinking Water Systems, Pollution Prevention/Waste Treatment, Pollution Prevention/ Innovative Coatings and Coatings Equipment, Indoor Air Products, Advanced Monitoring Systems, EvTEC (an independent, private-sector approach), Wet Weather Flows Technologies, Pollution Prevention/Metal Finishing, Source Water Protection Technologies, Site Characterization and Monitoring Technology (a.k.a. Consortium for Site Characterization Technology (CSCT)), and Climate Change Technologies. The performance verification contained in this report is based on the data collected during a demonstration of a field portable gas chromatograph/mass spectrometer (GC/MS) system. The demonstration was administered by the Consortium for Site Characterization Technology.

For each pilot, EPA utilizes the expertise of partner "verification organizations" to design efficient procedures for conducting performance tests of environmental technologies. EPA selects its partners from both the public and private sectors including Federal laboratories, states, and private sector entities. Verification organizations oversee and report verification activities based on testing and quality assurance protocols developed with input from all major stakeholder/customer groups associated with the technology area. The U.S. Department of Energy's Sandia National Laboratories, Albuquerque, New Mexico, served as the verification organization for this demonstration.

In 1995, the Consortium conducted a demonstration of two field transportable gas chromatograph/mass spectrometer systems. These technologies can be used for rapid field analysis of organic-contaminated soil, ground water, and soil gas. They are designed to hasten and simplify the process of site characterization and to provide timely, on-site information that contributes to better decision making by site managers. The two system developers participating in this demonstration were Bruker-Franzen Analytical Systems, Inc.<sup>1</sup> and Viking Instruments Corporation. The purpose of this Environmental Technology Verification Report (ETVR) is to document demonstration activities, present demonstration data, and verify the performance of

---

<sup>1</sup> The company is now known as Bruker Instruments, Inc.

the Viking Instruments Corporation SpectraTrak™ 672 field-transportable GC/MS. Demonstration results from the other system are presented in a separate report.

### ***Technology Description***

The Viking SpectraTrak™ 672 GC/MS is an integrated system combining a temperature programmable gas chromatograph combined with a Hewlett Packard quadrupole mass spectrometer. This self-contained, field transportable system, whose design has been adapted from laboratory technology, uses a chromatographic column and accompanying mass spectrometer to provide separation, identification, and quantification of volatile and semi-volatile organic compounds in sample matrices that include soil, liquid, and gas. The column enables the separation of individual analytes in complex mixtures. A mass spectrum, produced for each compound in the sample, can be used for compound identification and quantification. An integrated computer and data acquisition system enables identification and quantification of the analytes by comparison of detector response with a calibration table constructed from standards of known concentration. The system provides detection limits that range from about 5 ppm for direct gas injection to as low as 5 ppb for many volatile and semi-volatile organic contaminants in soils and liquids.

### ***Demonstration Objectives and Approach***

The GC/MS systems were taken to two geologically and climatologically different sites: the U. S. Department of Energy's Savannah River Site (SRS), near Aiken, South Carolina, and Wurtsmith Air Force Base (WAFB), in Oscoda, Michigan. The demonstration at the Savannah River Site was conducted in July 1995 and the Wurtsmith AFB demonstration in September 1995. Both sites contained soil, ground water, and soil gas that were contaminated with a variety of volatile organic compounds. The demonstrations were designed to evaluate the capabilities of each field transportable system.

The primary objectives of this demonstration were: (1) to evaluate instrument performance; (2) to determine how well each field instrument performed compared to reference laboratory data; (3) to evaluate instrument performance on different sample media; (4) to evaluate adverse environmental effects on instrument performance; and, (5) to determine logistical needs and field analysis costs.

### ***Demonstration Results***

The demonstration provided adequate analytical and operational data with which to evaluate the performance of the Viking SpectraTrak™ 672 GC/MS system. Accuracy was evaluated by comparing the Viking GC/MS analysis results with performance evaluation and spiked samples of known contaminant concentrations. Absolute percent accuracy values from both sites were calculated for five target analytes. For soil, most of the values fall in the 0 to 20 percent range with a median of 13 percent. For water, most of the values fall in the 0 to 20 percent range with a median of 14 percent. The soil gas accuracy data generally fall in the 0 to 60 percent range with a median of 28 percent. Precision was calculated from the analysis of a series of duplicate samples from each media. The results are reported in terms of relative percent difference (RPD). The values compiled from both sites generally fell within the range of 0 to 30 percent RPD for soil and 0 to 15 percent RPD for the water and soil gas samples. The SpectraTrak™ 672 produced water and soil data that were comparable to the reference laboratory data (median absolute percent difference was less than 50 percent). However, the soil gas data were not comparable. This was due in part to difficulties experienced by the reference laboratory in analyzing soil gas samples and other problems associated with sample handling and transport.

Considerable variability was encountered in the results from reference laboratories, illustrating the degree of difficulty associated with collection, handling, shipment, storage, and analysis of soil gas, water, and soil samples using off-site laboratories. This demonstration revealed that use of field analytical methods with instruments such as the Viking system can eliminate some of these sample handling problems.

### ***Performance Evaluation***

Overall, the results of the demonstration indicated that most of the performance goals for the Viking GC/MS system were met under field conditions, and that the system can reliably provide good quality, near-real-time field analysis of soil, water, and soil gas samples contaminated by organic compounds. The system was easily transported in an automobile and required only one technician for operation. A limited analysis of capital and field operational costs for the Viking system shows that field use of the system may provide some cost savings when compared to fixed-laboratory analyses. Based on the results of this demonstration, the Viking SpectraTrak™ 672 instrument was determined to be a mature field instrument, capable of providing on-site analyses of soil and water samples comparable to those from a fixed laboratory.

## **Section 2 Introduction**

### ***Site Characterization Technology Challenge***

Rapid, reliable, and cost-effective field screening and analysis technologies are needed to assist in the complex task of characterizing and monitoring hazardous and chemical waste sites. Environmental regulators and site managers are often reluctant to use new technologies which have not been validated in an objective EPA-sanctioned testing program or similar process which facilitates acceptance. Until field characterization technology performance can be verified through objective evaluations, users will remain skeptical of innovative technologies, despite their promise of better, less expensive, and faster environmental analyses.

The Environmental Technology Verification (ETV) Program was created by the U. S. Environmental Protection Agency (EPA) to facilitate the deployment of innovative technologies through performance verification and information dissemination. The goal of the ETV Program is to further environmental protection by substantially accelerating the acceptance and use of improved and cost-effective technologies. The ETV Program is intended to assist and inform those involved in the design, distribution, permitting, purchase, and use of environmental technologies. The ETV Program capitalizes upon and applies the lessons that were learned in the implementation of the SITE Program to the verification of twelve categories of environmental technology: Drinking Water Systems, Pollution Prevention/Waste Treatment, Pollution Prevention/Innovative Coatings and Coatings Equipment, Indoor Air Products, Advanced Monitoring Systems, EvTEC (an independent, private-sector approach), Wet Weather Flows Technologies, Pollution Prevention/Metal Finishing, Source Water Protection Technologies, Site Characterization and Monitoring Technology (a.k.a. Consortium for Site Characterization Technology (CSCT)), and Climate Change Technologies. The performance verification contained in this report was based on the data collected during a demonstration of field transportable gas chromatograph/mass spectrometer (GC/MS) systems. The demonstration was administered by the Consortium for Site Characterization Technology. The mission of the Consortium is to identify, demonstrate, and verify the performance of innovative site characterization and monitoring technologies. The Consortium also disseminates information about technology performance to developers, environmental remediation site managers, consulting engineers, and regulators.

For each pilot, EPA utilizes the expertise of partner "verification organizations" to design efficient procedures for conducting performance tests of environmental technologies. EPA selects its partners from both the public and private sectors including Federal laboratories, states, and private sector entities. Verification organizations oversee and report verification activities based on testing and quality assurance protocols developed with input from all major stakeholder/customer groups associated with the technology area. The U.S. Department of Energy's Sandia National Laboratories, Albuquerque, New Mexico, served as the verification organization for this demonstration.

### ***Technology Verification Process***

The technology verification process is intended to serve as a template for conducting technology demonstrations that will generate high-quality data which EPA can use to verify technology performance. Four key steps are inherent in the process:

- Needs Identification and Technology Selection;
- Demonstration Planning and Implementation;
- Report Preparation; and,
- Information Distribution.

Each component is discussed in detail in the following paragraphs.

### **Needs Identification and Technology Selection**

The first aspect of the technology verification process is to determine technology needs of the EPA and the regulated community. EPA, the U.S. Department of Energy, the U.S. Department of Defense, industry, and state agencies are asked to identify technology needs and interest in a technology. Once a technology need is established, a search is conducted to identify suitable technologies that will address the need. The technology search and identification process consists of reviewing responses to *Commerce Business Daily* announcements, searches of industry and trade publications, attendance at related conferences, and leads from technology developers. Characterization and monitoring technologies are evaluated against the following criteria:

- Meets user needs.
- May be used in the field or in a mobile laboratory.
- Applicable to a variety of environmentally impacted sites.
- High potential for resolving problems for which current methods are unsatisfactory.
- Costs are competitive with current methods.
- Performance is better than current methods in areas such as data quality, sample preparation, or analytical turnaround time.
- Uses techniques that are easier and safer than current methods.
- Is a commercially available, field-ready technology.

### **Demonstration Planning and Implementation**

After a technology has been selected, EPA, the verification organization, and the developer agree to responsibilities for conducting the demonstration and evaluating the technology. The following issues are addressed at this time:

- Identifying demonstration sites that will provide the appropriate physical or chemical attributes, in the desired environmental media;
- Identifying and defining the roles of demonstration participants, observers, and reviewers;
- Determining logistical and support requirements (for example, field equipment, power and water sources, mobile laboratory, communications network);
- Arranging analytical and sampling support; and,
- Preparing and implementing a demonstration plan that addresses the experimental design, sampling design, quality assurance/quality control (QA/QC), health and safety considerations, scheduling of field and laboratory operations, data analysis procedures, and reporting requirements.

### **Report Preparation**

Innovative technologies are evaluated independently and, when possible, against conventional technologies. The field technologies are operated by the developers in the presence of independent technology observers. The technology observers are provided by EPA or a third party group. Demonstration data are used to evaluate the capabilities, limitations, and field applications of each technology. Following the demonstration, all raw and reduced data used to evaluate each technology are

compiled into a technology evaluation report, which is mandated by EPA as a record of the demonstration. A data summary and detailed evaluation of each technology are published in an ETVR.

### **Information Distribution**

The goal of the information distribution strategy is to ensure that ETVRs are readily available to interested parties through traditional data distribution pathways, such as printed documents. Documents are also available on the World Wide Web through the ETV Web site (<http://www.epa.gov/etv>) and through a Web site supported by the EPA Office of Solid Waste and Emergency Response's Technology Innovation Office (<http://clu-in.com>).

### ***The GC/MS Demonstration***

In late 1994, the process of technology selection for GC/MS systems was initiated by publishing a notice to conduct a technology demonstration in the *Commerce Business Daily*. In addition, active solicitation of potential participants was conducted using manufacturer and technical literature references. Final technology selection was made by the Consortium based on the readiness of technologies for field demonstration and their applicability to the measurement of volatile organic contaminants at environmentally impacted sites.

GC/MS is a proven laboratory analytical technology that has been in use in environmental laboratories for many years. The instruments are highly versatile with many different types of analyses easily performed on the same system. Because of issues such as cost and complexity, the technology has not been fully adopted for use by the field analytical community. The purpose of this demonstration was to provide not only an evaluation of field portable GC/MS technology results compared to fixed laboratory analyses, but also to evaluate the transportability, ruggedness, ease of operation, and versatility of the field instruments.

For this demonstration, three instrument systems were initially selected for verification. Two of the systems selected were field portable GC/MS systems, one from Viking Instruments Corporation and the other from Bruker-Franzen Analytical Systems, Inc. The other technology identified was a portable direct sampling device for an ion trap mass spectrometer system manufactured by Teledyne Electronic Technologies. However, since the direct sampling inlet for this MS system was not commercially available, its performance has not been verified. In the summer of 1995, the Consortium conducted the demonstration which was coordinated by Sandia National Laboratories.

The versatility of field GC/MS instruments is one of their primary features. For example, an instrument may be used in a rapid screening mode to analyze a large number of samples to estimate analyte concentrations. This same instrument may be used the next day to provide fixed-laboratory-quality data on selected samples with accompanying quality control data. The GC/MS can also identify other contaminants that may be present that may have been missed in previous surveys. Conventional screening instruments, such as portable gas chromatographs, would only indicate that an unknown substance is present.

An example of compound selectivity for a GC/MS is shown in Figure 2-1. The upper portion of the figure is a GC/MS total ion chromatogram from a water sample containing numerous volatile organic compounds. The total ion chromatogram is a plot of total mass detector response as a function of time from sample injection into the instrument. Many peaks can be noted in the retention time window between 7 and 11 minutes. In many cases the peaks are not completely resolved as evidenced by the absence of a clear baseline. The inset figure shows a reconstructed ion chromatogram for ion mass 146. This corresponds to the molecular ion peak of the three isomers of dichlorobenzene. The relative intensities of these peaks are at a level of about 60,000 with the background considerably higher at an intensity level between 500,000 and 1,000,000. This is an example of the ability of the GC/MS to detect and quantitate compounds in the midst of high background levels of other volatile organic compounds.



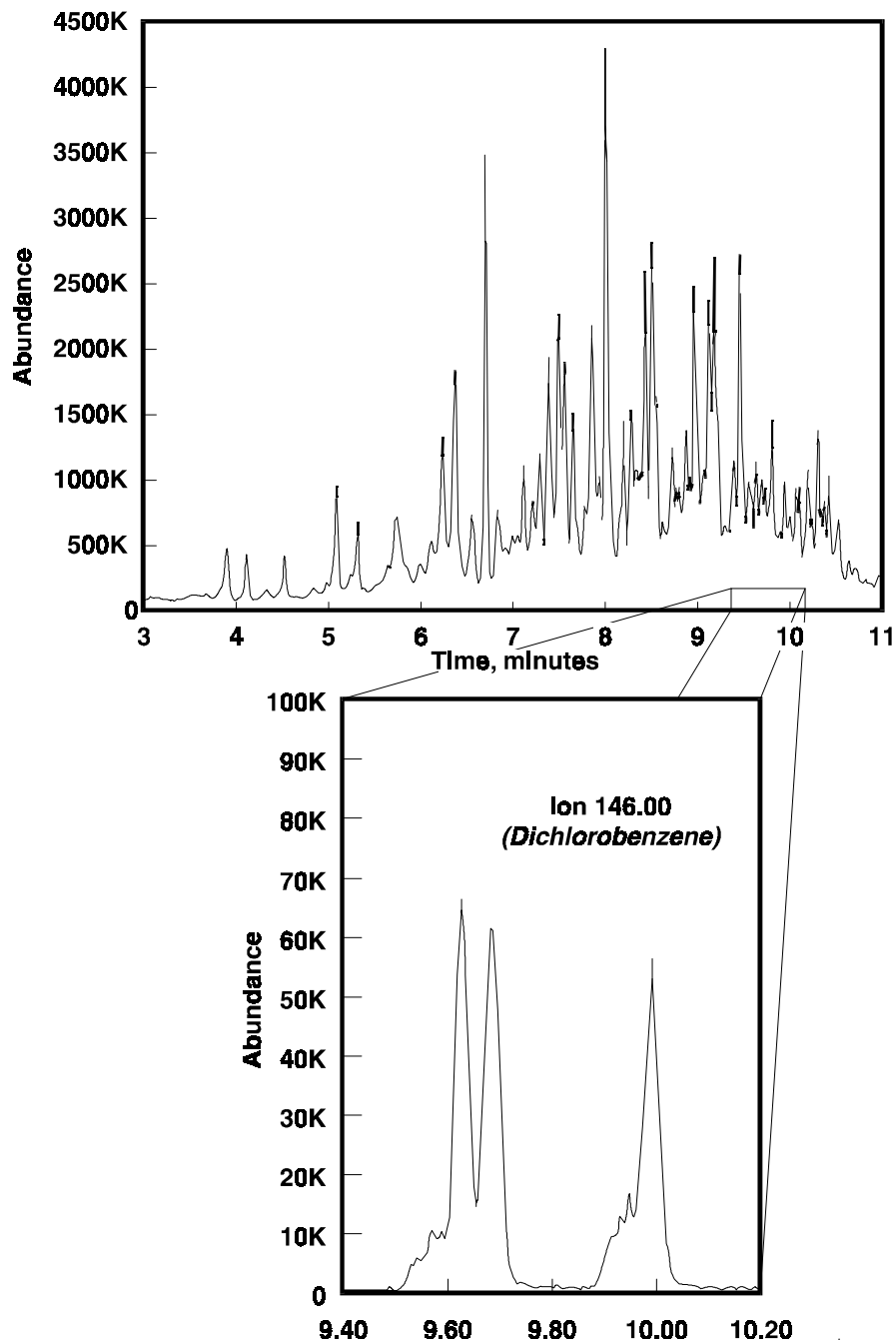

**Figure 2-1.** Example total ion chromatogram of a complex mixture. The inset shows the ability of the GC/MS system to detect the presence of dichlorobenzenes in a high organic background.

The objectives of this technology demonstration were essentially five-fold:

- To evaluate instrument performance;
- To determine how well each field instrument performed compared to reference laboratory data;
- To evaluate developer goals regarding instrument performance on different sample media;
- To evaluate adverse environmental effects on instrument performance; and,
- To determine the logistical and economic resources needed to operate each instrument.

## Section 3 Technology Description

### *Theory of Operation and Background Information*

Gas chromatography/mass spectrometry (GC/MS) is a proven laboratory technology that has been in use in fixed analytical laboratories for many years. The instruments are highly versatile, with many different types of analyses easily performed on the same instrument. The combination of gas chromatography and mass spectrometry enables rapid separation and identification of individual compounds in complex mixtures. One of the features of the GC/MS is its ability to detect and quantitate the compounds of interest in the presence of large backgrounds of interfering substances. Using GC/MS, an experienced analyst can often identify every compound in a complex mixture.

The varying degrees of affinity of compounds in a mixture to the GC column coating makes their separation possible. The greater the molecular affinity, the slower the molecule moves through the column. Less affinity on the other hand causes the molecule to elute from the column more rapidly. A portion of the GC column effluent is directed to the MS ion source where the molecules are fragmented into charged species. These charged species are in turn passed through a quadrupole filter which separates them on the basis of their charge-to-mass ratio. The charged fragments are finally sensed at an electron multiplier at the opposite end of the quadrupole filter. The array of fragments detected for each eluting compound is known as a mass spectrum and provides the basis for compound identification and quantitation. The GC/MS mass spectrum can be used to determine the molecular weight and molecular formula of an unknown compound. In addition, characteristic fragmentation patterns produced by sample ionization can be used to deduce molecular structure. Typical detection limits of about  $10^{-12}$ g can be realized with MS.

### *Operational Characteristics*<sup>2</sup>

The SpectraTrak™ 672 is a complete GC/MS system that provides laboratory-grade performance in a transportable package (Figure 3-1). The system is equipped with a temperature-programmable mini-GC and a Hewlett Packard 5972A quadrupole MS. Scan rates up to 1,800 atomic mass units (amu) per second are possible over a mass range of 1.6 to 700 amu with unit-mass resolution. General instrument specifications are presented in Table 3-1. A diagram of the instrument in a weather-proof, shock-mounted case is shown in Figure 3-2.

Sample introduction techniques include the following:

- Split/splitless injection.
- Ambient air sampling, concentration, and thermal desorption.
- Purge-and-trap on-line sampling of volatile organic compounds in water or soils using either a compact single-sample sparger or commercially available autosamplers.
- Direct MS, using a membrane inlet, which allows for very rapid screening of target compounds or simple unknowns.

---

<sup>2</sup> The information presented in the remainder of Section 3 was provided by Viking. It has been minimally edited. The information is solely that of Viking and should not be construed to reflect the views or opinions of the EPA.

## Viking SpectraTrak™ 672 Transportable GC/MS System

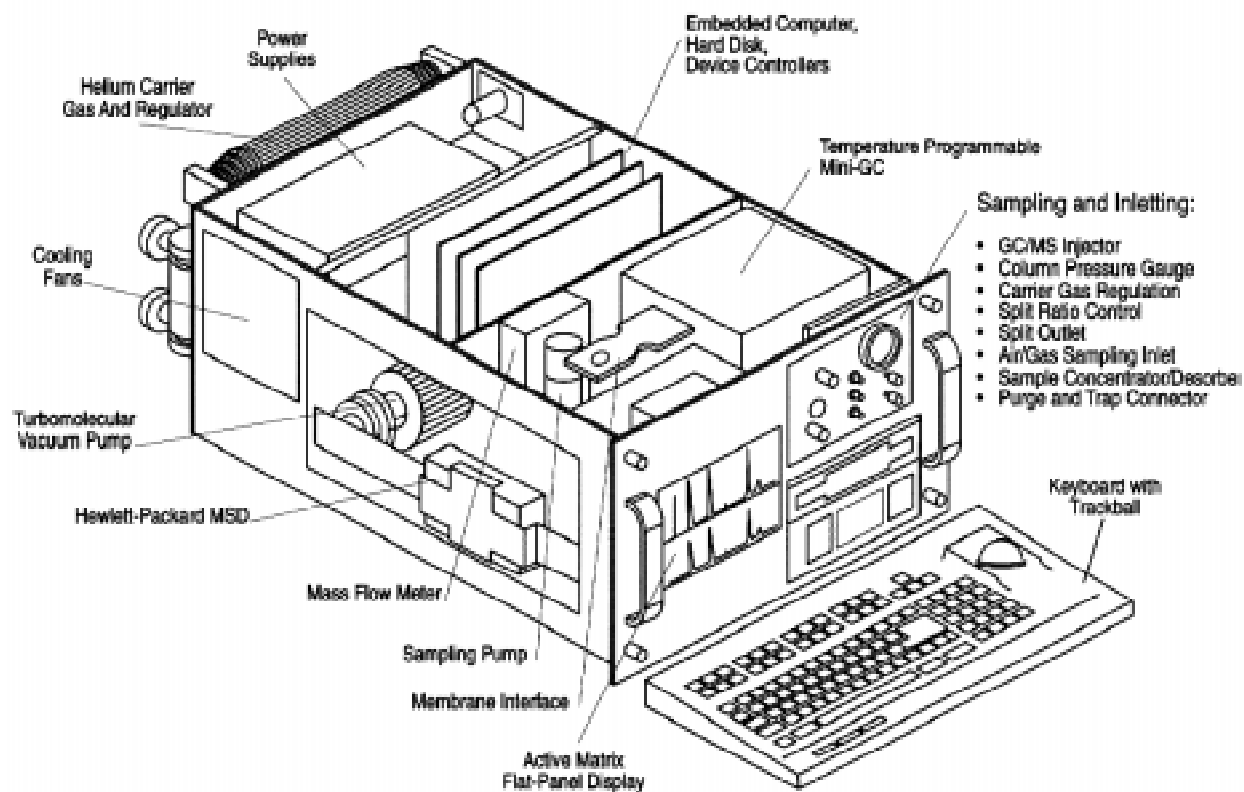

Figure 3-1. Drawing of Viking SpectraTrak™ 672 GC/MS. (Courtesy of Viking Instruments)

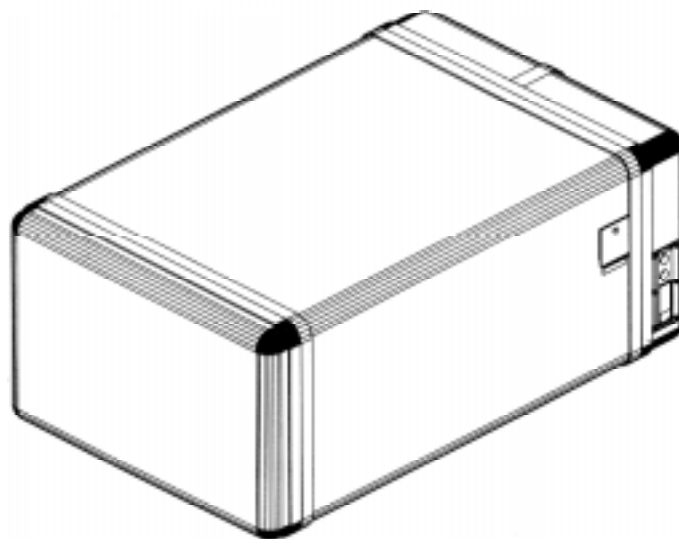

Figure 3-2. Drawing of the weather-proof, shock-protected transport case for the Viking SpectraTrak™ 672. (Courtesy of Viking Instruments)

The technology is designed to provide separation, identification, and quantification of volatile and semivolatile organic compounds in solids, liquids, or gases. The GC separates a complex combination of analytes and isolates individual analytes based on vapor pressures and chemical affinities for the stationary phase of the chromatographic column. As the individual analytes exit the column, the MS detects the analytes and provides a characteristic mass spectrum that positively identifies each compound. The Windows-based computer system provides quantitation and interprets the detector response. The computer system then compares the detector response with a calibration table constructed from standards of known concentration.

**Table 3-1. Viking SpectraTrak™ 672 Instrument Specifications. (Supplied by Viking Instruments Corporation.)**

Parameter	Developer's Specification
Detection limits	Down to low ppm air for direct injection (depending on analyte) Down to 5 ppb for air preconcentration Down to 5 µg/L purge and trap water samples Down to 5 µg/kg soil samples
Linear dynamic range	4 orders of magnitude
Mass range	1.6 - 700 amu
Analysis time	Direct injection, soil vapor, 10-15 min. Purge and trap for soil and water samples 30 to 40 min.
Weight	145 lbs
Size	14 in. high x 21 in. wide x 32 in. deep
Operator	1 operator (general GC/MS background), 1 week of training
Power requirement	1,300 W startup; 1,000 W during analyses
Support equipment	External roughing pump, 120 volts on AC power
On-Board Computer	Hewlett Packard 486 Personal Computer with Windows 3.1
Cost	\$145K

The unit requires an external mechanical roughing pump (or rough vacuum source) and an alternating current (AC) electrical power source. The AC source must be 110 v or 220 v, 50 to 60 Hz, with continuous power demand of approximately 1,000 W. The instrument requires about 1,300 W at start-up. An on-board helium carrier gas supply is contained in a pressurized cylinder that meets Department of Transportation (DOT) regulations for transportation. A fully pressurized cylinder typically operates for one week, depending on instrument usage.

The analytical system, including a high performance turbomolecular pump, is encapsulated in a shock-mounted transport case. When closed, the transport case protects the instrument from excess humidity and shock vibrations encountered during normal handling and shipment. The encased unit weighs approximately 145 lbs and is 14 in. high, 21 in. wide, and 32 in. deep. The closing of a vacuum isolation valve on the back of the unit allows the system to be transported with the vacuum intact. Transporting under vacuum greatly minimizes start-up pump-down time, permitting rapid deployment from site to site.

### ***Performance Factors***

The following sections describe the Viking Instruments SpectraTrak™ 672 GC/MS performance factors. These factors include detection limits, dynamic range, and sample throughput.

## Detection Limits

Typically, detection limits, as summarized in Table 3-2, are in the low  $\mu\text{g}/\text{kg}$  range for soil and the low  $\mu\text{g}/\text{L}$  for water samples using relatively small sample volumes (1 to 5 g). Parts per trillion detection limits are possible for gaseous samples due to the ease of concentrating from a larger sample volume (1 to 10 L).

**Table 3-2. Detection Limits for the Viking SpectraTrak™ 672 GC/MS. (Supplied by Viking Instruments Corporation.)**

Analyte	Detection Limit *	Analyte	Detection Limit *
Chloromethane	10	Trichloroethene	5
Vinyl chloride	10	Bromodichloromethane	5
Chloroethane	10	cis-1,3-Dichloropropene	5
Bromomethane	10	trans-1,3- Dichloropropene	5
Acetone	100	1,1,2-Trichloroethane	5
1,1-Dichloroethene	5	Toluene	5
Methylene chloride	5	Dibromochloromethane	5
Carbon disulfide	100	Tetrachloroethene	5
Trans-1,2-Dichloroethene	5	Chlorobenzene	5
1,1-Dichloroethane	5	Ethylbenzene	5
2-Butanone	100	m+p-xylenes	5
Chloroform	5	Styrene	5
1,2-Dichloroethane	5	1,1,2,2-Tetrachloroethane	5
1,1,1-Trichloroethane	5	o-xylene	5
Carbon Tetrachloride	5	1,3- Dichlorobenzene	5
Benzene	5	1,4-Dichlorobenzene	5
1,2-Dichloropropane	5	1,2-Dichlorobenzene	5

\* Estimated detection limits. Units depend on sample preparation:  
 $\mu\text{g}/\text{kg}$  For 5 gram soil samples concentrated by purge and trap.  
 $\mu\text{g}/\text{L}$  For 5 mL water samples concentrated by purge and trap.  
 ppm For 250  $\mu\text{L}$  of air by direct injection.  
 ppb For 0.25 to 1.0 L of air concentrated onto sorbent tubes.

## Dynamic Range

Approximately 4 orders of magnitude linear dynamic range are possible with the Viking SpectraTrak™ 672 depending upon the analyte and analysis conditions.

## Sample Throughput

Sample throughput is a measure of the amount of time required to prepare and analyze one field sample. This, in turn, defines the number of samples that can be analyzed in one work day. Viking claims the complete analysis times as follows: direct injection for soil vapor, 10 to 15 minutes; purge and trap for soil and water samples, 30 to 40 minutes. This does not include sample handling, data documentation, or difficult dilutions and concentrations.

## Technology Advantages

Reliable on-site analyses provides timely information that is representative of actual site conditions. The timely results assist decision making and eliminate the need for costly and time consuming laboratory analyses.

The narrow-bore columns used on the SpectraTrak™ 672 provide faster VOC analysis than analyses performed on typical megabore columns. (Example: 12 minutes versus 30 minutes for EPA Method 8260 compounds.)

Other advantages of the technology include:

- Calibrations remain stable even after transporting the instrument, so more samples are analyzed per day;
- The dynamic range is linear across 4 orders of magnitude, depending on the compounds and experimental conditions;
- Columns can be installed without venting, so applications can be substituted with minimal time delays;
- Laboratory-quality performance in the field can be achieved; and,
- The technology is shock-mounted for field ruggedness and ease of transport.

### ***Technology Limitations***

Limitations of the technology include:

- GC columns with an inside diameter greater than 0.32 mm are not recommended for use in the SpectraTrak™ 672. Oven dimensions require that the columns be wound on a 3.5 inch diameter column cage. Wider bore columns may become brittle and break when wound to 3.5 inches in diameter;
- The system requires approximately 1.3 kW of power for operation. This may require the use of a portable generator for operation in the field; and,
- High initial capital costs. System costs with training are about \$150K<sup>3</sup>.

### ***Training Required***

A one-week training course is usually sufficient to learn the operations and effectively analyze samples on the SpectraTrak™ 672. However, training duration depends on the user's previous knowledge and experience. Users familiar with GC/MS and Hewlett Packard software can often run samples after one day of training.

### ***Sample Matrix Effects***

Sample matrix effects are deviations in observed instrument output caused by variations in the composition of the sample media. This effect can be pronounced when comparing different sample media such as gases, liquids, or soils. This effect can also be significant in a single media where the composition of the media

---

<sup>3</sup> The new SpectraTrak™ 572 model, introduced after this study, provides equivalent or better performance at a lower cost, starting from \$90,000. The new system is described in the Developer's Forum (Section 8).

can vary significantly. For example, the mineral composition of soils can vary greatly at a site, possibly affecting sample analysis results.

### *Spectral Interferences*

Interferences can occur in the presence of excessive water vapor or contamination resulting in altered detection limits and contamination build up. Instrumentation must be periodically checked by analyzing blanks for contamination to ensure there is no residual background contamination from sample to sample.

## **Section 4**

### **Site Descriptions and Demonstration Design**

This section provides a brief description of the sites used in the demonstration and an overview of the demonstration design. Sampling operations, reference laboratory selection, and analysis methods are also discussed. A comprehensive demonstration plan entitled "Demonstration Plan for the Evaluation of Field Transportable Gas Chromatograph/Mass Spectrometer" [SNL, 1995] was prepared to help guide the demonstration. The demonstration plan was designed to ensure that the demonstration would be representative of field operating conditions and that the sample analytical results from the field GC/MS technologies under evaluation could be objectively compared to results obtained using conventional laboratory techniques.

#### ***Technology Demonstration Objectives***

The purpose of this demonstration was to thoroughly and objectively evaluate field transportable GC/MS technologies during typical field activities. The primary objectives of the demonstration were to:

- To evaluate instrument performance;
- To determine how well each field instrument performed compared to reference laboratory data;
- To evaluate developer goals regarding instrument performance on different sample media;
- To evaluate adverse environmental effects on instrument performance; and,
- To determine the logistical and economic resources needed to operate each instrument.

In order to accomplish these objectives, both qualitative and quantitative assessments of each system were required and are discussed in detail in the following paragraphs.

#### **Qualitative Assessments**

Qualitative assessments of field GC/MS system capabilities included the portability and ruggedness of the system and its logistical and support requirements. Specific instrument features that were evaluated in the demonstration included: system transportability, utility requirements, ancillary equipment needed, the required level of operator training or experience, health and safety issues, reliability, and routine maintenance requirements.

#### **Quantitative Assessments**

Several quantitative assessments of field GC/MS system capabilities related to the analytical data produced by the instrument were conducted. Quantitative assessments included the evaluation of instrument accuracy, precision, and data completeness. Accuracy is the agreement between the measured concentration of an analyte in a sample and the accepted or "true" value. The accuracy of the GC/MS technologies was assessed by evaluating performance evaluation (PE) and media spike samples. Precision is determined by evaluating the agreement between results from the analysis of duplicate samples. Completeness, in the context of this demonstration, is defined as the ability to identify all of the contaminants of concern in the samples analyzed. Sites were selected for this demonstration with as many as fifteen contaminants to identify and analyze and with high background hydrocarbon concentrations. Additional quantitative capabilities assessed included field analysis costs per sample, sample throughput rates, and the overall cost effectiveness of the field systems.

#### ***Site Selection and Description***

Sandia National Laboratories and the EPA's National Exposure Research Laboratory/Environmental Sciences Division-Las Vegas (NERL/ESD-LV) conducted a search for suitable demonstration sites between January and May 1995. The site selection criteria were guided by logistical demands and the need



to demonstrate the suitability of field transportable GC/MS technologies under diverse conditions representative of anticipated field applications. The site selection criteria were:

- Accessible to two-wheel drive vehicles;
- Contain one or more contaminated media (water, soil, and soil gas);
- Provide a wide range of contaminant types and concentration levels to truly evaluate the capabilities and advantages of the GC/MS systems;
- Access to historical data on types and levels of contamination to assist in sampling activities;
- Variation in climatological and geological environments to assess the effects of environmental conditions and media variations on performance; and,
- Appropriate demonstration support facilities and personnel.

Several demonstration sites were reviewed and, based on these selection criteria, the U. S. Department of Energy's Savannah River Site (SRS) near Aiken, South Carolina, and Wurtsmith Air Force Base (WAFB) in Oscoda, Michigan, were selected as sites for this demonstration.

The Savannah River Site is a DOE facility, focusing on national security work; economic development and technology transfer initiatives; and, environmental and waste management activities<sup>4</sup>. The SRS staff have extensive experience in supporting field demonstration activities. The SRS demonstration provided the technologies an opportunity to analyze relatively simple contaminated soil, water, and soil gas samples under harsh operating conditions. The samples contained only a few chlorinated compounds (solvents) with little background contamination, but high temperatures and humidity offered a challenging operating environment.

WAFB is one of the Department of Defense's (DoD) National Environmental Technology Test Site (NETTS) test sites. The facility is currently used as a national test bed for bioremediation field research, development, and demonstration activities. The WAFB demonstration provided less challenging environmental conditions for the technologies but much more difficult samples to analyze. The soil, water, and soil gas samples contained a complex matrix of fifteen target VOC analytes along with relatively high concentration levels of jet fuel, often about 100 times the concentration levels of the target analytes being measured.

### **Savannah River Site Description**

Owned by DOE and operated under contract by the Westinghouse Savannah River Company, the Savannah River Site complex covers 310 square miles, bordering the Savannah River between western South Carolina and Georgia as shown in Figure 4-1.

The Savannah River Site was constructed during the early 1950's to produce the basic materials used in the fabrication of nuclear weapons, primarily tritium and plutonium-239. Weapons material production at SRS has produced unusable byproducts such as intensely radioactive waste. In addition to these high-level wastes, other wastes at the site include low-level solid and liquid radioactive wastes; transuranic waste;

---

<sup>4</sup> Much of this site descriptive material is adapted from information available at the Savannah River Site web page (<http://www.srs.gov/general/srs-home.html>)

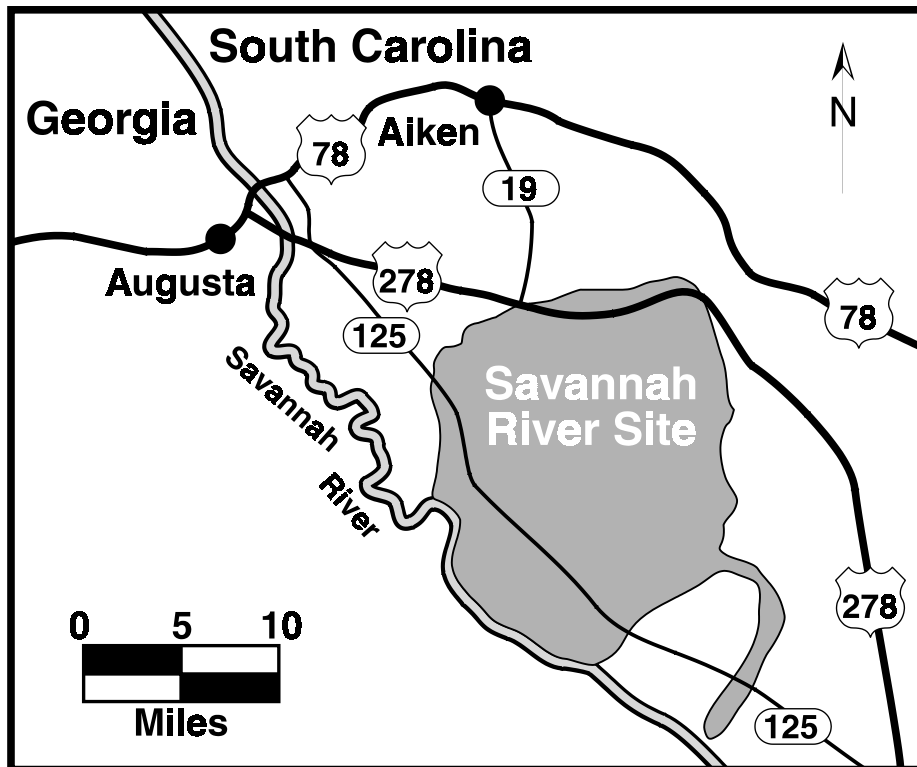

Figure 4-1. Location of the Savannah River Site.

hazardous waste; mixed waste, which contains both hazardous and radioactive components; and sanitary waste, which is neither radioactive nor hazardous. Like many other large production facilities, chemicals have been released into the environment during production activities at SRS. These releases and the common disposal practices of the past have resulted in subsurface contamination by a variety of compounds used in or resulting from production processes.

***SRS Geologic and Hydrologic Characteristics***

The facility is located on the upper Atlantic coastal plain on the Savannah River, approximately 30 miles southeast of Augusta, Georgia and about 90 miles north of the Atlantic coast. The site is underlain by a thick wedge (approximately 1,000 feet) of unconsolidated Tertiary and Cretaceous sediments that overlay the basement which consists of Precambrian and Paleozoic metamorphic rocks and consolidated Triassic sediments (siltstone and sandstone). The younger sedimentary section consists predominantly of sand, clayey sand, and sandy clay.

Ground water flow at the site is controlled by hydrologic boundaries. Flow at or immediately below the water table is predominately downward and toward the Savannah River. Ground water flow in the shallow aquifers in the immediate vicinity of the demonstration site is highly influenced by eleven pump-and-treat recovery network wells.

***SRS Demonstration Site Characteristics***

Past industrial waste disposal practices at the Savannah River Site, like those encountered at other DOE weapons production sites, often included the release of many chemicals into the local environment. These releases and early disposal practices have resulted in the contamination of the subsurface of many site areas by a number of industrial solvents used in, or resulting from the various weapons material production processes. The largest volume of contamination has been from chlorinated volatile organic compounds.

The primary VOCs encountered at SRS include: tetrachloroethene (PCE), trichloroethene (TCE), trichloroethane (TCA), Freon 11, and Freon 113.

The area selected for the demonstration is designated the M-Area. The M-Area is located in the northwest section of SRS and consists of facilities that fabricated reactor fuel and target assemblies for the SRS reactors, laboratory facilities, and administrative support facilities. Operations at these and other facilities resulted in the release of the chlorinated solvents previously mentioned. The releases have resulted in the contamination of soil and ground water within the area. The technology staging site was located near an abandoned process sewer line which carried waste water from M-Area processing facilities to a settling basin for 27 years, beginning in 1958. Site characterization data indicate that several leaks existed in the sewer line, located about 20 feet below the surface, producing localized sources of contamination. Although the use of the sewer line was discontinued in 1985, estimates are that over 2 million pounds of these solvents were released into the subsurface during its use.

Typical PCE and TCE concentrations are listed in Table 4-1 for the demonstration wells identified in Figure 4-2. The soil and underlying sediments at the demonstration site are highly contaminated with chlorinated solvents at depths in excess of 50 feet. Identification of the contaminant concentration levels in the soil and sediments has been complicated by the nature of these media at SRS. They have very low organic content, resulting in significant contaminant loss during typical sampling operations. These sampling concerns and limitations, and their influence on the demonstration, are discussed in detail later in this section.

**Table 4-1. PCE and TCE Concentrations in SRS M-Area Wells.**

Conc. Level	Water			Soil Gas		
	Well	PCE (µg/L)	TCE (µg/L)	Well	PCE (ppm)	TCE (ppm)
Low	MHT-11C	12	37	MHV-2C	10	5
Medium	MHT-12C	110	100	CPT-RAM 15	80	50
High	MHT-17C	3700	2700	CPT-RAM 4	800	350

### **Wurtsmith Air Force Base Description**

Wurtsmith Air Force Base covers approximately 7.5 square miles and is located on the eastern side of Michigan's lower peninsula on Lake Huron, about 75 miles northeast of Midland, Michigan, near the town of Oscoda (Figure 4-3). It is bordered by three connected open water systems; Lake Huron to the east, shallow wetlands and the Au Sable River to the south, and Van Etten Lake to the north. State and National Forest lands surround much of the base. WAFB began operations as an Army Air Corps facility, known as Camp Skeel, in 1923. It was originally used as a bombing and artillery range and as a winter training facility. The WAFB was decommissioned in 1993 and is currently being used as a national test bed for bioremediation field research, development, and demonstration. The National Center for Integrated Bioremediation Research and Development (NCIBRD) of the University of Michigan coordinates these bioremediation activities. Several contaminant features consistent with its history as an Air Force base have been identified at WAFB. These include landfills with mixed leachate, gasoline and jet fuel spills, a fire fighting training area, leaking underground storage tanks, an airplane crash site, and pesticide contamination.

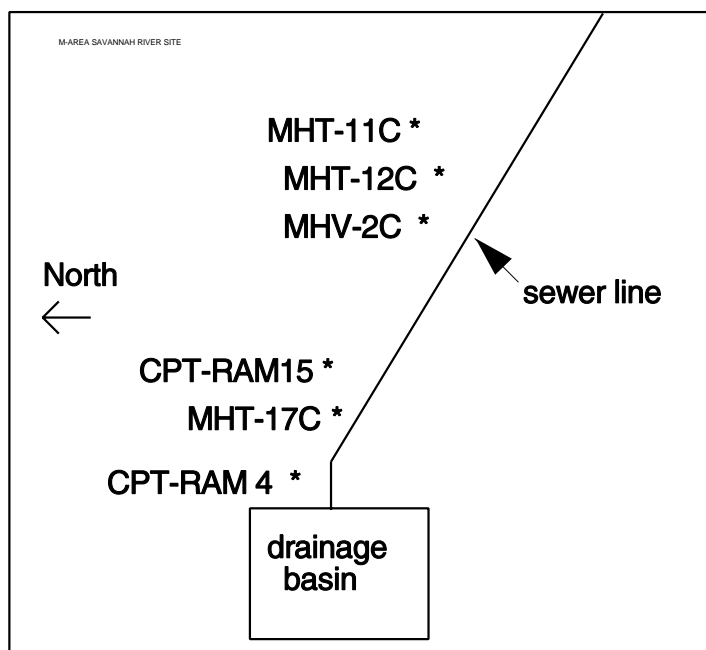

Figure 4-2. SRS M-Area Well Locations.

Contamination has spread to soil and ground water under approximately 20 percent of the base. A number of VOC contaminants, some of which are identified in Table 4-2, are commingled at the site. The ground water contaminants include: chlorinated solvents such as DCE, TCE, PCE and chlorobenzenes; polycyclic aromatic hydrocarbons (PAHs); aromatic hydrocarbons such as benzene, toluene, ethylbenzene, and xylenes (BTEX); and, other hydrocarbons such as aldehydes, ketones, gasoline, and jet fuel. Many of the VOC contaminants are found in the capillary fringe at the water table as part of a non-aqueous or free phase hydrocarbon medium. Contaminant concentration levels in this medium can be several orders of magnitude higher than in the ground water. Current remediation efforts at WAFB include three pump-and-treat systems using air strippers.

Table 4-2. Historical Ground Water Contamination Levels at WAFB.

Conc. Level	DCE	TCE	PCE	Benz.	Ethyl Benz.	Tol.	Xyl.	Chlorobenzene	DCB
Low	<1	<1	<1	<1	<1	<1	<1	<1	<1
Med	200	<1	<1	20	300	10	200	5	5
High	700	2	<1	250	1200	400	600	30	20

Note: Concentration levels in  $\mu\text{g/L}$ .

#### WAFB Geologic and Hydrologic Characteristics

The WAFB site rests on a 30-80 ft. thick layer of clean, medium-grained sand and gravel sediments formed by glacial meltwater, channel, deltaic and upper shore face-beach depositional processes. This surface layer is underlain by a 100-250 ft. thick layer of silty-clay deposited through settlement of the silt and clay-sized particles from glacial meltwater following glacier retreat after the glacial episodes of the Pleistocene Epoch. This layer lies on top of bedrock that consists of Mississippian sandstone and shale formations that have a structural dip to the southwest into the Michigan Basin. The water table ranges from about 5 feet below land surface in the northern regions to 20 feet below land surface in the southern regions. A ground water divide runs diagonally across the base from northwest to southeast. South of the

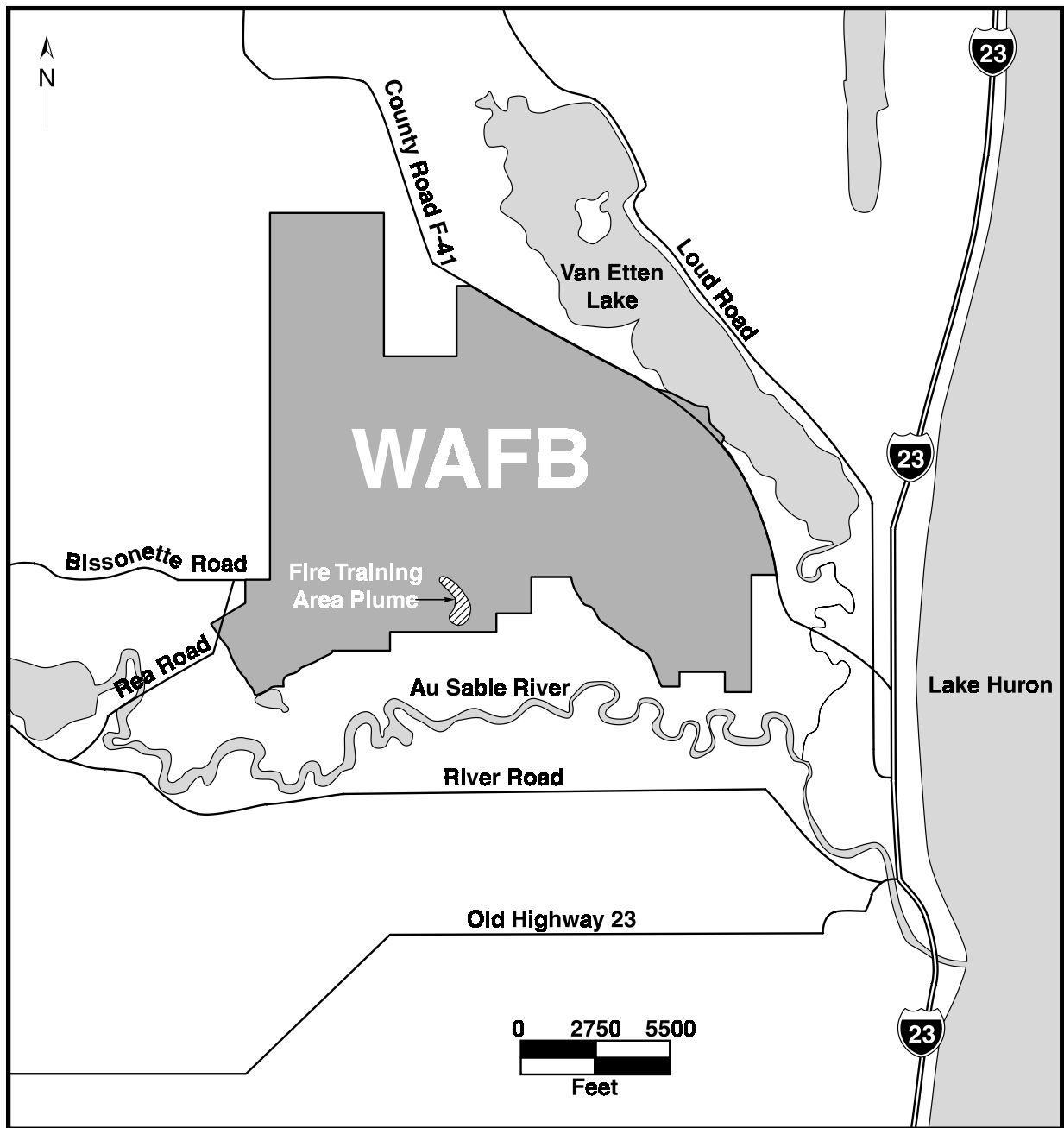

Figure 4-3. Location of Wurtsmith Air Force Base.

divide, ground water flows toward the Au Sable River, and north of the divide, toward Van Etten Creek and Van Etten Lake. Eventually, all water from WAFB reaches Lake Huron.

**WAFB Demonstration Site Characteristics**

The demonstration area selected is located at the former Fire Training Area 2, near the southern boundary of the base (Figure 4-4). A wide range of organic contaminants from former fire training and other activities exist in the soil and ground water at the site. Based on historic data, over fifteen organic contaminants exist at the site. Additionally, high background levels of petroleum hydrocarbons such as jet and diesel fuel exist at the site. Historic contaminant concentration levels are listed in Table 4-3 for the monitoring wells at the Fire Training Area. The monitoring wells at this site are often clustered together

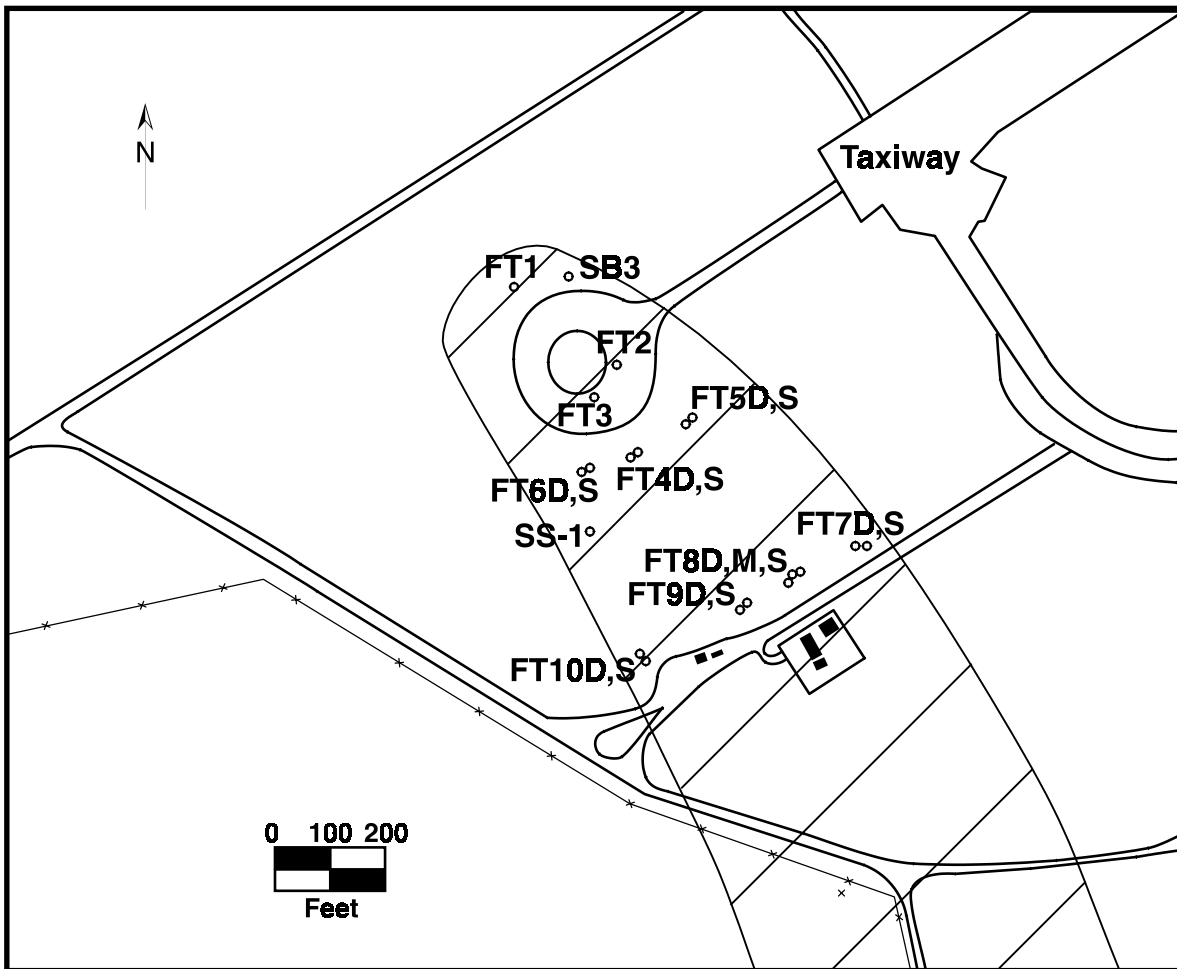

Figure 4-4. WAFB Fire Training Area 2 Sampling Locations. The cross-hatched region shows the approximate location of the below-ground contaminant plume. A number of deep (D), medium (M), and shallow (S) well locations are also shown.

Table 4-3. VOC Concentrations in WAFB Fire Training Area 2 Wells.

Conc. Level	Water				Soil Gas	
	Well	Benzene ( $\mu\text{g/L}$ )	Toluene ( $\mu\text{g/L}$ )	Xylenes ( $\mu\text{g/L}$ )	Well	Total VOCs (ppm)
Low	FT5S	0.24	0.20	20	SB3 at 4'	30
Medium	FT3	20	15	400	SB3 at 7'	55
High	FT8S	225	2	1800	SB3 at 10'	62

with one well screened at a shallow depth, denoted by an (S), and one screened at a deeper depth denoted by a (D). No historical data regarding the expected soil contamination levels were available for the site.

### ***Overview of the Field Demonstrations***

The demonstrations were designed to evaluate both the analytical and operational capabilities of the field GC/MS technologies under representative field conditions. The analytical method for the operation of the SpectraTrak™ 672 is provided in Appendix A. The SRS field demonstration was conducted in July 1995 and lasted three days. The technologies arrived at the demonstration site on Monday, July 17. As is

typically the case for this part of the country in mid-summer, the weather was hot (up to 95°F) and humid but with no rain. Each day the technologies arrived at the site about 6:30 a.m. They were set-up, calibrated, and ready for sample analysis by about 7:30 a.m. Sample analysis typically lasted through mid-afternoon. Soil vapor samples were prepared and analyzed on-site by the participants on Tuesday, July 18. The water and soil samples were collected and analyzed by the participants on Wednesday and Thursday, respectively. Each developer provided their own transportation, personnel, and equipment needed to conduct their analyses. At SRS, the developers were required to provide their own electrical power as part of their field operations. The field demonstration was completed by Friday, July 21.

The WAFB field demonstration was conducted in September 1995. The participants arrived at the demonstration site on Sunday, September 10. The weather was generally cool, typically 40°F in the mornings, warming to about 70°F during the afternoons. No appreciable precipitation was encountered during the demonstration. Each participant arrived with their respective instrument early in the morning. Following set up and calibration, instruments were ready for sample analysis by 7:30 a.m. Sample collection and on-site analysis took three days, one day for each media. A fourth day was used as a “media day” to showcase the participating technologies. As at SRS, each developer provided their own transportation, personnel, equipment, etc., to conduct the sample analyses.

The Viking system is compact and rugged and was moved daily to and from each site in the back of a passenger vehicle. Since it is essentially self-contained, it did not require a dedicated support vehicle. The Viking system required an external roughing pump and printer for the field operations. At the SRS site, where no field power was available, a small generator was used. At both demonstration sites the system was operated by one technician, who analyzed as many as thirteen samples a day and provided the results of the analyses at the end of each day. The system was able to analyze all the samples provided each day at both demonstration sites with no operational or mechanical problems.

### ***Overview of Sample Collection, Handling, and Distribution***

Soil gas, water, and soil samples were collected during the demonstrations at both sites. Sample splits were provided to the technology developers for on-site analysis the day of the sampling and shipped to reference analytical laboratories for analysis using conventional methods. Formal chain-of-custody forms were used for distribution of the samples to each of the reference laboratories. The samples were collected, numbered, stored, and shipped to the laboratories in accordance with laboratory procedures that incorporate EPA sampling guidelines. Somewhat less formal chain-of-custody records were maintained for distribution of the samples analyzed on site. An overview of the site-specific sampling plans and the procedures for collecting, handling, and distributing the samples is presented below. Additional sampling details can be found in the demonstration plan referenced earlier. A description of the sampling terminology used in the context of this demonstration is presented in Table 4-4.

### **SRS Sample Collection**

A total of 33 samples were collected and analyzed in the SRS demonstration. The samples were distributed among the three sample media, soil gas, water, and soil, as identified in Table 4-5. Sample collection and on-site analysis took place over a three day period in July 1995. Water and soil gas samples were obtained from the six M-Area wells identified in Table 4-1. The principal analytes were TCE and PCE at concentration ranges noted in the table, but other contaminants such as TCA, Freon 11, Freon 113, and their degradation products were sometimes present at lower concentrations in the wells.

### ***SRS Soil Gas Survey***

Wells MHV-2C, CPT-RAM 15, and CPT-RAM 4 shown in Figure 4-2 were sampled using Tedlar bags and SUMMA<sup>®</sup> canisters. The Tedlar bags were used for on-site analyses and the SUMMA<sup>®</sup> canisters were

**Table 4-4. Sample Terminology and Description.**

<b>Term</b>	<b>Description</b>
Method Blanks	Method blanks are samples which do not contain the target analytes. Water blanks consisted of deionized water; Soil blanks consisted of uncontaminated soil representative of the site being sampled; Soil gas blanks consisted of dry nitrogen gas.
Spike Samples	Spike samples are generated by adding a known amount of analyte to a sample matrix. Spike samples are used to evaluate the accuracy of an instrument by comparing the concentration measured to the prepared reference concentration (spike recovery).
Performance Evaluation Samples	<p>Performance evaluation (PE) samples are samples having a certified concentration for specific analytes of interest. PE samples may include dilutions of a certified sample where so noted. PE samples are also used to evaluate the accuracy of a technology or laboratory during sample analysis by comparing the measured concentration to the defined reference concentration.</p> <p>At both SRS and WAFB, water PE samples were obtained, diluted to appropriate concentrations, and submitted for analysis to the developers and the reference laboratories. At SRS, a soil vapor PE sample was generated using a VOC vapor standard from SRS. At WAFB, the soil PE samples were acquired in sealed vials and were submitted to the developers and laboratories. Each laboratory did their own dilutions as appropriate.</p>
Duplicate or Split Samples	A duplicate sample is a split of an initial sample. Duplicate samples are used to evaluate the precision of an instrument by comparing the relative difference between the duplicate measurements. For water and soil gas samples, a duplicate sample is often considered a second sample taken sequentially from the same well.

**Table 4-5. SRS Demonstration Sample Type and Count.**

<b>Media</b>	<b>Concentration Level</b>	<b>Samples</b>	<b>Duplicates</b>	<b>Spikes</b>	<b>PE Samples</b>	<b>Total</b>
Soil gas	Blank	2				13
	Low	1	1	1	1	
	Medium	1	1	1		
	High	1	1	1	1	
Water	Blank	2				13
	Low	1	1	1	2	
	Medium	1	1	1		
	High	1	1	1		
Soil	Blank	1				7
	Low			3		
	Medium					
	High			3		

sent to the reference laboratory for analysis. For the soil gas survey, soil vapor<sup>5</sup> from each well was

---

<sup>5</sup> A soil gas survey is conducted to measure the vapor phase concentration of VOC contaminants in a soil sample. This vapor phase contaminant concentration is commonly referred to as the soil gas concentration. The terms soil vapor and soil gas are used interchangeably in this report.



pumped sequentially into three Tedlar bags. The first bag was used to fill a SUMMA<sup>®</sup> canister while the other two bags were used for analysis by the developers. A sample aliquot was taken directly from the Tedlar bags by each developer for analysis on a round-robin basis.

Additional aliquots were taken by the SRS on-site laboratory prior to and following drawing developer samples from each bag in order to monitor the stability of both TCE and PCE in the bags during the analysis. A blank sample, a Tedlar bag filled with nitrogen, was provided to participants at the beginning and another blank provided at the end of the analyses. Spike samples were prepared by the SRS on-site laboratory by injecting a known volume of TCE and PCE into a Tedlar bag filled with a known volume of nitrogen. Two gas PE samples from certified cylinders were metered into Tedlar bags for analysis by the participants. Sample aliquots were also taken by the developers from each of the PE and blank sample bags on a round-robin basis.

### ***SRS Water Sampling***

Water samples were collected from wells MHT-11C, MHT-12C, and MHT-17C (Figure 4-2). Each well was initially purged and a 2 liter sample collected. Immediately after collection, the sample was sealed and stirred for 10 minutes. The homogenized sample was then split into individual sample vials for distribution and analysis. The type of sample depended on the requirements of each technology, with the Viking receiving their samples in 40 mL volatile organic analysis (VOA) vials. Two blank samples consisting of deionized water were provided to the participants for analysis. Two water PE samples, prepared for the EPA's Hazardous Substances Evaluation Division in Washington, DC for use in the Contract Laboratory Program, were also provided to the participants for analysis. For on-site analysis, the PE sample ampules were mixed with the appropriate volume of water to obtain the defined reference concentration. For the reference laboratory analysis, the ampules were provided directly to the laboratories without prior dilution.

### ***SRS Soil Spike Samples***

Soils and sediments at the demonstration site are highly contaminated with PCE and TCE. Accurate analyses of the sediments at depths greater than 50 feet, where contaminant levels appropriate to the requirements of this demonstration exist, have been difficult because the SRS soils have low organic content and the VOCs do not bind well to the soil matrix. The expense of drilling and sampling at these depths and the composition of the soil at the site indicated that collecting standard soil core samples for analysis was inappropriate for this demonstration. In order to maximize the amount of data that could be derived from the demonstration under these circumstances, the demonstration plan contained a procedure for using spiked soil samples in the place of soil core samples. This procedure called for soil to be collected from an erosion pit at SRS, homogenized, spiked with solutions of TCE and PCE, separated into 5-gram portions, and placed in 40 mL VOA vials equipped with screw-top lids and septa. This vial configuration allowed participants the option of either purge and trap or head space sample introduction and analysis. Actual sample preparation was done differently from that presented in the demonstration plan. These deviations are discussed later in this section.

### ***SRS Sample Handling, Storage, and Shipping***

Developers analyzed the samples as soon as practical following collection or preparation, but generally within an hour of sampling. Formal chain of custody protocol was maintained for the reference laboratory samples. The field-analyzed samples had less formal custody procedures, but all transfers were recorded in log books. Samples collected for laboratory analysis were transported to the reference laboratory at the end of each day. Possible loss of VOCs in the samples was a major concern; therefore, all water, soil vapor, and soil samples were stored and shipped in coolers maintained at approximately 40°F.

## WAFB Sample Collection

A total of 37 samples were collected and analyzed in the WAFB demonstration. The distribution of the samples from each media, soil, water, and soil gas are presented in Table 4-6. Sample collection and on-site analysis took place over a three day period in September 1995. Water and soil gas samples were obtained from the wells identified in Table 4-3. Historical sampling and analysis data show VOC concentrations ranging from 0.2 to 1800  $\mu\text{g/L}$  in water and total VOC concentrations in soil gas ranging from 30 to 62 ppm.

**Table 4-6. WAFB Demonstration Sample Type and Count.**

Media	Concentration Level	Samples	Duplicates	Spikes	PE Samples	Total
Soil gas	Blank	2				11
	Low	1	1	1		
	Medium	1	1	1		
	High	1	1	1		
Water	Blank	2			2	13
	Low	1	1	1		
	Medium	1	1	1		
	High	1	1	1		
Soil	Blank	2			2	13
	Low	1	2			
	Medium	1	2			
	High	1	2			

### *WAFB Soil Gas Survey*

Well SB3, shown in Figure 4-4, was sampled at three depths using Tedlar bags. At each depth, two bags were sequentially filled. The bags were used for on-site developer analyses and the residual gas in each bag was used to fill SUMMA<sup>®</sup> canisters for analysis by the reference laboratory. For on-site analysis, sample aliquots were drawn from the bags by each developer in a round-robin format like that used at SRS. A blank sample, a Tedlar bag filled with nitrogen, was used at the beginning and at the end of the soil gas analytical sequence. A spiked sample for each concentration level was made by injecting a known volume of liquid into a Tedlar bag filled with a known volume of nitrogen.

### *WAFB Water Sampling*

Water samples were collected from wells FT5S, FT3, and FT8S (Figure 4-4). Each well was purged for ten minutes. Water samples were then drawn to sequentially fill standard 40 mL VOA vials. A blank sample consisting of deionized water was provided to each developer at the beginning and at the end of the analysis run. Two water PE samples were provided to each developer for analysis. Two samples were provided to each participant from each well for duplicate analysis.

### *WAFB Soil Sampling*

Three soil samples were obtained as sub-cores from a sediment boring taken with a two-inch diameter Geoprobe at a location 100 feet south of well FT6, identified as SS-1 in Figure 4-4. On-site photoionization detector readings taken while drilling allowed the core sample to be subdivided into segments having varying levels of VOC contamination. The three segments, 8 to 9, 9 to 10, and 10 to 11 feet below the surface, were each homogenized, split, and placed in vials. All soil samples were weighed using a calibrated balance. The reference laboratory and each developer received splits from the homogenized samples for analysis. Two soil PE samples,

prepared by the Army's Cold Regions Research and Engineering Laboratory in Hanover, New Hampshire were also provided to the participants for analysis.

### ***WAFB Sample Handling, Storage, and Shipping***

After the water and soil samples were collected, they were placed in a cooler containing double-bagged ice to maintain an approximate 40°F temperature. The water samples sent to the reference laboratory were preserved with 1 percent sodium bisulfate (NaHSO<sub>4</sub>), and placed in an ice-filled cooler for storage and shipment. The soil gas samples for reference laboratory use were transferred to SUMMA<sup>®</sup> canisters for shipment to the laboratory. All reference laboratory samples were picked up by the laboratories at the end of each day. All samples collected for on-site analysis during the demonstration were presented to the developers for analysis as soon as practical. Analysis always occurred on the day of sample collection and often within an hour of collection.

### ***Reference Laboratory Selection and Analysis Methodology***

One objective of this demonstration was to determine how well each developer's field instrument performed in comparison to conventional laboratory methods and protocols. Standard analytical methods applicable to the sample media and analytes of interest in these demonstrations were selected as the standard of comparison. These include EPA SW-846 Method 8260 *Gas Chromatography/Mass Spectroscopy for Volatile Organics: Capillary Column Technique* for water and soil analyses, and EPA Compendium Method TO-14 *The Determination of Volatile Organic Compounds in Ambient Air Using Summa Passivated Canister Sampling and GC/MS Analysis* for soil gas analyses.

The selection of reference analytical laboratories for this demonstration was based on consideration of several criteria including:

- Certification in one or more states;
- Recommendation from the site manager of prior use;
- Proximity to the site (generally within 3 hours driving time) to minimize sample transport and handling;
- Proven capability to measure VOCs at the required concentration ranges in the appropriate media and in accordance with the selected analytical methodologies as determined from a review of quality assurance (QA)/quality control (QC) data results;
- Proven capability to provide an analytical data package consistent with the requirements of Method 8260 and TO-14 as determined by a review of QA/QC data results; and,
- Passing a pre-demonstration audit by Sandia that included a review of facilities, personnel, QA/QC procedures, protocols, and overall operations.

Based on recommendations from each of the sites, several analytical laboratories were identified for possible use as reference laboratories for the demonstration. Each laboratory identified was asked to provide information on its QA/QC procedures and sample analysis data, using the same methods, for review. Based on a review of this information, discussions with the site managers, and discussions with other users, three laboratories were identified for further evaluation. These were the General Engineering Laboratory, Inc. for the SRS demonstration, and Traverse Analytical Laboratory and Pace Incorporated Environmental Laboratories for the WAFB demonstration.

Further evaluation included a pre-demonstration audit of each of the laboratories. Each pre-demonstration audit included meeting with laboratory personnel; touring the facility; and reviewing laboratory operations, personnel qualifications, and laboratory QC procedures. Chain of custody procedures, sample holding areas and procedures, and analytical equipment operation were also reviewed. During the Traverse pre-demonstration audit, it was determined that soil gas analysis was not routinely conducted at their laboratory and that Traverse

commonly subcontracted soil gas analyses to Pace. Therefore, Pace was considered for soil gas analysis for the WAFB demonstration and was audited in the same manner as GEL and Traverse.

### **General Engineering Laboratory**

General Engineering Laboratory (GEL) is located in Charleston, South Carolina, and is certified in South Carolina, Georgia, Alabama, and Florida. This laboratory is close to SRS and has been used extensively by SRS to analyze environmental site characterization and monitoring samples. GEL provided QA/QC documentation of their operations for review. Based on the results of the pre-demonstration audit, GEL was found to conduct their analyses in accordance with the analytical methods identified for this demonstration and was selected as the reference laboratory for the SRS demonstration. GEL personnel picked up and transported samples daily to their laboratory in Charleston and performed the analyses for all three media. The final data packages provided also included the corresponding QC results.

### **Traverse Analytical and Pace Environmental Laboratories**

Traverse Analytical Laboratory is located in Traverse City, Michigan, and is certified by the state of Wisconsin. Michigan has no laboratory certification program. This laboratory is close to WAFB and had been previously used by WAFB for environmental sample analysis. Traverse provided QA/QC documentation of their operations for review. The pre-demonstration audit by Sandia determined that their analyses were conducted in accordance with the analytical methods identified for this demonstration. Based on these audit results, Traverse was selected as the reference laboratory for soil and water analyses for the WAFB demonstration.

Traverse suggested that Pace in Camarillo, California, conduct the soil gas analyses for the WAFB demonstration. Pace provided QA/QC documentation on their analytical procedures for review. Based on the pre-demonstration audit of the laboratory by Sandia, they were found to conduct their analyses in accordance with the analytical methods identified and were selected as the reference laboratory for soil gas analysis for the WAFB demonstration. Traverse personnel picked up and transported samples daily to their laboratory and conducted the analyses on the water and soil samples. The soil gas samples were shipped from Traverse to Pace for analysis. Both laboratories provided data packages with accompanying QC results.

### **SRS and WAFB On-Site Laboratories**

In addition to the selected reference analytical laboratories, the on-site laboratories at both SRS and WAFB provided rapid analyses to confirm general sample integrity and to ensure that the samples collected contained the expected levels of contamination. Both on-site laboratories use gas chromatograph systems for routine sample analysis. The laboratory analytical methods and corresponding QC protocol were reviewed by Sandia to confirm their use of acceptable laboratory procedures.

### ***Pre-demonstration Sampling and Analysis***

Pre-demonstration sampling and analysis were conducted at both demonstration sites to establish that samples from the sites were appropriate for analysis by the GC/MS technologies and that the technology results could be objectively compared to reference laboratory data. The pre-demonstration activities allowed the technology developers an opportunity to refine their systems, revise operating procedures as necessary, and evaluate media effects or interferences that could influence their analytical results. The pre-demonstration sampling events required one field day at each site and took place on June 5, 1995 at SRS and on July 30, 1995 at WAFB.

The pre-demonstration samples consisted of one SUMMA<sup>®</sup> canister of soil gas from a medium-concentration soil gas well at each site (CPT-RAM 15 at SRS and SB3 at WAFB), and three water samples from a medium-concentration well (MHT-12C at SRS and FT4S at WAFB). No pre-demonstration soil samples were provided for developer analysis from either site. The soil gas and water samples were split and sent to the developers and the respective reference laboratories for analysis. The reference laboratories used EPA Compendium Method

TO-14 for soil gas analysis and EPA SW-846, Method 8260 for water analysis. Unfortunately, the results from these laboratory analyses were not available prior to the SRS demonstration to help guide the technology developers. The SRS and WAFB pre-demonstration sample analytical results were available to assist the developers prior to the WAFB demonstration. No interpretation or analysis of the analytical results was conducted since these data were intended primarily to assist the developers in refining their operations and procedures for this demonstration.

### ***Deviations from the Demonstration Plan***

Several deviations from the demonstration plan occurred as the demonstrations progressed and are discussed below.

#### **Pre-demonstration Activities**

The pre-demonstration activities identified in the demonstration plan called for analysis of pre-demonstration samples to allow the technology developers to refine their methodologies, revise operating parameters, and identify matrix effects or interferences. Pre-demonstration sample analytical results from the reference laboratory were not available prior to the SRS demonstration. Also, no soil samples from either site were provided for evaluation of media effects. The omission of pre-demonstration soil sampling at SRS led to soil sampling problems at SRS during the demonstration.

#### **SRS Soil Spike Samples**

A number of deviations occurred in the soil sample preparation procedures used during the SRS demonstration. The demonstration plan deviations were not discovered until the day of the sample analysis. Consequently, new soil spike samples could not be prepared in the allotted time. These deviations in sample preparation were judged to be significant. Consequently, no assessment or comparison can be made between the Viking GC/MS and the reference laboratory on the results of soil sample analyses.

#### **SRS Soil Gas Survey Evaluation**

Of the thirteen soil vapor samples analyzed by GEL, ten were reported as estimated values. In particular, these data were obtained by extrapolation of the calibration curve beyond the normal calibration range of the laboratory instrument used for analysis. This deviation is significant in that no quantitative information on laboratory precision or accuracy can be derived from such data. Consequently, the GEL soil gas data were not used as a reference data set for comparison with the Viking GC/MS data.

#### **Soil Gas Samples at WAFB**

No initial or final analysis of each Tedlar bag gas sample was conducted by the field laboratory as called for in the demonstration plan. Therefore, no data are available on the stability of the vapor sample in these bags during the round-robin sampling and analysis by the developers. Based on the results from a similar analysis at SRS where the vapor sample was determined to be very stable, this is not considered a significant deviation.

Condensation was noted by the participants in the Tedlar bags from the well samples. It was not possible to determine if this was liquid contaminant or simply water condensation from the samples given that the ambient air temperatures during the morning of the sampling was below the soil temperatures in the sampling well. In either case, the analytical results from these samples could differ as a result of variation in the vapor phase sample constituent concentrations over the sample handling and transfer interval. No determination could be made of the significance of the condensation and its effect on the analytical results.

Appropriate soil gas PE samples could not be obtained from suppliers in time for the WAFB demonstration. Consequently, the number of samples to evaluate laboratory and developer accuracy was limited. To minimize the significance of this deviation, the number of spike samples prepared on-site was increased.

### **Water Samples at WAFB**

The compound 1,4-difluorobenzene was included in the spike mixture used for water samples at WAFB. This compound is normally used as a Method 8260 internal standard by the Traverse reference laboratory. Inclusion of this compound in the spike mixture required the reference laboratory analyst to revert to an external standard method for quantitative measurements of 1,4-difluorobenzene in the spike samples. Reference laboratory data quality was not adversely impacted by use of the external standard method.

### **Calibration Check Sample Analysis**

The demonstration plan called for the participants to run calibration check samples throughout the day in order to facilitate the assessment of instrument stability. Given the intensity of the schedule for analyzing the samples as quickly as they were distributed, periodic analysis of calibration check samples was not completed. These data are used by the instrument operator to ensure optimum instrument performance. The calibration data were not used in the evaluation of instrument performance. This deviation was not considered significant.

## **Section 5**

### **Reference Laboratory Analysis Results and Evaluation**

An important objective of this demonstration was to provide the technology developers with a validated data set from conventional laboratory analyses of water, soil, and soil gas samples. Validated laboratory results are essential for direct comparison with the analytical results from the field methods under evaluation. This section describes a number of qualitative and quantitative data quality indicators that were used to evaluate and validate the analytical results from the reference laboratories. Qualitative factors reviewed included adequacy of laboratory QA/QC procedures and deviations from standard procedures. Quantitative factors reviewed included accuracy and precision of the reference laboratories' analyses of reference samples. The laboratories evaluated were the General Engineering Laboratories for the Savannah River Site demonstration, and the Traverse Analytical Laboratory and Pace Inc. Environmental Laboratories for the Wurtsmith demonstration. The on-site SRS laboratory was evaluated to a limited extent as a result of some data limitations encountered with GEL. The National Center for Integrated Bioremediation Research and Development laboratory was used as an on-site screening laboratory and not in a reference capacity at the Wurtsmith demonstration. Consequently, no formal data quality evaluation was done for this laboratory.

#### ***Laboratory Operations***

##### **General Engineering Laboratories**

Prior to the demonstration, GEL provided a quality assurance plan that described laboratory and personnel capabilities, analytical methods, and internal quality control procedures. A complete description of the analytical methods used in the soil, water, and soil gas sample analysis was also included in their plan. The laboratory quality assurance plan was prepared using EPA guidance [U.S. EPA, 1991]. Water and soil analyses were done using EPA SW-846, Method 8260 for purge and trap GC/MS. Soil gas analysis followed EPA Compendium Method TO-14. A number of laboratory performance quality control indicators were provided in the data package including: daily mass spectrometer tuning results, daily calibration check results, daily blank check results, continuing calibration check results, and surrogate compound recovery results.

##### **SRS On-Site Laboratory**

The SRS on-site laboratory was intended to provide rapid on-site analysis to assist in determining sample integrity during the demonstration, and was not identified as a reference laboratory in the demonstration plan. Analyses were conducted using a Hewlett Packard 5890 GC with flame ionization and electron capture detectors. Water samples were analyzed using headspace methods, while the soil gas analysis followed EPA Method TO-14. All samples were analyzed on-site the day of the sampling. No formal QA/QC plan was obtained from the SRS laboratory prior to the demonstration. When SRS data were recognized as a possible replacement for GEL data, an informal quality control package was obtained from laboratory personnel that documented the calibration performance of the GC system for several months prior to the demonstration.

##### **Traverse Analytical Laboratory**

Prior to the demonstration, Traverse provided a complete quality assurance plan much like that submitted by GEL. Water and soil analyses were conducted using EPA SW-846, Method 8260 for purge and trap GC/MS and samples were analyzed within 14 days of receipt. As a result of equipment limitations, Traverse did not conduct any soil gas analyses. Instead, this activity was subcontracted to Pace Inc. Environmental Laboratories. A number of laboratory performance quality control indicators were provided in the Traverse data package including: mass spectrometer tuning results, daily calibration check results,

blank check results, continuing calibration check results, internal duplicate analysis data, and surrogate recovery analysis data on selected compounds.

**Pace Inc. Environmental Laboratories**

Pace conducted soil gas analysis for the Wurtsmith demonstration under contract to Traverse. Prior to the demonstration, Pace provided a complete QA package similar to those provided by the other reference laboratories. Complete method descriptions were also given in the QA/QC plan. The analyses were carried out in accordance with EPA Method TO-14. A number of internal laboratory quality control indicators, including blank and internal laboratory gas spike analytical results, were provided in the data package.

**WAFB On-Site Laboratory**

The on-site laboratory at WAFB is the NCIBRD Field Laboratory. The function of this laboratory was much like that of the on-site SRS laboratory during the SRS demonstration. The laboratory was used primarily for on-site, quick-turnaround analyses to help in the assessment of field sample integrity prior to distribution to the participants. Water analyses were conducted using a Perkin-Elmer gas chromatograph with a Tekmar 2016 purge and trap system following EPA Method 502. Samples were analyzed on-site the day of sample collection. A photoionization detector was used for on-site soil gas screening prior to sample distribution to the participants. Soil sample analysis was not conducted by this laboratory.

**Laboratory Compound Detection Limits**

Detection limits for various compounds are identified for each EPA method. These limits vary both by compound and sample media type. Each of the data packages provided by the reference laboratories defined practical quantitation limits (PQL) for each media and analyte. The PQL is defined as the level at which instrument noise and method inaccuracies have negligible effects on the accuracy and precision of the analytical results. This value is commonly considered to be about three times higher than the method detection limit. The PQLs for each of the laboratories are presented in Table 5-1. Although the PQLs are analyte and method specific, this table is provided to illustrate the range of PQLs for all target analytes in the three media for each of the four laboratories generating reference data used in this demonstration.

**Table 5-1. Reference Laboratory Practical Quantitation Limits.**

Laboratory	Media	PQL
GEL	Water	2 µg/L
	Soil Gas	10 ppb
	Soil	100 µg/kg
SRS	Water	2 µg/L
	Soil Gas	10 ppb
	Soil	100 µg/kg
Traverse	Water	1 µg/L
	Soil	100 µg/kg
Pace	Soil Gas	10 ppb

**Laboratory Data Quality Assessment Methods**

All analytical data are subject to some level of inaccuracy and imprecision. This section discusses the methods used in determining the level of confidence placed in the analytical results from the reference laboratories participating in these demonstrations.

**Precision Analysis**



Precision is a measure of the degree to which repeated analytical measurements of the same sample agree with one another. In the context of this study, precision is indicative of the random errors associated with the measurement process and is intended to yield a measure of the variability encountered in the normal operation of a laboratory or field instrument. In the absence of any inaccuracy or bias in a measurement, repeated determinations of a given analyte in a single sample will be evenly distributed above and below the analyte's true concentration, and the average of several measurements will be a better estimation of the true value than is any individual measurement. A simple way to express precision for duplicate measurements is *relative percent difference* (RPD), which is defined as follows:

$$RPD = \frac{|x_1 - x_2|}{\bar{x}} \cdot 100$$

where  $x_1$  and  $x_2$  are the duplicate measurements and  $\bar{x}$  is the average of  $x_1$  and  $x_2$ . The precision of reference laboratory measurements is assessed by using analytical results from duplicate field, PE, or spike samples. However, caution is warranted where sequential samples, often called duplicates, are drawn from a well. These sequential samples may not be equivalent and care must be taken in their evaluation as duplicates.

The standard methods employed in this demonstration generally call for RPD values of 20% or less as an indicator of acceptable analytical precision. In some sampling media these criteria are relaxed to values as high as 50% for selected compounds. The specific acceptance criteria are discussed in more detail in the sections dealing with the laboratory data evaluation.

### Accuracy Analysis

In the context of this demonstration, accuracy is defined as the agreement between the measured concentration of a reference sample and the accepted or "true" concentration of the sample. Bias is a term that is related to accuracy. Bias can be either positive or negative depending on whether the measured values are consistently higher or lower, respectively, than the true value, whereas accuracy is normally given in terms of absolute variation with no reference to positive or negative direction. An observed bias indicates the presence of systematic errors in the measurement process. For example, a calibration error in the setup of an instrument may produce a consistent negative or positive bias in the measurement results. Consistently lower values from a particular method may be indicative of evaporation losses, chemical reactions, biological degradation or other analyte loss mechanisms.

Accuracy is often reported in terms of percent recovery. The analysis result from a sample run on an instrument can be compared with the "true" or "reference" value of the sample and expressed in terms of *percent recovery* (REC). The percent recovery is computed as follows:

$$REC = \frac{x_{instrument}}{x_{reference}} \cdot 100$$

where  $x_{instrument}$  is the measured concentration by a field instrument and  $x_{reference}$  is the true concentration. The evaluation of accuracy is considerably more difficult than the evaluation of precision since there always exists some uncertainty in the "true" value of the reference material's concentration. While precision can be measured in the absence of information about the true concentrations, accuracy cannot be assessed without some level of confidence in the reference value used in the determination.

The accuracy of reference laboratory measurements is assessed by analyzing two types of reference materials, namely, performance evaluation (PE) samples and media spike samples. PE samples are typically purchased chemical standards with an accompanying certification of the chemical composition of the sample. In some cases, the PE samples require additional preparation in the field, for example, sample

dilution prior to distribution. Media spike samples are prepared by adding known quantities of the pure chemicals of interest to uncontaminated samples of the various media. For these demonstrations, the spike samples were prepared by the on-site laboratories and provided to all participants, including the reference laboratories, for analysis. The quality of the prepared media spikes must always be reviewed carefully because of the potential errors that can occur during their preparation. Since they are prepared in the field, a certificate of analysis is not available to confirm the composition of the sample.

Standard EPA methods such as TO-14 and 8260 indicate that appropriate recovery levels for the compounds of interest in this demonstration should generally be in the range of 80-120%. In some cases, the acceptable recovery level range is extended to 50-150% or greater depending on the nature of the media and the analyte. In most cases, these recovery levels are empirically derived by the laboratory during routine method use and are incorporated into the laboratory's QA plan. The specific acceptance criteria for each laboratory are discussed in more detail in the sections dealing with laboratory data evaluation.

### **Laboratory Internal Quality Control Metrics**

Each of the reference laboratories provided internal quality control data along with their analytical results. These data were used as one of several indicators of laboratory data quality. Specific laboratory internal quality control indicators that were evaluated are discussed below.

#### ***Blank Analysis***

The results from the analysis of blank samples are used primarily as a measure of instrument contamination and as a secondary check on compound detection limits for the laboratory instruments.

#### ***Continuing Calibration Check***

A continuing calibration verification procedure uses a calibration solution containing target analytes that is periodically analyzed during a sample batch analysis. The analysis results are recorded as a series of percent recoveries relative to the starting calibration value. The procedure gives an indication of the calibration or accuracy drift of the instrument over time. Control limits of  $\pm 25\%$  are normally applied for Method 8260 for water and soil and Method TO-14 for soil gas. Values falling outside these limits are suggestive of inadequate analytical process control and questionable data quality.

#### ***Internal Duplicate Analysis***

The standard methods for water, soil, and soil gas analysis require periodic duplicate analysis of both standards and field samples. These data provide a measure of laboratory precision, often expressed in terms of RPD, as described earlier. The methods used in this demonstration generally call for RPD values of less than 20% in a specified concentration range. For example, Method TO-14 indicates that the RPD for duplicate measurements must be within 20% only for those compounds detected at a level of 5 times greater than the instrument detection level for the compound of interest. Significant variations in duplicate sample measurements are indicative of inadequate analytical process control and questionable data quality.

### ***Laboratory Data Quality Levels***

Each of the reference laboratories data were evaluated and assigned one of three levels of data quality based on laboratory internal quality control, accuracy, and precision results. This ranking method identifies those laboratory data that do not meet commonly accepted data quality criteria and therefore are unsuitable or inappropriate for comparison with field technology data. The data quality levels are further described below:

## **Good Data Quality**

- Good laboratory internal quality control<sup>6</sup> results (e.g., internal blanks, duplicates, continuous calibration, and control samples);
- Analytical accuracy results, based on external (supplied by the project) PE and spike samples, consistently within  $\pm 30\%$  of the reference concentrations; and,
- Analytical precision results, as determined by RPD on duplicate samples, consistently less than 30%.

## **Satisfactory Data Quality**

- Satisfactory laboratory internal quality control<sup>7</sup> results;
- Analytical accuracy results, based on PE and spike samples, consistently within  $\pm 50\%$  of the reference concentrations; and,
- Analytical precision results, as determined by RPD on duplicate samples, consistently less than 50%.

## **Unacceptable Data Quality**

- Poor or missing internal quality control results; or,
- Analytical accuracy results, based on PE and spike samples, consistently exceeding  $\pm 50\%$  of the reference concentrations; or,
- Analytical precision results, as determined by RPD on duplicate samples, consistently exceeding 50%.

## ***Laboratory Data Validation for the SRS Demonstration***

### **GEL Data Quality Evaluation**

GEL QA/QC procedures were audited by Sandia personnel prior to the demonstration and were found to be operating in accordance with accepted good laboratory practice and the requirements outlined in the standard methods used in analysis of these demonstration samples. GEL analyzed all three sample media types from the SRS demonstration and provided a quality control data package with their analysis results. These results and a discussion of the analytical data are presented below.

Two out-of-limit conditions were identified in the quality control data package sent along with the analysis results. Eight water samples were flagged as missing the maximum holding time by one day. This occurrence was judged not to have significant impact on data quality. Also, 10 of 13 soil gas sample analyses were reported as estimated values since they were outside the calibration range for the species of interest. These reported values were judged to be of unacceptable data quality as further discussed below.

---

<sup>6</sup> Good internal lab quality control indicates that a complete QC package was received with the sample analysis data and that the QC data were within method or laboratory guidelines.

<sup>7</sup> Satisfactory internal lab quality control indicates that an incomplete QC package was received with the sample analysis data but that the available QC data were within method or laboratory guidelines.

### ***GEL Internal Quality Control Data***

The quality control data package revealed that the GEL GC/MS passed daily calibration and internal blank checks during analysis of SRS samples. Surrogate chemical spikes were used for all seven soil samples analyzed and recoveries were within the 80-120% range prescribed by Method 8260. Internal laboratory duplicates of soil and water spikes gave RPD values that were less than 20%. Overall, the internal quality control data reveal good laboratory procedures and results.

### ***GEL Accuracy Data***

The accuracy results for GEL are presented in Table 5-2 and derived from the analysis of spike and PE water samples containing TCE and PCE. EPA Method 8260 calls for empirical derivation of acceptable compound recovery ranges by each lab as they routinely conduct analyses.

**Table 5-2. GEL Laboratory Accuracy Data.**

Sample Media/Description	Reference Concentration ( $\mu\text{g/L}$ )		Percent Recovery	
	PCE	TCE	PCE	TCE
Water Low Spike	2.7	2.6	116	220
Water Medium Spike	40.4	38.3	106	210
Water High Spike	270	256	130	276
Water PE Sample 1	NP	NP	-	-
Water PE Sample 2	19.8	46	127	128

Notes: NP = Not present

The GEL water analyses results reveal percent recoveries for PCE for all samples within the acceptable range of 64-148% as provided in GEL's implementation of Method 8260 in their QA plan. However, the spike recoveries for TCE in water are in excess of 200%. Recovery limits for TCE, stated in GEL's implementation of Method 8260, are 71-157%. On the other hand, the TCE recovery values for PE Sample No. 2 is within prescribed limits. The result for the PE sample is given precedence over the results from the spike samples since the water spikes were prepared in the field by SRS laboratory personnel and their reference values were not independently certified.

As noted previously in Section 4, problems were encountered in soil spike preparation at the SRS demonstration and the overall quality of the spikes was judged to be unacceptable as reference material.

No accuracy determinations were made for the soil gas samples because all the analytical values reported by GEL were estimates.

**Table 5-3. GEL Laboratory Precision Data.**

Sample Media/Description	Reference Concentration ( $\mu\text{g/L}$ )		Relative Percent Difference	
	PCE	TCE	PCE	TCE
Water Low	10	60	3	22
Water Medium	150	160	2	5
Water High	12,200	6,000	5	2

### ***GEL Precision Data***

The precision analysis results for GEL are presented in Table 5-3 and are based on the results of duplicate sample analyses.

Precision results for the water duplicate samples show good precision for both PCE and TCE for all three samples. Precision results for the soil gas duplicate samples could not be evaluated since all the reported values were estimated.

### **GEL Data Quality Summary**

The soil gas analysis results from GEL indicate that this data set is unsuitable for comparison with the field technology results. The soil gas analyses are unacceptable because the sample analysis values were estimated values only and cannot be used for comparisons with the field technologies. The precision data for the water analyses were judged to be good. The accuracy data for the water analyses were also good if the recovery data for the TCE spike samples are discounted. The general data quality for the GEL water analyses was considered good and suitable for comparison with the different technologies.

### **SRS On-Site Laboratory Data Quality Evaluation**

As noted previously, the SRS Laboratory analyzed soil, water, and soil gas samples during the SRS demonstration; however, their data were not originally intended for reference use. Because of the semi-quantitative nature of the GEL soil gas data, the SRS on-site soil gas data were evaluated as a possible replacement. A post-demonstration evaluation of their soil gas data and accompanying quality control data was carried out in the hope that the SRS laboratory data were of sufficient quality for comparison with field technology results.

#### ***SRS Internal Quality Control Data***

The SRS Laboratory Hewlett-Packard Model 5890 gas chromatograph, equipped with dual flame ionization and electron capture detectors, was calibrated daily and internal blank checks showed acceptable performance in terms of detection levels and instrument contamination. The SRS Laboratory also provided a record of calibrations performed on their system for seven chlorinated compounds. These data give an indication of the day-to-day variability of the GC system. Multiple analyses of standard solutions gave relative standard deviations in the range of 2 to 11% for high (1,000 ppm) vapor concentrations; in the range of 5 to 9% for medium (100 ppm) concentrations, and in the range of 6 to 11% for low (10 ppm) concentrations. These data indicate that the SRS GC system meets the 30% precision criteria, indicating good overall quality control procedures and instrument performance.

#### ***SRS Accuracy Data***

The accuracy data for the SRS Laboratory soil gas analyses are summarized in Table 5-4. The results are based on the laboratory analyses of TCE and PCE spike and PE samples.

**Table 5-4. SRS Laboratory Accuracy Data.**

Sample Media/Description	Reference Concentration (ppm)		Percent Recovery	
	PCE	TCE	PCE	TCE
Soil Gas Low Spike	1.18	1.34	56	78
Soil Gas Medium Spike	118	134	76	77
Soil Gas High Spike	1,182	1,340	99	91
Soil Gas PE Sample 1	1	1.1	61	91
Soil Gas PE Sample 2	93	98	94	95

Accuracy results for the SRS Laboratory soil gas sample analyses show that of the ten analyses conducted, all but two fall within the accepted limits of 75-125% specified in method TO-14, while all of the results are within  $\pm 50\%$ . Low recovery results are observed for the spike samples nearer the 10 ppm instrument PQL. The SRS Laboratory GC-flame ionization detector data were used for this evaluation since this

system was best suited for analysis of the medium and high level spike and PE sample concentrations. Although the recoveries for these samples are consistently low, they generally indicate satisfactory performance for both PCE and TCE over this wide concentration range.

***SRS Precision Data***

The soil gas precision data for the SRS Laboratory are presented in Table 5-5. The precision analysis of the soil gas data shows RPD values less than 30% for PCE and TCE at all three concentration levels. This indicates that the performance of the laboratory was good and these data can be used in the verification.

**Table 5-5. SRS Laboratory Precision Data.**

Sample Media/Description	Reference Concentration (ppm)		Relative Percent Difference	
	PCE	TCE	PCE	TCE
Soil Gas Low	1	0.1	8	<1
Soil Gas Medium	80	100	3	3
Soil Gas High	250	500	1	3

**SRS Laboratory Data Quality Summary**

The accuracy and precision results for the soil gas samples consistently fall within 30% of the reference values. Overall, the soil gas analyses results reveal satisfactory data quality, and a suitable replacement for the GEL soil gas data.

***Laboratory Data Validation for the WAFB Demonstration***

At least 15 VOC contaminants are known to exist at the WAFB demonstration site. Typical concentration levels of these major contaminants in soil, water, and gas media were provided to the developers in the demonstration plan [SNL, 1995]. As stated in Section 4, the contaminants at the WAFB site include BTEX, chlorinated hydrocarbons, and other organics. High background levels of petroleum hydrocarbons (jet fuel) are encountered as well. Based on the information in the demonstration plan and the pre-demonstration activities, each developer chose at least ten of the identified contaminants for analysis. Not all the target contaminants were detected in all of the samples collected and not all of the developers chose to analyze the same contaminants. Therefore, the data quality evaluation of the analytical laboratories participating in the WAFB demonstration were based on the analytical results from five compounds that were analyzed by each of the laboratories and the field technologies. The compounds used for evaluation were benzene, toluene, total xylenes, PCE, and TCE. In a few cases, dichloroethene (DCE) was also included where TCE or PCE were not detected.

**Traverse Data Quality Evaluation**

The laboratory QA/QC plan had been audited by Sandia prior to the demonstration. Laboratory operations were found to be in accordance with good laboratory practice guidelines and the requirements stated in the various standard methods used in the analysis of samples.

Traverse Analytical Laboratory analyzed soil and water samples from the WAFB demonstration and provided Sandia with complete analysis results and accompanying quality control data package. A complete description of the analytical methods used in the analysis was also included in the quality control package. No out-of-limit quality control conditions were reported in the data package. The internal quality control results and a discussion of the analytical data with respect to accuracy and precision are presented below.

***Traverse Internal Quality Control Data***

Daily quality control results for the GC/MS instrument used for the sample analyses included mass spectrometer tuning, blank checks, and initial and continuing calibration checks. The quality control results reveal good instrument performance throughout the course of the WAFB demonstration sample analyses. Surrogate chemical spikes were also used for all seven soil samples analyzed and surrogate chemical recoveries were within the 80-120% that is considered acceptable according to Method 8260. Internal laboratory duplicates of selected soil and water spike samples also met the RPD criteria of less than 20%. Overall, the internal quality control results indicate good quality control and instrument performance during the analyses.

**Traverse Accuracy Data**

The accuracy data for Traverse are presented in Table 5-6 and are based on the results of spike recoveries and PE sample recoveries of the five target analytes for the soil and water media analyzed. Table 5-7 provides the reference concentration levels for each of these analytes.

**Table 5-6. Traverse Laboratory Accuracy Data.**

Sample Media/ Description	Percent Recovery				
	Benzene	Toluene	Xylenes	PCE	TCE
Soil PE No. 1	89	98	87	154	85
Soil PE No. 2	66	71	65	102	62
Water Low Spike	97	95	112	105	120
Water Medium Spike	119	93	106	96	84
Water High Spike	76	79	81	75	70
Water PE Sample 1	78	NA	101	NA	NA
Water PE Sample 2	81	89	101	76	85

Note: NA = not analyzed; analyte not present in sample

The percent recoveries for eight out of ten soil analyses fall within accepted recovery levels of 65-135%, as given in the Traverse QA documentation. On the basis of these results, overall laboratory accuracy performance is judged to be good. Likewise, the percent recoveries for the water analyses reveal recoveries for the five target analytes, over a wide range of concentrations, well within the laboratory's acceptance limits for all 22 analyses.

**Table 5-7. WAFB Water and Soil PE/Spike Sample Reference Concentrations.**

Sample Media/ Description	Reference Concentrations				
	Benzene	Toluene	Xylenes	PCE	TCE
Soil PE No. 1 ( $\mu\text{g}/\text{kg}$ )	61,000	55,000	76,000	91,000	7,900
Soil PE No. 2 ( $\mu\text{g}/\text{kg}$ )	64,000	59,000	81,000	98,000	8,600
Water Low Spike ( $\mu\text{g}/\text{L}$ )	59	45	190	63	27
Water Medium Spike ( $\mu\text{g}/\text{L}$ )	1,180	904	3,790	1,256	715
Water High Spike ( $\mu\text{g}/\text{L}$ )	66,140	50,620	212,300	70,340	40,040
Water PE Sample 1 ( $\mu\text{g}/\text{L}$ )	66	NP	158	NP	NP
Water PE Sample 2 ( $\mu\text{g}/\text{L}$ )	20	20	50	20	46

Note: NP = Not present

**Traverse Precision Data**

The precision data for Traverse are presented in Table 5-8 and are based on the results of duplicate and in some cases triplicate analysis of the analytes in the two media. Table 5-9 shows the reference concentration levels for each of the target analytes evaluated.

**Table 5-8. Traverse Laboratory Precision Data.**

Sample Media/ Description	Relative Percent Difference				
	Benzene	Toluene	Xylenes	PCE	TCE
Soil PE No. 1	16	8	6	7	6
Soil PE No. 2	<1	9	8	9	8
Soil Low	*	*	*	*	*
Soil Medium	*	*	122	*	*
Soil High	*	13	14	*	*
Water Low	<1	*	<1	<1	*
Water Medium	7	11	8	*	*
Water High	9	*	22	*	*

Note: \* = No evaluation as a result of non-detectable levels in one or more samples

**Table 5-9. WAFB Water and Soil Duplicate Sample Concentrations.**

Sample Media/ Description	Reference Concentrations				
	Benzene	Toluene	Xylenes	PCE	TCE
Soil PE Sample No. 1 ( $\mu\text{g}/\text{kg}$ )	61,000	55,000	76,000	91,000	7,900
Soil PE Sample No. 2 ( $\mu\text{g}/\text{kg}$ )	64,000	59,000	81,000	98,000	8,600
Soil Low ( $\mu\text{g}/\text{kg}$ )	ND	ND	ND	ND	ND
Soil Medium ( $\mu\text{g}/\text{kg}$ )	ND	ND	5,000	ND	ND
Soil High ( $\mu\text{g}/\text{kg}$ )	ND	600	55,000	ND	ND
Water Low ( $\mu\text{g}/\text{L}$ )	2	ND	20	2	ND
Water Medium ( $\mu\text{g}/\text{L}$ )	40	35	385	ND	ND
Water High ( $\mu\text{g}/\text{L}$ )	20	2	50	ND	ND

Note: ND = Not detected

A number of non-detects were reported for the five target analytes in the soil duplicate samples. Since the soil samples were prepared in triplicate, the RPD values shown are an average of the two or three RPD values. For the available data, except for one high xylene RPD value, the RPD results for the soil analyses are less than 30%.

Low RPD values were observed for the eight water samples that could be evaluated. Unfortunately, most of the samples had non-detectable levels of TCE and PCE and could not be evaluated in terms of precision. Overall, the observed precision for the water samples, where precision determinations were possible, was less than 30% and judged to be good.

### Traverse Laboratory Data Quality Summary

The Traverse internal quality control results revealed good laboratory procedures and instrument performance. Accuracy and precision data for the water samples are consistently at values of 30% or less. On the basis of these considerations, the Traverse water data set was judged to be of good quality and suitable for use as reference data. Likewise, the soil accuracy and precision analysis data also are consistently (with one exception concerning the precision of a xylene analysis) within 30% of the reference values; however, evaluations were carried out only at relatively high (>1 mg/kg) compound concentration levels. These data are judged to be of good quality and suitable for reference use, with the caution that soil matrix precision and accuracy are not determined at lower concentrations ranges.



## Pace Data Quality Evaluation

The Pace QA plan was audited by Sandia personnel prior to the demonstration. Laboratory operations were found to be in accordance with good laboratory practice guidelines and the requirements stated in EPA Method TO-14.

As noted earlier, Pace analyzed soil gas samples from the WAFB demonstration and provided analysis results and a quality control data package. The results and a discussion of the analytical data are provided below. No out-of-limit quality control conditions were reported in the analysis results data package. As with Traverse, the assessment of precision and accuracy of the analytical laboratory are considered using the data from the five target compounds. Because the results for the soil gas analyses for both PCE and TCE generally showed non-detects, another chlorinated solvent that was detected in the analysis, DCE, was included in the soil gas accuracy and precision analyses.

### *Pace Internal Quality Control Data*

Blank soil gas samples were analyzed in the laboratory and the results were in accordance with performance specified in the TO-14 method. Spiked vapor samples were also run on two different days. Calibration check recoveries for the five target compounds ranged from a low of 94% to a high of 110%, all within the 75-125% acceptance criteria called for in Method TO-14. The quality control data provided in the analysis report indicated good instrument performance.

### *Pace Accuracy Data*

The accuracy data for Pace analysis of Summa™ canisters are presented in Table 5-10 and are based on the results of spike recoveries of the target analytes. Table 5-11 provides the associated reference concentration values for the compounds evaluated. Data from Tedlar bag samples are not included in the analyses since the TO-14 method requires the use of passivated steel canisters for better sample stability and recovery.

**Table 5-10. Pace Laboratory Accuracy Data.**

Sample Media/ Description	Percent Recovery					
	Benzene	Toluene	Xylenes	PCE	TCE	DCE
Soil Gas Low Spike <sup>1</sup>	112	96	88	107	61	95
Soil Gas Medium Spike	93	NA	82	NA	48	65
Soil Gas High Spike	44	NA	43	NA	20	32

Note: <sup>1</sup> - recovery values shown corrected by a factor of ten, see text for discussion.

NA = Not analyzed, contaminants not present in spike mixture

**Table 5-11. WAFB Soil Gas PE/Spike Sample Reference Concentrations.**

Sample Media/ Description	Reference Concentrations in ppm					
	Benzene	Toluene	Xylene	PCE	TCE	DCE
Soil Gas Low Spike <sup>1</sup>	3	2	8	1	1	2
Soil Gas Medium Spike	50	NA	73	NA	50	58
Soil Gas High Spike	250	NA	364	NA	250	291

Note: <sup>1</sup> - reference values shown corrected by factor of 10, see text for further discussion

NA = Not applicable; analyte not present in spike mixture

Initial evaluation of the low spike sample recoveries yielded values in the range of 1,000% and were suggestive of a factor of ten error. A calculation error in computation of the reference values was suspected; however, a definite error was not found. Some uncertainty exists, as recorded in laboratory notebooks, as to whether the air volume into which the spike was injected was 1 or 10 liters. A review of

the data from each of the field participants showed a similar very high recovery trend, giving further support for the factor of ten error. In view of these combined results, the low spike reference value was increased by a factor of ten as shown in Table 5-11 with resultant changes in Table 5-10. Compound recovery for Pace is marginal with satisfactory recovery at the low and medium ranges and poor recovery at higher concentration ranges. Recovery is also generally better for non-chlorinated compounds than for chlorinated compounds.

The soil gas spikes were transferred from bags to canisters prior to shipment to the Pace. These transfers, as well as dilution required for the high spike sample analysis, may have caused significant changes in the sample composition. Previous WAFB soil gas survey results presented in Table 4-3 show that the concentration ranges of interest at this demonstration site are generally less than 100 ppm for most VOC compounds. As noted in Table 5-10, recovery data for Pace at contaminant concentration levels less than 100 ppm are generally good. Since the field sample concentration levels are reasonably well matched to the concentration levels at which Pace performance is satisfactory, the laboratory results are considered suitable as reference data for soil gas contaminant concentrations less than 100 ppm.

***Pace Precision Data***

The soil gas samples used for this analysis were taken sequentially over approximately a two minute period from the monitoring well at each of the three levels selected for sampling. As stated previously, these sequential samples may not be true duplicate samples. As with the other field duplicates taken sequentially from monitoring wells during this demonstration, an assumption is made for the purposes of the precision evaluation that the sequential samples are equivalent. Calculation of RPD values based on these samples then gives an upper limit of the laboratory instrument RPD since some portion of the RPD could be attributable to sample differences. Precision determinations, based on these assumptions for the Pace soil gas analyses, are given in Table 5-12, while Table 5-13 provides the reference concentration levels for the soil gas samples.

The precision data in Table 5-12 show that 8 of 11 RPD values fall within the 30% margin. Nine of the 11 RPD values fall within the 0-50% range. On the basis of these data, Pace precision performance is judged to be satisfactory.

**Table 5-12. Pace Laboratory Precision Data.**

Sample Media/Description	Relative Percent Difference					
	Benzene	Toluene	Xylenes	PCE	TCE	DCE
Soil Gas Low	76	NA	66	NA	NA	47
Soil Gas Medium	9	22	5	NA	NA	9
Soil Gas High	3	12	7	NA	NA	7

Note: NA = Not analyzed, contaminant not detected in one or both samples

**Table 5-13. WAFB Soil Gas Duplicate Sample Concentrations.**

Sample Media/Description	Reference Concentrations in ppm					
	Benzene	Toluene	Xylenes	PCE	TCE	DCE
Soil Gas Low	2	0.1	20	ND	ND	8
Soil Gas Medium	7	0.5	30	ND	ND	10
Soil Gas High	9	1	50	ND	ND	13

Note: ND = Not detected

### **Pace Data Quality Summary**

Based on the accuracy and precision results and the concentration ranges shown in Tables 5-11 and 5-13, the Pace soil gas analysis data quality can be regarded as satisfactory for soil gas contaminant concentration ranges between 1 and 100 ppm and are suitable for comparison with the various technologies only within this range.

### ***Summary Description of Laboratory Data Quality***

The data quality from each of the laboratory analyses was systematically evaluated for each of the three sampling media selected for study in this demonstration. The results of these evaluations have been previously discussed in detail and are summarized in Table 5-14 for the SRS demonstration and Table 5-15 for the WAFB demonstration. Because of the number of laboratories, evaluation criteria, and media, as previously discussed, an overall data quality grade of *good*, *satisfactory*, or *unacceptable* has been assigned to each of the reference laboratory data sets. Data sets falling into the good or satisfactory categories are considered suitable for comparison with field technologies. An unacceptable data quality ranking indicates that these data are unsuitable for use as reference data.

For SRS, each sample media type except soil was determined to have a good reference data set. The data quality for the WAFB demonstration was determined to have a satisfactory or better reference data set for comparison to field analytical results.

**Table 5-14. SRS Demonstration Laboratory Data Quality Ranking.**

Sample Media	Laboratory	
	GEL	SRS
Soil	No Determination	No Determination
Water	Good	No Determination
Soil Gas	Unacceptable	Satisfactory

**Table 5-15. WAFB Demonstration Laboratory Data Quality Ranking.**

Sample Media	Laboratory	
	Traverse	Pace
Soil	Good	No Determination
Water	Good	No Determination
Soil Gas	No Determination	Satisfactory

## Section 6

### Technology Demonstration Results and Evaluation

#### *Introduction*

Analytical results and an evaluation of the Viking SpectraTrak™ 672 GC/MS data collected during the SRS and WAFB demonstrations are presented in this section. The demonstrations provided an opportunity for analysis of soil, water, and soil gas media by the Viking GC/MS system. Data from the Viking system are compared to the previously discussed reference laboratory data. Following presentation of the Viking sample analysis data, instrument performance is assessed using a number of performance goals also described in this section.

#### *Pre-Demonstration Developer Claims*

Before the actual field demonstration, the Consortium requested instrument performance claims from the Viking Instruments Corporation. The performance claims provided by Viking were, to a limited extent, discussed with the Consortium; however, they were not significantly altered prior to their inclusion in the demonstration plan. Since this was a pilot demonstration, the various proposed methodologies for field instrument comparison with reference laboratories were largely unproved. Consequently, the claims made by the developer, although loosely defined at the outset, were accepted with the expectation that specific performance evaluation goals would be developed as experience was gained carrying out the demonstration and the subsequent data analysis. The initial claims made by Viking for the GC/MS system taken from the demonstration plan prepared prior to the field demonstrations [SNL, 1995] are as follows:

- **Accuracy:** Instrument data within  $\pm 30\%$  of reference laboratory values.
- **Precision:** Instrument relative percent differences less than or equal to 25%.
- **Completeness:** For all samples analyzed, 95% of target VOC compounds detected by reference laboratory also detected by the instrument.
- **Sample throughput:** (Dependent upon analysis methodology.) Samples requiring pre-concentration: 30 minutes per sample; Direct injection: 10 to 15 minutes per sample. Sample input via membrane inlet: 20 to 30 seconds per sample.
- **Methodology:** EPA Method 8260, a fixed-laboratory procedure.
- **Calibration Stability:** Instrument multi-point calibration completed before arriving at the demonstration site. Daily one-point calibration checks during demonstration.
- **Reported Data:** Quantitative results submitted at the end of each day of the demonstration.
- **Deployment:** Instrument can be set up and ready for sample runs within 30 minutes.

The performance claims stated above address the critical areas of instrument performance and provide a framework to evaluate the capabilities and utility of the technology. However, the claims as stated do not take such issues as statistical variation in the reference laboratory and the field technology data into consideration. An evaluation based solely on these claims may not fairly evaluate technology performance. For example, the following questions illustrate problems that can arise when considering the above claims:

- Is the instrument accuracy or precision claim considered met if one or two outliers or extreme values do not meet the claim?

- Should reference laboratory data be used for comparison with technology data if significant inaccuracies are encountered in the reference laboratory data?

As a result of these considerations, the original developer claims were used as a basis in formulating more specific performance goals such that instrument performance could be more fairly evaluated. The performance goals incorporated a consideration of the statistical characteristics of the reference laboratory and technology measurements, rather than simply evaluating individual measurements. This approach serves to decrease the effect of an occasional outlier data point on the overall evaluation of the technology or the reference laboratory. The rationale and approach used in setting the performance goals for each of the identified criteria, such as accuracy and precision, generally follows that stated in EPA Method 8260 for water and soil analyses and EPA Method TO-14 for soil gas analyses. The development of these performance goals and evaluation criteria are further discussed in the following sections.

### ***Field Demonstration Data Evaluation Approach***

A discussion of the methodology and its underlying rationale used for Viking instrument performance assessment is given in the following paragraphs. The methodology is based on instrument performance in three specific areas: precision, accuracy, and comparability of Viking data to reference laboratory data. The evaluation methodology uses instrument performance claims made by Viking as a starting point in the formulation of specific instrument performance goals.

One of the limitations encountered in this particular study is the existence of a limited number of data points for each target analyte in the sample media. For example, analysis of water samples for dichlorobenzene at the Wurtsmith demonstration by Viking and the reference laboratory produced only five sample pairs that could be compared. A small sample size of five pairs significantly limits the ability to draw conclusions about the performance of the Viking instrument for this particular compound. One method of dealing with small sample sizes and their associated uncertainties is to pool the data for all analytes in a particular sampling medium and apply statistical techniques to the pooled data set in order to gain an understanding of the overall performance of the GC/MS system. Many of the factors contributing to measurement uncertainty are random and thus tend to average out when many analysis results are considered together. However, in pooling the data, the assumption must be made that the GC/MS responds to the various target compounds in a similar fashion. As an example, the instrument accuracy and precision for benzene is not assumed to be significantly different than its accuracy and precision for trichloroethene. This is a reasonable assumption for the compounds under investigation in this study. All of the target compounds were either aliphatic or aromatic compounds with a subset of these being chlorinated species with similar chromatographic and detection properties. Compounds with significantly different chromatographic properties, such as alcohols, ethers, ketones, etc., which have different GC/MS response characteristics, were not included in the target analyte list.

### **Instrument Precision Evaluation**

The precision of the field instrument is evaluated by computing the relative percent difference of duplicate sample results. The definition for *relative percent difference* (RPD) is as follows:

$$RPD = \frac{|x_1 - x_2|}{\bar{x}} \cdot 100$$

where  $x_1$  and  $x_2$  are duplicate measurements and  $\bar{x}$  is the average of the two measurements. Precision provides a measure of the stability of the instrument under actual field operations and is one of the key indicators of instrument performance. The precision claim, made by Viking prior to the start of the demonstrations, was RPD values of 25% or less. Refinement of these initial claims into specific performance goals was done following the demonstration in order to incorporate statistical

considerations of the data. For example, allowance is given for occasional Viking RPD values that fall outside the 0-25% range. The Viking RPD data are pooled by sampling media and a determination is made as to whether the median value of the distribution falls in the 0-25% range. This first precision performance criterion is consistent with that specified in Methods 8260<sup>8</sup> and TO-14. If this first test criteria is not met, a second evaluation is done. In the second test, the determination is made as to whether the median Viking RPD value is less than or equal to 95th percentile of RPD values similarly pooled from the reference laboratory data. The underlying rationale is that Viking precision is adequate if it is comparable to that observed in the reference laboratory data in this demonstration. Thus, if either precision criteria are met, Viking precision performance is judged acceptable.

### **Instrument Accuracy Evaluation**

Instrument data accuracy is evaluated by comparing the Viking GC/MS analysis results from PE and spike samples with known VOC contaminant levels. The spike samples were prepared in the field in soil, water, and soil gas media from pure compounds or known mixtures. Performance evaluation samples, on the other hand, were purchased or obtained from independent vendors and had undergone extensive analysis by multiple laboratories. They were accompanied by a certificate of analysis in which the concentration levels of the sample components were specified. Often an uncertainty or confidence interval, based upon the multiple laboratory results, was also provided. One way of expressing instrument accuracy, relative to the reference concentration of the PE or spike sample, is by the use of the term *percent recovery* (REC), as described below:

$$REC = \frac{x_{instrument}}{x_{reference}} \cdot 100$$

where  $x_{instrument}$  is the measured concentration by a field instrument and  $x_{reference}$  is the true concentration. For example, if the benzene content in a PE sample was 100 ppm and the field instrument analytical result was 110 ppm, the percent recovery would be 110%. The *absolute percent accuracy* (APA), also used in these evaluations, is defined as follows:

$$APA = |REC - 100|$$

Acceptable limits of recovery are empirically derived by a particular laboratory during routine use of Methods 8260 and TO-14. Consequently, they vary somewhat among laboratories and compounds. However, recovery values falling within the range of 70 - 130% are considered acceptable in terms of instrument and method quality control [EPA, 1987]. Recoveries that fall outside this range may still be acceptable for some compounds and must be evaluated on an individual compound and laboratory basis.

Initial Viking claims regarding accuracy were made only in the context of reference laboratory data. Strictly speaking, accuracy assessments should only be made against samples for which a true or certified value is available. Reference laboratory results do not necessarily represent the true VOC contaminant content of the samples. Viking accuracy performance goals are stated in the context of Viking and reference laboratory analytical results on PE and spike samples for which reference values were available. They are much like those developed for precision assessment, in the sense that they also include statistical considerations. The absolute percent accuracy values for Viking are pooled by

---

<sup>8</sup> Paragraph 8.5.5 of Method 8260 states in part: "Results are comparable if the calculated percent relative standard deviation (RSD) does not exceed 2.6 times the single laboratory RSD or 20% whichever is greater and the mean recovery lies within the interval  $R \pm 3S$  or  $R \pm 30\%$ , whichever is greater."

sampling medium. A determination is made as to whether the median APA value falls within the 0-30% range. A second evaluation is done if the first criterion is not met. In this test, a determination is made as to whether the median Viking APA value is less than or equal to 95th percentile of APA values pooled from the reference laboratory data. As with the precision assessment, the understanding is that Viking accuracy should be judged acceptable as long as it is comparable to that observed in the reference laboratory data in this demonstration. Thus, if either criteria are met, Viking accuracy performance is judged acceptable.

### **Instrument Comparison with Reference Laboratory Data**

A third approach for evaluation of Viking GC/MS instrument performance entails a comparison of Viking results with reference laboratory results for paired sample analyses. As described in Section 5, the reference laboratory data were ranked *good*, *satisfactory* and *unacceptable* in terms of overall quality. Only those laboratory results that were ranked good or satisfactory are used for comparison with the field instrument data.

To varying degrees, reference laboratory analytical results possess inaccuracies and uncertainties--a fact which complicates comparisons between laboratory and field instrument data. Uncertainties in analytical results are influenced by factors such as sample transport and storage, improper instrument calibration, operator technique, and instrument noise, to name a few. Even in cases where sample transportation and storage operations are performed correctly, the sample that reaches the analytical instrument may be different in chemical composition from that analyzed by the field instrument as a result of heterogeneities in the sample matrix, chemical reaction, evaporative losses, microbial degradation, and others.

The Viking to laboratory comparison takes these uncertainties into account by computing the percent difference between the Viking and reference laboratory results for each duplicate sample pair and examining the distribution of these percent differences for each sample media relative to an absolute accuracy standard--in this case  $\pm 50\%$ . The *percent difference* (DIF) for each sample pair is mathematically expressed as follows:

$$DIF = \frac{[x_{instrument} - x_{lab}]}{x_{lab}} \cdot 100$$

where  $x_{instrument}$  is the measured concentration by a field instrument and  $x_{lab}$  is the measured concentration of the same sample by the reference laboratory. A related term, the absolute percent difference, ignores the sign of the percent difference value. For this demonstration, the absolute percent difference criterion was set at 50%. Methods 8260 and TO-14 typically call out  $\pm 30\%$  as a tolerable range for percent differences of an instrument relative to a PE or spike reference value; however, the reference value (the laboratory result) also has inherent inaccuracy. Consequently the  $\pm 30\%$  margin is widened to  $\pm 50\%$  to account for this variability. The Viking to laboratory comparison performance goal stipulates that the median absolute percent difference for each sampling media should be in the range of 0-50%. Failure to meet this goal suggests that a significant difference between the Viking system and the laboratory may exist. As part of the instrument to laboratory comparison, an additional bias significance test is performed as described more fully below.

Where a large bias is suspected between the field method and reference laboratory, a statistical technique known as the Wilcoxon Matched Pair test was used to assess the differences encountered between field technology and laboratory data. Both laboratory and field method data include measurement uncertainty as a result of random variability encountered in the sample collection, distribution, and analysis process. A statistical comparison was carried out to determine whether the range of differences encountered



between the two methods could be explained by random variability or, alternatively, whether a significant or true bias exists between the two methods. The Wilcoxon Matched Pairs test is a non-parametric test, meaning that no assumptions are made concerning the distribution of the population from which the field instrument and reference laboratory samples are drawn [Iman, 1994; Conover, 1980]. The test produces a test statistic which can be interpreted as the ratio of *observed differences* in the two data sets to expected *random differences* in the same two data sets. Thus, in very general terms, a large test statistic indicates a significant difference between two instruments or methods. The Wilcoxon test statistic is influenced to a greater extent by the larger values in the data sets being compared, particularly when the data span many orders of magnitude such as encountered in this study. In order to eliminate this undesired effect, the data pairs were normalized by using the percent difference determination for each sample pair, as described earlier. The percent difference computed for each Viking measurement relative to the paired sample laboratory value is compared against a reference percent difference value of zero in the statistical test.

The quantitative aspect of the Wilcoxon test is given by the p-value, or probability, associated with a computed test statistic. For example, a test result with a p-value of 0.05 indicates that the probability of two equivalent techniques producing the observed differences as a result of random variability alone would be 0.05. By convention, a p-value of 0.05 is often used as the decision point as to whether a statistically significant bias exists between the two sets of measurements. A p-value less than 0.05 indicates differences between two methods that cannot be explained by random variation alone. On the other hand, p-values greater than 0.05, indicate that observed differences between two methods can be explained by random variation between equivalent methods.

The outcome of the Wilcoxon test is used to make a final decision as to whether one is justified in calling the Viking field measurements comparable or not comparable to reference laboratory measurement. A Wilcoxon test result with a p-value less than 0.05 indicates that Viking data are not comparable to reference laboratory data for a particular sampling medium.

In summary then, two criteria are used for assessing Viking to laboratory accuracy. First a determination is made as to whether the median absolute percent difference is in the range of 0-50%. If this criteria is not met, the Wilcoxon test is performed on the data set to test the significance of the observed bias. If the test result indicates significance, the overall Viking to laboratory comparison goal is judged not met. Alternatively, if the test indicates no significance, the goal is judged to have been met.

### ***Scatter Plots***

Another way to evaluate the performance of the Viking GC/MS with respect to the reference laboratory is through the use of scatter plots. The plots are prepared in log-log format since the concentrations generally spanned many orders of magnitude. Two solid lines are positioned on each graph which mark the  $\pm 50\%$  difference about the zero bias line. As noted in earlier discussion, the  $\pm 50\%$  margins are chosen as an indicator of acceptable instrument performance relative to reference laboratory data. The value is derived as follows: If the assumption is made that the uncertainty on field technology and laboratory measurements is  $\pm 20\%$ , then a worst case percent difference between two measurements at either extremes of the  $\pm 20\%$  range would be  $\pm 50\%$ . As an example, consider a sample with a true concentration of a target analyte of 100 mg/L. The field method reports a value 20% high at 120 mg/L and the laboratory reports the value 20% low at 80 mg/L. The percent difference between these two values is 50%. Thus the  $\pm 50\%$  bias line denotes acceptable tolerances on field instrument comparisons to reference laboratory data.

In some cases where the data span five or more orders of magnitude, two plots are used. The plots provide the reader an indication of instrument bias and correlation<sup>9</sup> relative to reference laboratory data. Here, bias is defined as a systematic difference of one method relative to another across a portion of or the entire measurement range of the instrument. Bias is directly related to accuracy. A method with low bias is one with high accuracy. A method with a -10% bias is accurate to within 10%. As an example, Figure 6-1 shows four sets of simulated data with various amounts of bias and random “noise” added. The zero bias line, not shown in the plots, extends from the lower left to the upper right corners of each plot. These findings are based on the assumption that any bias is a constant fraction of the actual value of the result, and that instrument performance is linear over a range spanning several orders of magnitude.

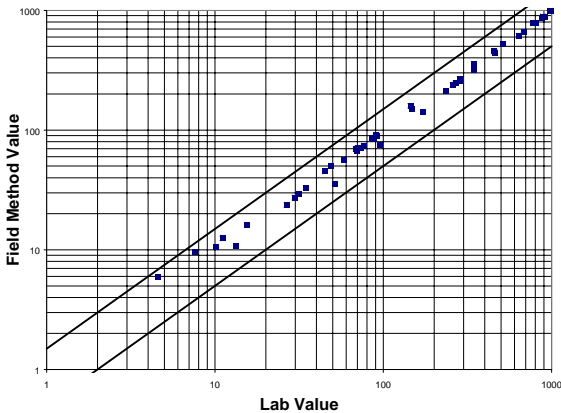

(a) High correlation; low bias

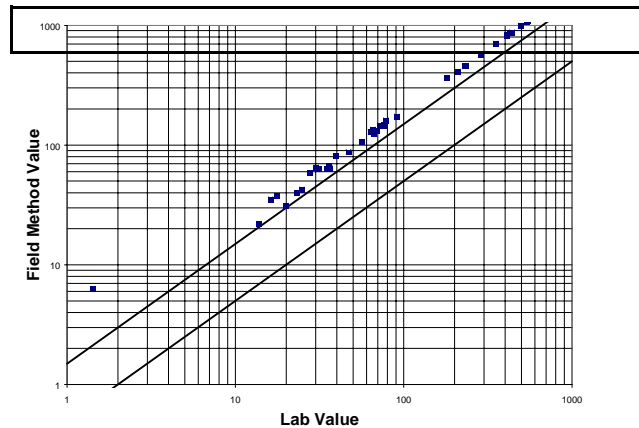

(b) High correlation; positive bias

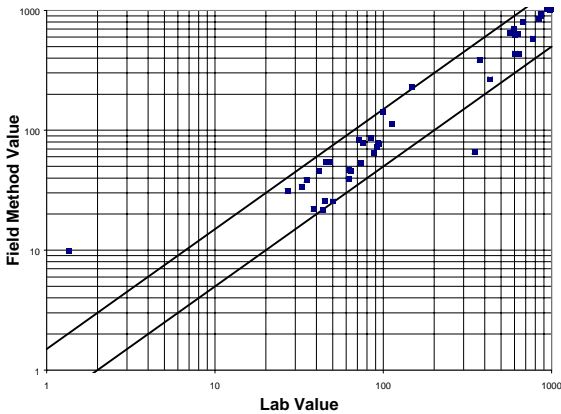

(c) Low correlation; low bias

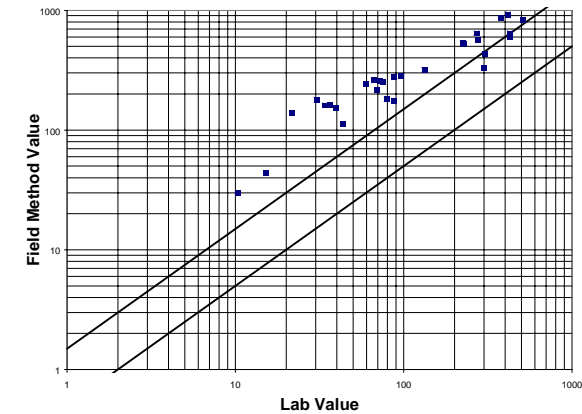

(d) Low correlation; positive bias

**Figure 6-1.** Example scatter plots with simulated data. The four plots illustrate various degrees of measurement correlation and method bias or accuracy. The reference laboratory value is plotted on the x-axis and the paired field technology value on the y-axis. The solid lines mark the  $\pm 50\%$  interval about the zero bias line.

<sup>9</sup> Correlation is a measure of the degree of linear relationship between two variables.

Data with low bias and high correlation are shown in Figure 6-1a. The data are closely clustered between the  $\pm 50\%$  lines near the zero bias line. A low bias and low correlation example is shown in Figure 6-1c. Most of the data fall within the  $\pm 50\%$  lines; however, the scatter is larger than that observed in Figure 6-1a. Positive bias is illustrated in Figures 6-1b and 6-1d for high and low correlation data, respectively. In each case, the data are grouped about a line that is shifted above the zero bias line.

### ***Histograms***

A final means to evaluate performance is accomplished by computing the percent difference between the field and laboratory value for each paired sample analysis and pooling these data across all compounds by sample medium. These percent difference computations were then tabulated into frequency histograms, examples of which are shown in Figure 6-2. The histogram gives the frequency of occurrence as a function of the percent difference interval and enables a visual evaluation of the field technology data when compared with reference laboratory data. As an example, in Figure 6-2a, nearly all the percent difference computations fall within the  $\pm 30\%$  interval, indicating good data correlation. The center of mass of the histogram falls near zero, indicating an average bias near zero. A low correlation, low bias example is shown in Figure 6-2c. In this example, 12 of the 42 total observations fall outside the  $\pm 30\%$  range. Although the overall average percent difference falls near zero, the width of the distribution reveals low data correlation. Figures 6-2a and 6-2c illustrate the same type of data shown in scatter plot format in Figures 6-1a and 6-1c, respectively. Positive bias examples with high and low correlation are illustrated in Figure 6-2b and 6-2d, respectively. In these examples, the center of mass of the histogram falls at a point other than zero, thereby revealing an overall measurement bias. Figures 6-2b and 6-2d illustrate the same type of data shown in the scatter plots in Figures 6-1b and 6-1d, respectively.

### ***Summary of Instrument Performance Goals***

The original Viking instrument performance claims, although relevant to the objectives of the demonstration, were determined to be somewhat vague following compilation and evaluation of all demonstration data. For example, should all measurements fall within  $\pm 30\%$  of reference laboratory results or should the average results for a particular sample medium meet the 30% criterion? To maintain objectivity in the process of instrument evaluation, instrument performance goals were modified and restated in such a manner that a simple yes or no answer describes whether the goals were met. A quantitative description of the performance goals, developed in the preceding paragraphs, and how data are evaluated in the context of those goals is presented below.

#### **Accuracy**

Two goals are stated. If the first goal is met, no evaluation is done relative to the second.

**Accuracy Goal 1:** Median Viking absolute percent accuracy for each sampling medium is in the range of 0-30%.

**Accuracy Goal 2:** Median Viking absolute percent accuracy for each sampling medium is less than or equal to the 95th percentile of the pooled reference laboratory absolute percent accuracies for each sampling medium.

The specific evaluation procedure is as follows:

- Pool all the Viking PE and spike sample analytical results, in terms of absolute percent accuracy, for each sample medium for which a reference value is known. Data from SRS and WAFB are combined in this analysis. All sample data are excluded whose reference values are less than  $2 \cdot \text{PQL}_{\text{Viking}}$ .

- Compile these data into a frequency histogram and compute the median  $(APA_{.5})_{\text{Viking}}$ , 80th percentile  $(APA_{.8})_{\text{Viking}}$ , and 95th percentile  $(APA_{.95})_{\text{Viking}}$  values.
- Do the same compilations for the reference laboratory data combined from both demonstration sites by sampling media.
- Apply the following assessment criteria to the absolute percent accuracy distributions:
  - (1) If  $(APA_{.5})_{\text{Viking}} \leq 30\%$ : **Accuracy Goal 1 Met** -- Viking accuracy performance is better than or equal to that specified in Methods 8260 and TO-14.
  - (2) If Viking  $(APA_{.5})_{\text{Viking}} \leq (APA_{.95})_{\text{Lab}}$ : **Accuracy Goal 2 Met** -- Viking performs comparably to conventional laboratory using accepted analytical methodologies.
  - (3) If  $(APA_{.5})_{\text{Viking}} > (APA_{.95})_{\text{Lab}}$ : **Accuracy Goal 2 Not Met** -- Viking data do not compare with the reference laboratory data.

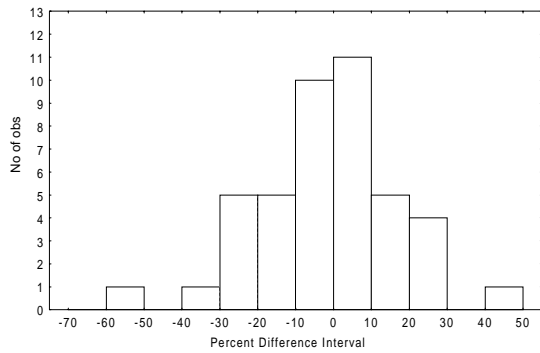

(a) High correlation; low bias

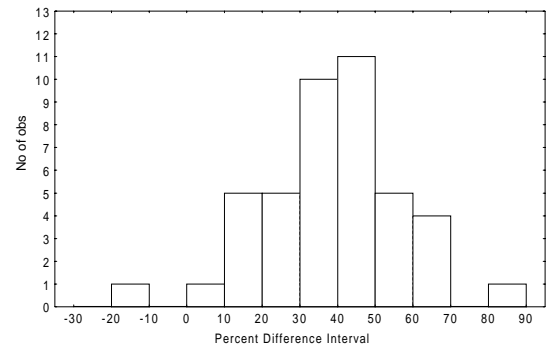

(b) High correlation; positive bias

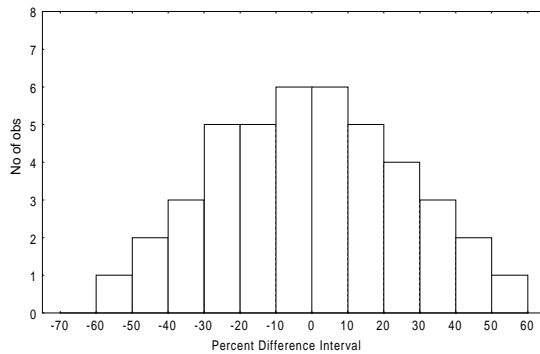

(c) Low correlation; low bias

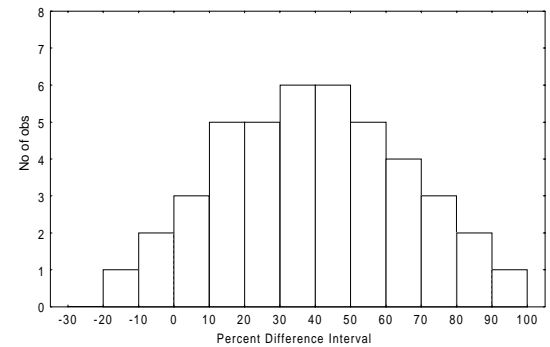

(d) Low correlation; positive bias

Figure 6-2. Example histograms with simulated data. Various combinations of measurement correlation and bias are shown.

### Precision

In a similar manner as described for accuracy evaluation, two precision goals are stated. If the first goal is met, no evaluation is done relative to the second.

**Precision Goal 1:** Median Viking relative percent difference for the pooled data from each sampling medium is in the range of 0-25%.

**Precision Goal 2:** Median Viking relative percent difference for each sampling medium is less than or equal to the 95th percentile of the pooled reference laboratory relative percent differences for each sampling medium.

The specific evaluation procedure is as follows:

- Pool all the Viking duplicate sample results, in terms of relative percent difference for each sample medium for which a reference value is known. Data from SRS and WAFB are combined in this analysis. All sample data are excluded whose reference values are less than  $2 \cdot PQL_{\text{Viking}}$ .
- Compile these data into a frequency histogram and compute the median  $(RPD_{.5})_{\text{Viking}}$ , 80th percentile  $(RPD_{.8})_{\text{Viking}}$ , and 95th percentile  $(RPD_{.95})_{\text{Viking}}$  values.
- Do the same compilations for the reference laboratory data combined from both demonstration sites by sampling media.
- Apply the following assessment criteria to the relative percent difference distributions:
  - (1) If  $(RPD_{.5})_{\text{Viking}} \leq 25\%$ : **Precision Goal 1 Met** -- Viking precision performance is within the range identified in original developer claims and is very near that specified in Methods 8260 and TO-14.
  - (2) If Viking  $(RPD_{.5})_{\text{Viking}} \leq (RPD_{.95})_{\text{Lab}}$ : **Precision Goal 2 Met** -- Viking performs comparably to conventional laboratory using accepted analytical methodologies.
  - (3) If  $(RPD_{.5})_{\text{Viking}} > (RPD_{.95})_{\text{Lab}}$ : **Precision Goal 2 Not Met** -- Viking precision performance is worse than that reported by reference laboratories despite considerable allowance given for field variability.

### Viking to Reference Laboratory Comparison

Two goals are stated. If the first goal is met, no evaluation is done relative to the second.

**Comparison Goal 1:** Median absolute percent difference is less than or equal to 50%.

**Comparison Goal 2:** If Goal 1 is not met, the Wilcoxon test result between Viking and reference laboratory data should indicate no statistically significant bias ( $p > 0.05$ ).

The specific evaluation procedure is as follows:

- Compute the percent difference and the absolute percent difference for each set of Viking to laboratory paired sample results.
- Compile the percent difference and absolute percent difference data into frequency histograms and compute the median  $(APD_{.5})_{\text{Viking-Lab}}$ , 80th percentile  $(APD_{.8})_{\text{Viking-Lab}}$ , and 95th percentile  $(APD_{.95})_{\text{Viking-Lab}}$  values for each distribution.
- Apply the following assessment criteria to the compiled absolute percent differences:
  - (1) If  $(APD_{.5})_{\text{Viking-Lab}} \leq 50\%$ : **Comparison Goal 1 Met** -- Viking results are consistently within  $\pm 50\%$  of reference laboratory results.
  - (2) If  $(APD_{.5})_{\text{Viking-Lab}} > 50\%$ : Proceed to Step (3) for further evaluation.
  - (3) Perform Wilcoxon test to determine if the observed bias is statistically significant. The percent difference values (not absolute percent difference values since the sign of the difference is necessary information in the Wilcoxon Test) are compared to a value of zero percent difference.
    - (a) If p-value for the test  $> 0.05$ : **Comparison Goal 2 Met**
    - (b) If p-value for the test  $< 0.05$ : **Comparison Goal 2 Not Met**

### ***Field Operation Observations***

Prior to the demonstration, a multi-point calibration was performed on the Viking GC/MS. This calibration was checked daily with a one-point calibration using an appropriate method for each sample media<sup>10</sup>. The single-point calibration samples were prepared from certified calibration standards that were diluted to bring the compound concentrations into the working range of the instrument. Results from the calibration check were required to meet pre-established acceptance criteria prior to proceeding with field sample analysis. Blanks were run after high concentration samples to verify the absence of sample contamination or carry-over prior to further sample analysis. At the end of analysis for each sample media, a final instrument calibration check was performed. Sample analyses results were prepared and submitted to the on-site Sandia team member at the end of each working day.

At SRS, the Viking instrument was transported from Viking corporate offices in Virginia and daily to and from the demonstration site in a passenger vehicle. On-site it was powered by a portable 1.5 kW generator. At the WAFB demonstration, the system was initially shipped in by air freight and subsequently transported to and from the site in a passenger vehicle. At WAFB, the system was operated from a line power source. At both sites the system was operated out of the back of a vehicle. An analytical chemist was the only operator and handler for the instrument except for the initial loading of the instrument into the vehicle. Environmental factors such as dust-laden air from dirt roads, cool mornings, and hot, humid afternoons at SRS did not appear to adversely affect the performance of the Viking as data accuracy and precision were generally consistent throughout the demonstrations. The ambient temperature extremes can be seen in temperature plots from SRS and WAFB in Figure 6-3 and 6-4, respectively. Relative humidity ranged from 40 to 90% during the demonstrations. Ancillary equipment used during the demonstrations included a roughing pump, generator, printer, and a small fan to aid in cooling the instrument during the hot, humid afternoons. Equipment setup took one field operator less than 30 minutes. No instrument mechanical or operating problems were observed at either demonstration site.

The analyst demonstrated a high level of competence in field analyses and instrument calibration. Quality control activities such as the daily calibration check, blank analysis after high concentration samples, and calibration checks at the end of each sample media all contributed to the production of high quality data from this particular instrument. During the analysis, a few analytical problems were encountered. Three high concentration samples exceeded the calibration range and the analyst flagged the data accordingly. The instrument was exposed to a large injection mass of methanol and analytes when a high-concentration spike sample in methanol was mistakenly analyzed without prior dilution. The large quantity of analytes introduced into the instrument overloaded the column and instrument detector. The analyst spent the remainder of the day and evening cleaning the instrument in order to bring instrument contamination down to tolerable levels. The analytical results for subsequent samples were unaffected by the contamination cleanup procedure

---

<sup>10</sup> One exception to this statement is that a three-point soil gas calibration was performed on-site at the SRS demonstration.

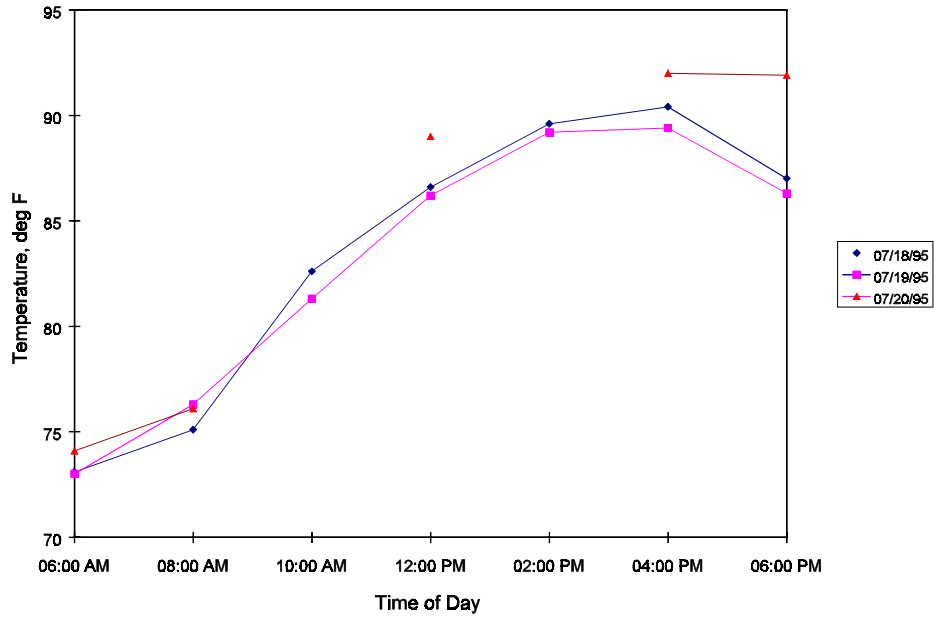

Figure 6-3. Plot of daily temperatures during the SRS demonstration. Note that two data points are missing from July 20, 1995

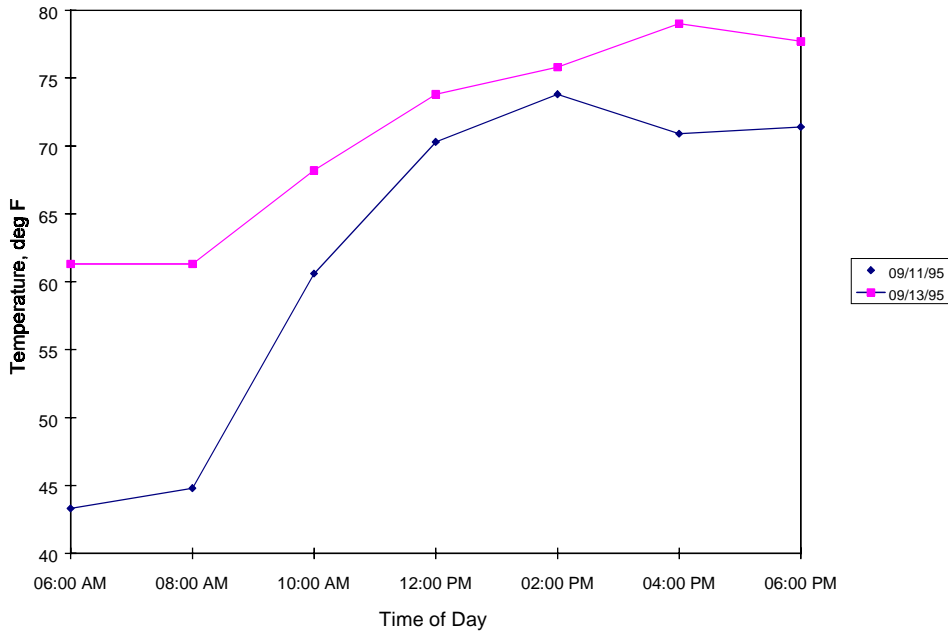

Figure 6-4. Plot of daily temperatures during the WAFB demonstration.

## Viking Accuracy and Precision Results

### Viking Accuracy -- SRS Demonstration

As discussed in Sections 4 and 5, SRS is contaminated with the chlorinated solvents TCE and PCE. Consequently, all of the Viking GC/MS data and corresponding laboratory data are limited to these two contaminants. Recovery data for the Viking GC/MS system for SRS spike and PE samples for water and soil gas are presented in Table 6-1. Data from reference values lower than the Viking PQL are not shown

in the table. Because of significant deviations from the demonstration plan, discussed earlier in Section 4, no data are available for assessment of Viking instrument accuracy on soil samples at SRS.

**Table 6-1. Viking GC/MS Recoveries at SRS.**

Sample Media / Description	Percent Recovery	
	TCE	PCE
Water Medium Spike	145	56
Water High Spike	252	138
Water PE No. 2	55	104
Soil Gas Medium Spike	148	133
Soil Gas High Spike	72	75
Soil Gas PE No. 2	219	202

Recoveries for the water spike and PE samples are generally satisfactory with five of six data points in the 50-150% range. Recoveries for soil gas measurements are also shown in Table 6-1. The level of confidence in the reference values for the soil gas spike samples is high since they were drawn from gas cylinders with accompanying certificates of analysis. The tabulated recoveries at the 100 ppm (medium spike) concentration level are greater than the reference values by factors ranging from about 1.3 to 2, revealing generally unsatisfactory accuracy performance of the Viking GC/MS for soil gas samples at this medium soil gas concentration level. Recoveries at the 1,000 ppm level are in the acceptable range.

#### **Viking Accuracy -- WAFB Demonstration**

The sampling media at the WAFB demonstration site are contaminated with a wide range of VOCs including petroleum hydrocarbons and chlorinated solvents. Approximately fifteen different VOCs were analyzed by both the reference laboratories and the field technologies, though several of these compounds were found in only trace amounts in the different media. A subset of analytes was chosen for accuracy and precision evaluation of the Viking GC/MS. The subset included benzene, toluene, ethylbenzene, and xylenes, as well as TCE and PCE. Unless otherwise noted, ethylbenzene is grouped with xylenes in the total xylenes category. Recovery data for the WAFB demonstration from Viking GC/MS analysis of PE and spike samples are presented for soil, water, and soil gas samples in Table 6-2.

**Table 6-2. Viking Recoveries at Wurtsmith.**

Sample Media Description	Percent Recovery				
	TCE	PCE	Benzene	Toluene	Total Xylenes
Soil PE No. 1	89	86	97	86	80
Soil PE No. 2	86	91	96	95	86
Water Low Spike	120	89	88	80	83
Water Medium Spike	79	91	89	80	85
Water High Spike	89	107	103	90	96
Water PE No. 1	NP	NP	104	NP	106
Water PE No. 2	83	111	101	119	129
Soil Gas Medium Spike	110	NP	128	NP	91
Soil Gas High Spike	109	NP	105	NP	131

Notes: NP = Not present in spike.

See Tables 5-7 and 5-11 for approximate target analyte concentrations in the various PE/Spike samples.



Two soil PE samples were available for accuracy determinations. These samples were laboratory-prepared in sealed ampules and were judged to be reliable standards. Viking GC/MS recoveries for the five target compounds fall in the range of 80 to 97% and reveal good accuracy performance for both chlorinated and non-chlorinated hydrocarbon target analytes. Computed recoveries from spike and PE water samples, also shown in Table 6-2, fall in the range of 79 to 129%, indicating that the Viking GC/MS performed acceptably with water sample media as well. Soil gas sample recoveries shown in Table 6-2 fall within the range of about 90 to 130% and indicate good Viking GC/MS accuracy performance with gas phase media.

### Overall Viking Accuracy Performance

The absolute percent accuracy values from both sites were compiled for the five target analytes by sampling media and are shown as histograms in Figures 6-5, 6-6 and 6-7 for soil, water, and soil gas, respectively. For soil, most of the values fall in the 0-20% range. The same is true for water, with 5 values in excess of 20%. The soil gas accuracy data generally fall in the 0-60% range, with 2 values falling outside of this range.

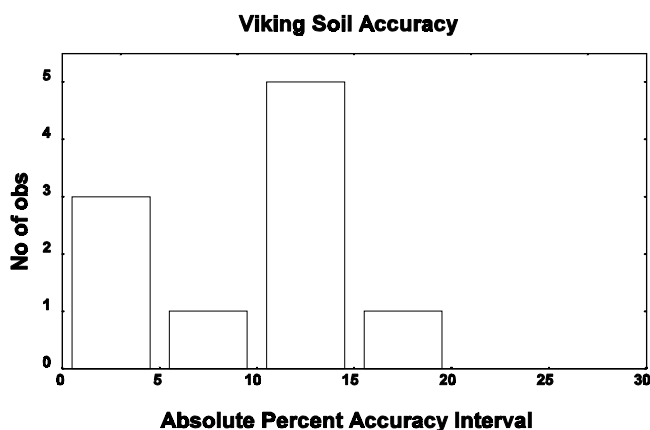

Figure 6-5. Absolute percent accuracy histogram for Viking soil samples.

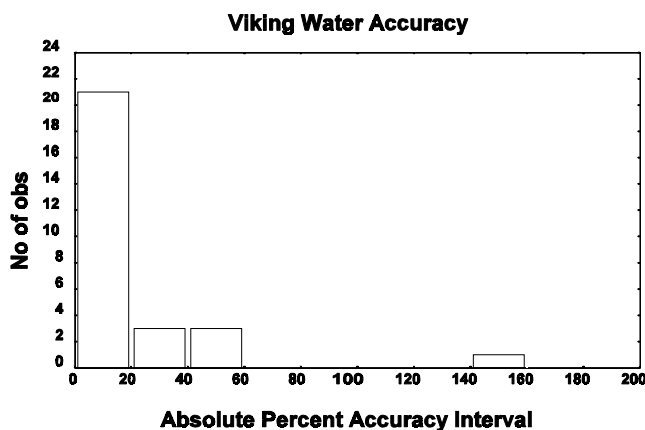

Figure 6-6. Absolute percent accuracy histogram for Viking water samples

Summary data from the absolute percent accuracy distributions are shown in Table 6-3 for the three sampling media. For example, the soil median absolute percent accuracy was 22% for the pooled reference laboratory data with the 95th percentile value at 47%. In comparison, the Viking soil median absolute percent accuracy was 13% with a 95th percentile value of 17%.

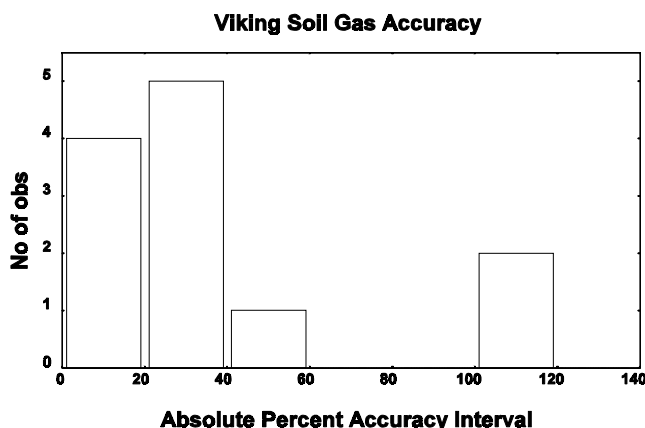

Figure 6-7. Absolute percent accuracy histogram for Viking soil gas samples.

Table 6-3. Viking and Reference Laboratory Accuracy Summary.

Data Set/Media Type	Absolute Percent Accuracy			
	n	x <sub>.5</sub>	x <sub>.8</sub>	x <sub>.95</sub>
Ref. Lab - Soil	10	22	36	47
Viking - Soil	10	13	14	17
Ref. Lab - Water	30	19	27	116
Viking - Water	28	14	26	45
Ref. Lab - Soil Gas	24	20	47	66
Viking - Soil Gas	12	28	45	110

Note: x<sub>.5</sub> = 50th percentile (median); x<sub>.8</sub> = 80th percentile; x<sub>.95</sub> = 95th percentile

Assessment of Viking performance in terms of the accuracy goals stated previously results in the following determinations:

**Soil:** (APA<sub>.5</sub>)<sub>Viking</sub> <30%: **Accuracy Goal 1 Met**

**Water:** (APA<sub>.5</sub>)<sub>Viking</sub> <30%: **Accuracy Goal 1 Met**

**Soil Gas:** (APA<sub>.5</sub>)<sub>Viking</sub> <30%: **Accuracy Goal 1 Met**

Viking accuracy performance is acceptable in terms of established performance goals for all sampling media.

### Viking Precision -- SRS Demonstration

Viking GC/MS RPD values from the SRS demonstration are presented in Table 6-4 and are based on the results of duplicate sample analysis. No precision determination was done on SRS soil sample data, as discussed previously.

The RPD values for the water samples are generally less than 20%, indicating good precision for the Viking GC/MS. As expected, the precision is not as good on the results of the low concentration samples near the Viking PQL; however, in nearly all cases the RPD values are less than 20%.

**Table 6-4. Viking Precision for SRS Demonstration.**

Sample Media / Description	Relative Percent Difference	
	TCE	PCE
Water Low	21	20
Water Medium	1	6
Water High	6	6
Soil Gas Medium	1	2
Soil Gas High	4	2

Notes: The Water/Low sample is below the Viking PQL and RPD values are not used in statistical calculations.

Soil gas duplicate samples were actually soil gas samples drawn sequentially from each well within a time interval of about 2 minutes. The degree of chemical equivalence of these sequential samples could not be determined since a real-time measure of soil gas species was not made at the wellhead during collection. In this analysis, a worst case precision determination was carried out by assuming that the sequential samples were chemically equivalent. The RPD values for the medium and high vapor samples, given in Table 6-4, are in the range of 1 to 4%, indicating good precision performance.

### Viking Precision -- WAFB Demonstration

The precision data for the WAFB demonstration are presented in Table 6-5. The tabulated RPD values are based on the analysis of a number of duplicate samples for each media.

**Table 6-5. Viking Precision for Wurtsmith Demonstration.**

Sample Media / Description	Relative percent difference				
	TCE	PCE	Benzene	Toluene	Total Xylenes
Soil Low Sample	NP	NP	20	29	59
Soil Medium Sample	NP	NP	3	10	13
Soil High Sample	NP	NP	NP	13	1
Water Low Sample	NP	NP	13	NP	8
Water Medium Sample	NP	NP	3	4	3
Water High Sample	NP	<1	4	NP	1
Soil Gas Low Sample	NP	NP	6	NP	11
Soil Gas Medium Sample	NP	NP	<1	NP	2
Soil Gas High Sample	NP	NP	3	NP	5

Notes: NP = Not present; Analyte was either below detection or not present in the sample.

See Tables 5-9 and 5-13 for approximate target analyte concentrations in the listed samples.

Only limited data were available for soil precision evaluations since none of the samples had detectable levels of TCE and PCE. A high RPD value of 59% was encountered for a duplicate measurement of total xylenes in a low level sample. Reference laboratory data reveal that xylene content in this sample was below the Viking PQL.

Calculated RPD values for three different concentration levels in water are less than 13%, revealing good instrument precision for water analysis.

As noted earlier in the discussion of SRS demonstration results, the duplicate soil gas samples were actually samples drawn sequentially from different levels of the well. The assumption is made that the sequential samples are chemically equivalent. Thus, the RPD value represents a worst-case estimate of

Viking GC/MS precision since some of the variability encountered in the analysis result may in fact be attributable to variation between two sequential samples. The RPD values for the vapor samples all fall below 20% and indicate good instrument precision for the soil gas samples.

### Overall Viking Precision Performance

The relative percent differences for both sites were compiled by sample media and are shown as histograms in Figures 6-8, 6-9 and 6-10 for soil, water, and soil gas, respectively. For the soil samples, nearly all of the RPD values fall in the 0-30% range. For water and soil gas samples, all values fall in the 0-15% range.

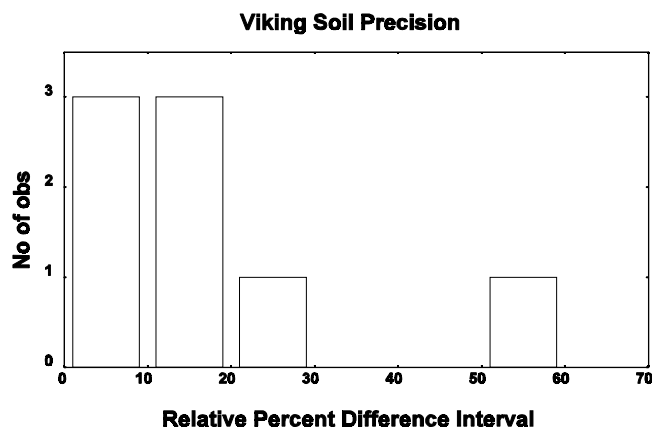

Figure 6-8. Relative percent difference histogram for Viking soil samples.

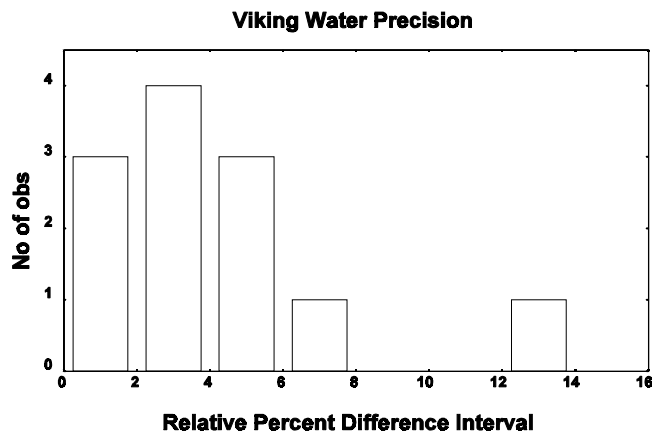

Figure 6-9. Relative percent difference histogram for Viking water samples.

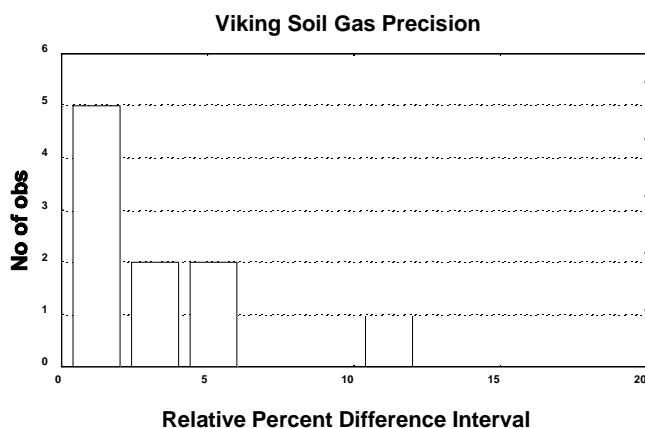

Figure 6-10. Relative percent difference histogram for Viking soil gas samples.

Summary data from the relative percent difference distributions are shown in Table 6-6 for the three sampling media.

Table 6-6. Viking and Reference Laboratory Precision Summary.

Data Set/Media Type	n	Relative Percent Difference		
		$x_{.5}$	$x_{.8}$	$x_{.95}$
Ref. Lab - Soil	13	8	13	58
Viking - Soil	8	13	25	49
Ref. Lab - Water	14	5	10	22
Viking - Water	15	6	11	20
Ref. Lab - Soil Gas	17	7	20	68
Viking - Soil Gas	10	3	5	9

Note:  $x_{.5}$  = 50th percentile (median);  $x_{.8}$  = 80th percentile;  $x_{.95}$  = 95th percentile

Viking performance with respect to precision goals are as follows:

<b>Soil:</b>	$(RPD_{.5})_{\text{Viking}}$	<25%	<b>Precision Goal 1 Met</b>
<b>Water:</b>	$(RPD_{.5})_{\text{Viking}}$	<25%	<b>Precision Goal 1 Met</b>
<b>Soil Gas:</b>	$(RPD_{.5})_{\text{Viking}}$	<25%	<b>Precision Goal 1 Met</b>

Viking precision performance, relative to established performance goals, is judged acceptable for all sampling media. The median relative percent difference values for all three sampling media were in the range of 0-25%.

### ***Viking to Reference Laboratory Data Comparison***

As discussed earlier in this section, comparisons of the Viking GC/MS analytical data with the reference laboratory analytical data for soil, water and soil gas samples are presented in a number of formats that include log-log scatter plots, percent difference histograms, and formal performance assessment in light of established goals. Reported values that were less than two times the Viking GC/MS PQL (soil: 5  $\mu\text{g}/\text{kg}$ ; water: 5  $\mu\text{g}/\text{L}$ ; soil gas: 5 ppm) are plotted; however, they are not included in any of the statistical analyses.

### **Scatter Plots/Histograms -- SRS Demonstration**

Target analytes at this site were limited to TCE and PCE. The GEL water data were given a good ranking, as discussed previously in Section 5, and are used as the reference data set. The on-site SRS laboratory soil gas data were judged to be an acceptable reference data set.

Plots of Viking GC/MS water analyses results for TCE and PCE are given versus the reference data in Figure 6-11 and Figure 6-12 for low (1-100  $\mu\text{g/L}$ ) and high (0.1-100  $\text{mg/L}$ ) concentration ranges, respectively. All but 2 points fall within the  $\pm 50\%$  interval about the zero bias line as shown on the plots. The distribution of percent difference values is shown as a histogram in Figure 6-13. A clustering of values on the negative side of the histogram suggests an overall negative bias in the Viking data relative to the laboratory data.

A plot of the Viking soil gas data for TCE and PCE relative to the SRS reference laboratory data is shown in Figure 6-14. Eight of the 12 plotted values fall outside the  $\pm 50\%$  bias lines. The accompanying histogram is shown in Figure 6-15.

### **Scatter Plots/Histograms -- WAFB Demonstration**

As outlined in Section 5, the Traverse laboratory data were given a good ranking for soil and water sample analyses. These data are used as reference data for comparison with Viking GC/MS results. The Pace laboratory data were given a satisfactory ranking for soil gas analysis and are used as the reference data set for the soil gas measurements.

Considerably more compounds were detected in the various samples at the Wurtsmith AFB than at the Savannah River Site, which was limited to TCE and PCE. For the Wurtsmith demonstration, all target analytes have been combined in the plots and statistical analysis.

A plot of Viking data versus Traverse data for all soil analyses is presented in Figure 6-16. Nearly all the data points fall within the  $\pm 50\%$  margin lines shown on the plot. The percent difference histogram, shown in Figure 6-17, shows most values in the -60 to 100% range.

Plots of Viking data versus Traverse data for all water analyses are presented in Figures 6-18 and 6-19 for the low ( $\mu\text{g/L}$ ) and high ( $\text{mg/L}$ ) ranges, respectively. Nearly all Viking values fall within the  $\pm 50\%$  margins shown on the plots. The percent difference histogram (Figure 6-20) shows a clustering of nearly all the values in the -50 to 50% range.

A scatter plot of Viking GC/MS data versus Traverse data for all soil gas analyses is presented in Figure 6-21. The high spike sample data which were in excess of 100 ppm are not included since the analysis of Pace data in Section 5 showed poor results for these high concentration samples. Ten of a total of 27 plotted values fall outside the  $\pm 50\%$  margins shown on the plot. Nearly all values outside the  $\pm 50\%$  margins fall on the high side. This is also indicated in the histogram shown in Figure 6-22, revealing an overall positive bias in the Viking data relative to the reference laboratory data.

Viking vs. Laboratory - SRS Water (Low)

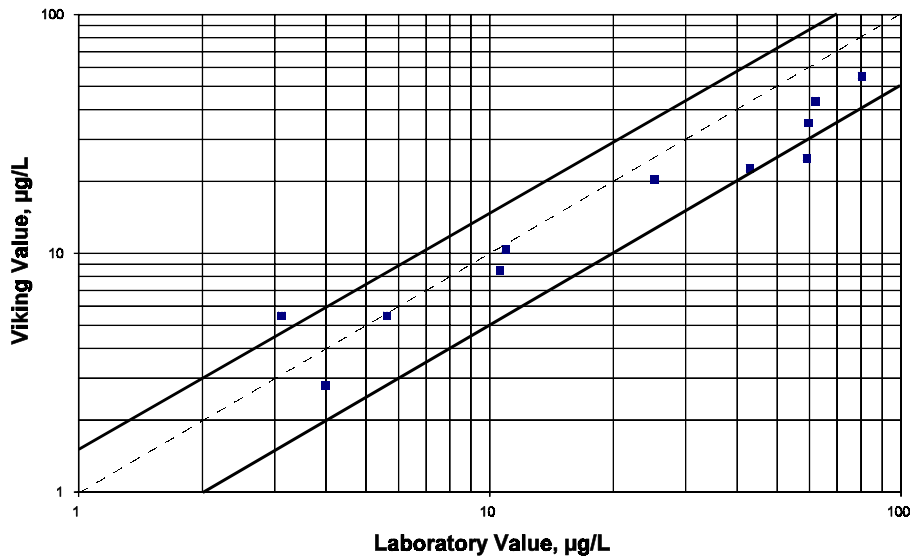

Figure 6-11. Viking vs. Laboratory data for SRS low concentration water samples. The solid lines show the  $\pm 50\%$  range about a zero-bias (dashed) line.

Viking vs. Laboratory - SRS Water (High)

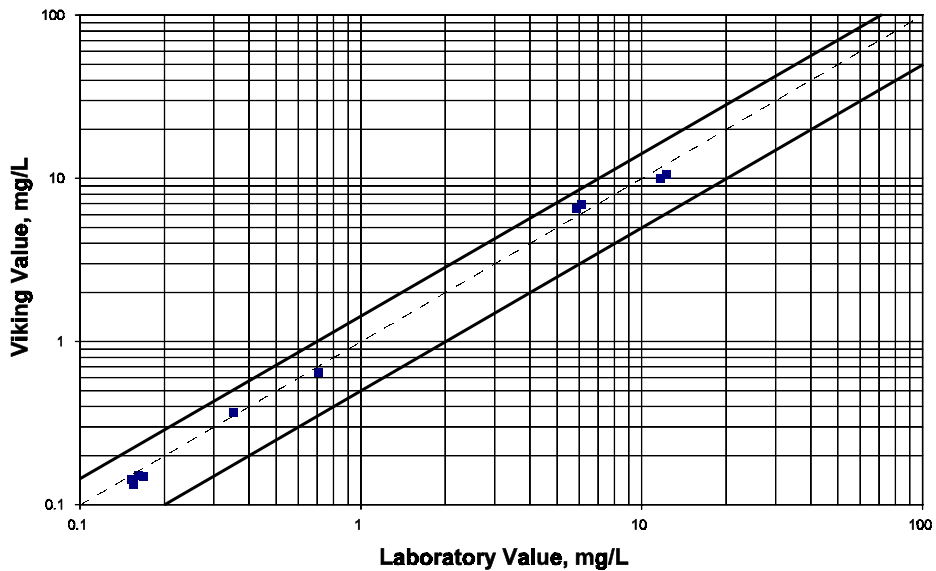
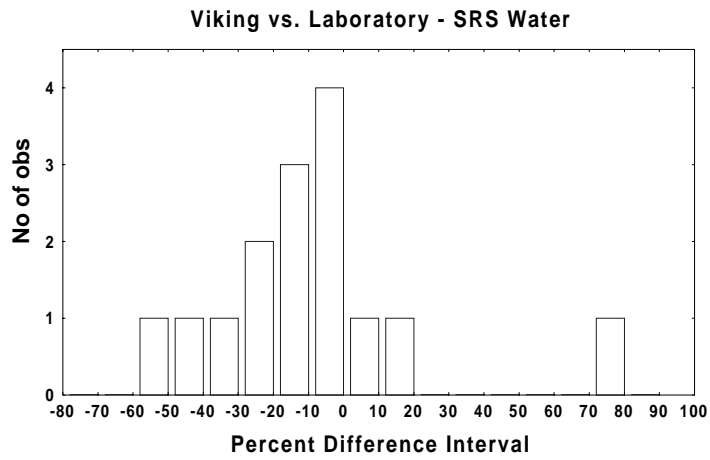
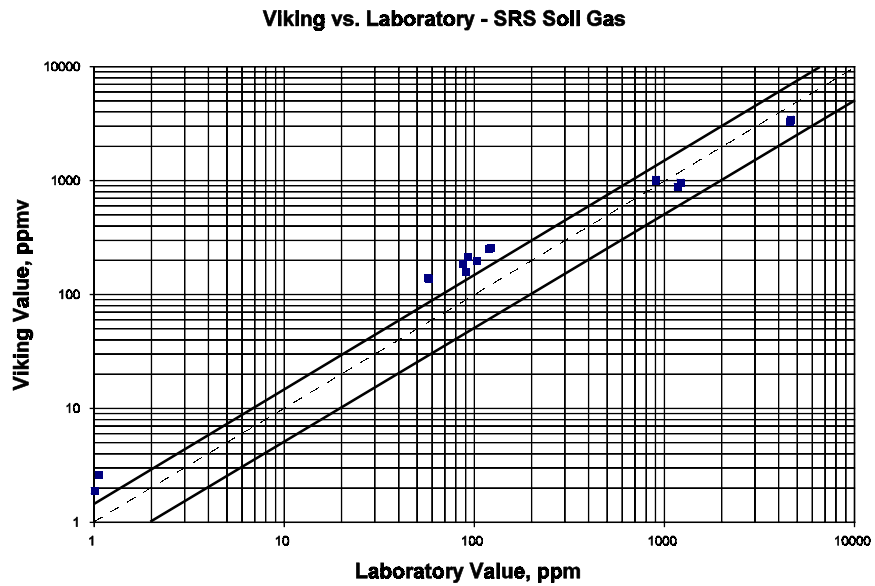

Figure 6-12. Viking vs. Laboratory data for SRS high concentration water samples. The solid lines show the  $\pm 50\%$  range about a zero-bias (dashed) line.



**Figure 6-13. Percent difference histogram for SRS water samples.**



**Figure 6-14. Viking vs. Laboratory data for SRS soil gas samples.**

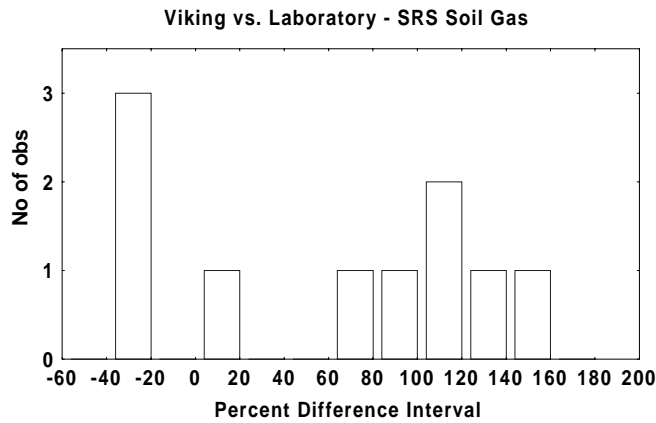

**Figure 6-15. Percent difference histogram for SRS soil gas samples.**



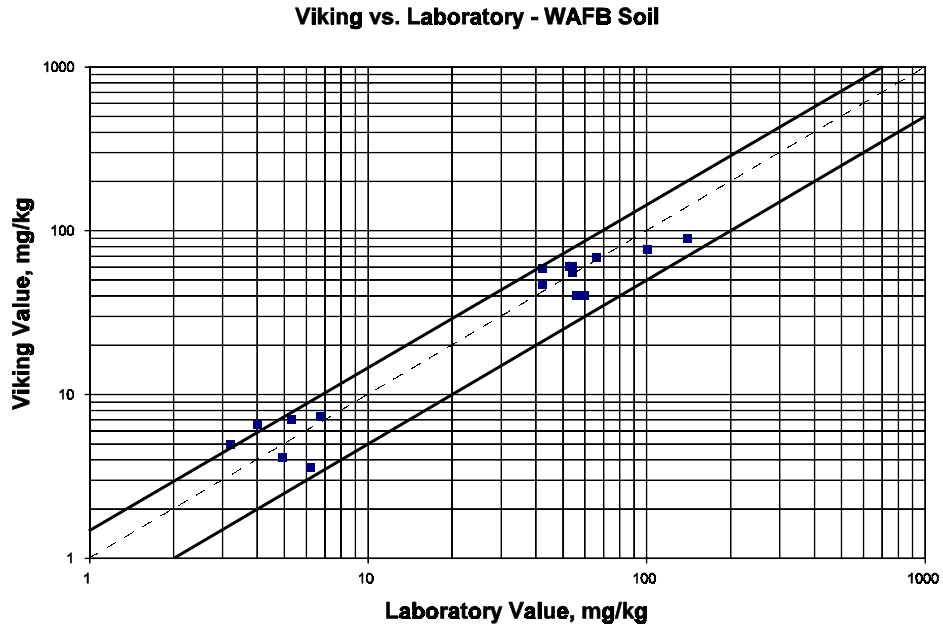

Figure 6-16. Viking vs. Laboratory data for WAFB soil samples.

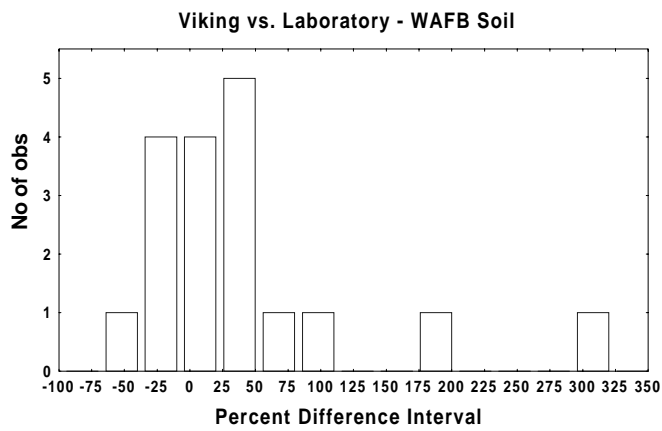
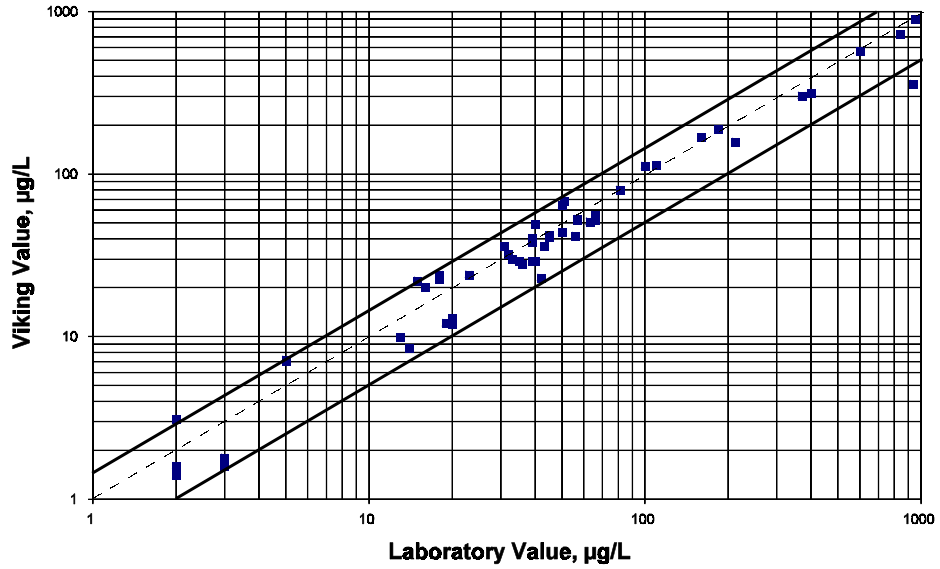

Figure 6-17. Relative percent difference histogram for WAFB soil samples.

**Viking vs. Laboratory - WAFB Water (Low)**



**Figure 6-18. Viking vs. Laboratory data for WAFB low concentration water samples.**

**Viking vs. Laboratory - WAFB Water (High)**

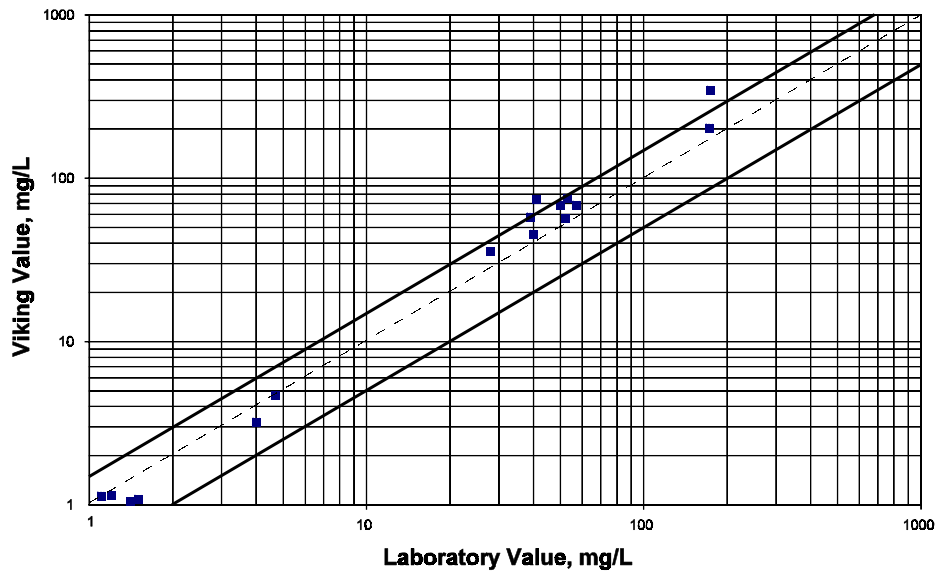

**Figure 6-19. Viking vs. Laboratory data for WAFB high concentration water samples.**

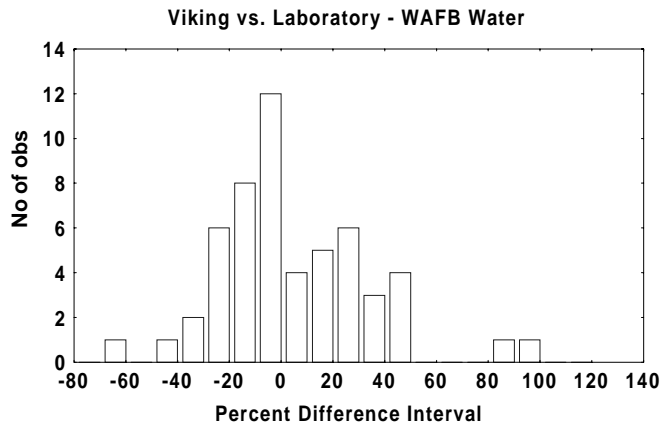

Figure 6-20. Relative percent difference histogram for WAFB water samples.

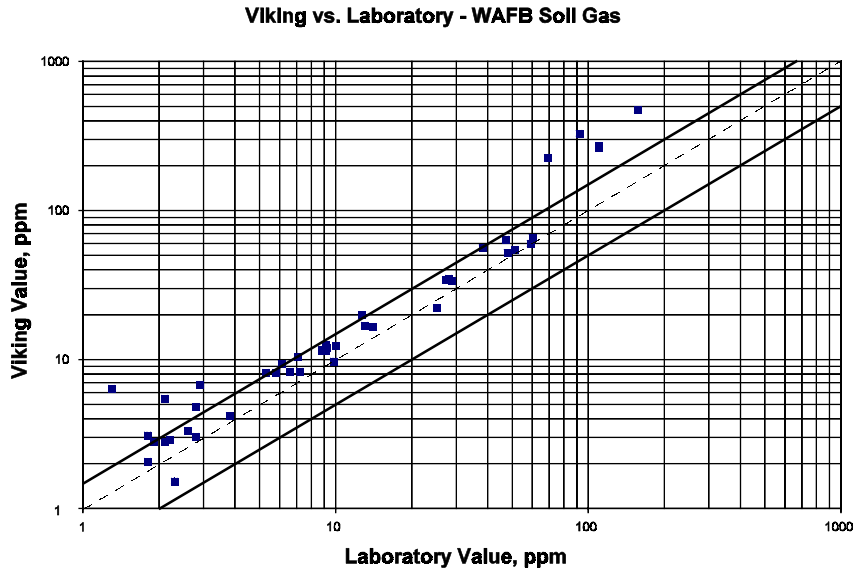

Figure 6-21. Viking vs. Laboratory data for WAFB soil gas samples.

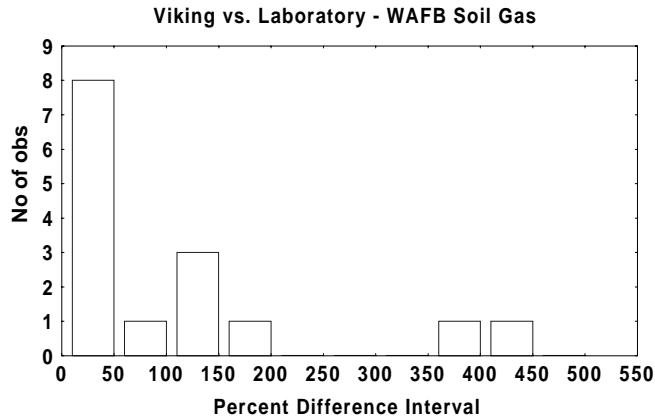

Figure 6-22. Relative percent difference histogram for WAFB soil gas samples.

## Overall Viking to Laboratory Comparison Results

Absolute percent differences from both sites were compiled by sampling media and are shown as histograms in Figures 6-23, 6-24, and 6-25 for soil, water, and soil gas, respectively. For soil, most of the absolute percent difference values fall in the 0-60% range. For water, most of the absolute percent difference values fall in the 0-50% range. In the case of soil gas, nearly all of the absolute percent difference values fall in the 0-200% range.

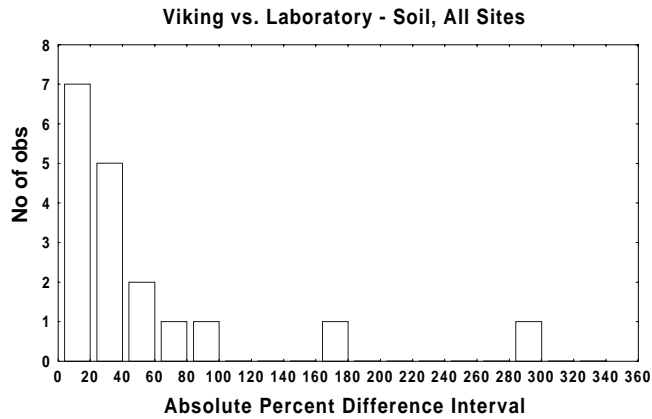

Figure 6-23. Absolute percent difference histogram for soil samples.

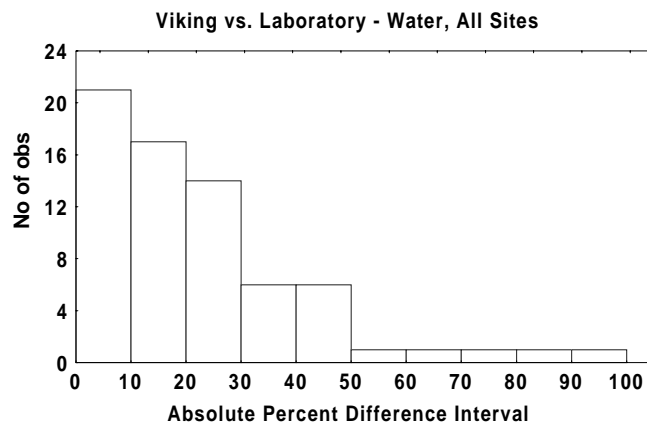

Figure 6-24. Absolute percent difference histogram for water samples.

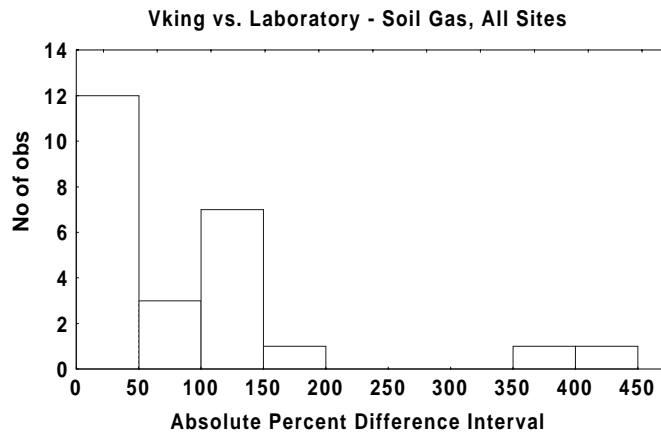

Figure 6-25. Absolute percent difference histogram for gas samples.

Summary data from the three absolute percent difference distributions for the three sampled media are shown in Table 6-7.

Table 6-7. Viking-Laboratory Comparison Summary.

Media Type	n	Absolute Percent Difference		
		X <sub>5</sub>	X <sub>8</sub>	X <sub>95</sub>
Soil	18	32	61	196
Water	69	18	31	60
Soil Gas	25	57	133	353

Viking performance assessment in terms of the comparison goals result in the following determinations:

<b>Soil:</b>	(APD <sub>.5</sub> ) <sub>Viking-Lab</sub>	<50%:	<b>Comparison Goal 1 Met</b>
<b>Water:</b>	(APD <sub>.5</sub> ) <sub>Viking-Lab</sub>	<50%:	<b>Comparison Goal 1 Met</b>
<b>Soil Gas:</b>	(APD <sub>.5</sub> ) <sub>Viking-Lab</sub>	>50%:	<b>Comparison Goal 1 Not Met</b>
<b>Wilcoxon test result:</b>		p < 0.01:	<b>Comparison Goal 2 Not Met</b>

Viking data are judged to be comparable to reference laboratory data for soil and water; however, the performance criteria were not met for soil gas.

**Summary of Viking Accuracy, Precision, and Laboratory Comparison Performance**

An overall summary of Viking GC/MS performance for both demonstration sites is given in Table 6-8. The results of the foregoing evaluation of the Viking GC/MS performance goals are summarized with respect to accuracy, precision, and a comparison of the Viking GC/MS results to that of the reference laboratory.

The summary information in the table shows that the Viking GC/MS met performance goals in eight of the nine evaluation categories. The Viking soil gas data were determined not to be comparable to the reference laboratory data; however, Viking accuracy and precision was determined to be acceptable on

**Table 6-8. Summary Performance of the Viking GC/MS.**

<b>Sample Medium</b>	<b>Accuracy via PE/Spike Samples</b>	<b>Precision via Duplicate Analyses</b>	<b>Viking-Lab Data Comparison</b>	<b>Reference Lab Data Quality</b>
Soil	Goal Met	Goal Met	Goal Met	SRS: Undetermined WAFB: Good
Water	Goal Met	Goal Met	Goal Met	SRS: Good WAFB: Good
Soil Gas	Goal Met	Goal Met	Goal Not Met	SRS: Satisfactory WAFB: Satisfactory

the basis of their analytical results for PE, spike, and duplicate samples. The result of the Wilcoxon test on the soil gas data indicates that the observed difference between Viking and reference laboratory data cannot be explained by random variation alone and it is likely that some other factor is causing the Viking data to be high relative to the laboratory data. Possible influential factors could be calibration, sampling handling, or injection error by either Viking or the reference laboratory.

### ***Other Viking GC/MS Performance Indicators***

#### **Unknown Compound Identification in Complex Mixtures**

The ability of the instrument to identify a broad range of compounds in complex mixtures was also amply demonstrated with many of the WAFB samples. In addition to identification and quantification of target analytes, the Viking analyst also compared the mass spectra of additional non-target analyte chromatographic peaks to a computerized mass spectrum library of many compounds. An example Viking total ion chromatogram of water sample containing numerous volatile organic compounds is shown in Figure 6-26. A partial listing of the library search results, called tentatively identified compounds, for this sample is shown in Table 6-9.

#### **Field Handling and Operation**

The Viking SpectraTrak™ 672 GC/MS is designed to be shipped to the field and is shock mounted for durability in handling and field use. At approximately 140 pounds, the system was easily transported to and around each site in a standard passenger vehicle. For the WAFB demonstration, the system was transported by air freight to Michigan. The ruggedized design contributed to stable instrument calibrations over the duration of each demonstration, despite several days of travel on dirt roads during the course of the demonstration. At each site, the system was operated for several days in a row, typically 8-10 hours per day. The instrument was exposed to ambient temperatures ranging from 40° to 95° F. During both demonstrations, the instrument operated properly and without breakdowns or mechanical problems.

System set-up was simple and uncomplicated. Set-up procedures involved connecting the ancillary equipment and checking the instrument calibration. About 30 minutes were required for set-up and another 30 minutes for calibration checks. Following these two activities, the instrument was ready for sample analysis. Sample analysis time varied according to the sample media and the mode of injection; however, a typical time interval was on the order of 30 minutes per sample. Hard copy data were available for each day's analysis at the completion of the work day.

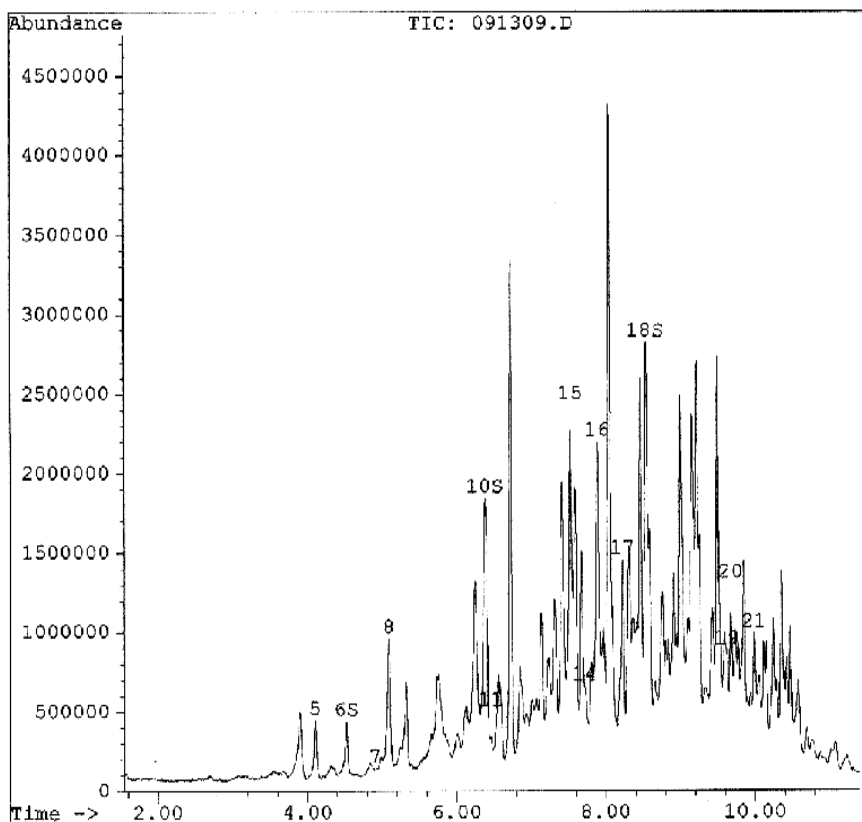

Figure 6-26. Viking GC/MS total ion chromatogram from a WAFB water sample.

### Overall Viking GC/MS Performance Conclusions

Table 6-9. Tentatively Identified Compounds from a Wurtsmith Water Sample Analysis.

Methyl-cyclopentane	2,3-Dimethyl-2-pentene
5-methyl-1H-tetrazole	4,4-Dimethyl-2-pentene
Ethyl-cyclobutane	Propyl-benzene
1-Methylethyl-cyclopropane	1-Ethyl-3-methyl-benzene
2-Methyl-1-pentene	1-Ethyl-2-methyl-benzene
Cyclohexane	1-Ethyl-2-methyl-benzene
2-Methyl-cyclobutanone	1,2,3-Trimethyl-benzene
Methyl-cyclohexane	1,2,4-Trimethyl-benzene
4,5-Dihydro-1,5-dimethyl-1H-pyrazole	

The Viking SpectraTrak™ 672 GC/MS system was tested at two locations during this technology demonstration in order to evaluate its capabilities and performance during on-site analysis of VOC contaminated soil, water, and soil gas samples. The objectives of the demonstration were to assess instrument performance goals and to evaluate logistical and operational capabilities such as system reliability, ruggedness and ease of operation. The system performance goals are summarized in Table 6-10 along with an assessment, based on the data produced in this demonstration, as to whether these goals were met.

As shown in Table 6-10, the instrument performance goals of the Viking GC/MS were met with one exception. Instrument performance in terms of accuracy and precision met the stated performance goals. The Viking data were determined to be comparable to that of reference laboratories for soil and water; however, the data were not comparable for soil gas analyses. Questions remain as to whether the Viking soil gas data, or that of the reference laboratory, or both are inaccurate. In either case, the extent of deviation of Viking and reference laboratory results for soil gas samples, while significant, is not so great as to preclude the system's effective use in many field screening applications. Performance goals related to sample throughput rate, data completeness, ease of field calibration, and data availability were met.

**Table 6-10. Summary of Viking Performance Goals and Actual Performance.**

<b>Performance Goal</b>	<b>Performance</b>	<b>Goal Met?</b>
<b>ACCURACY:</b> Median absolute percent accuracy within 30% of reference value; or, Median accuracy comparable to reference laboratory accuracy.	For all media, generally better than 30% accuracy; always comparable to reference laboratories.	Water: Yes Soil: Yes Soil Gas: Yes
<b>PRECISION:</b> Median relative percent difference within 25%; or, Median relative percent difference comparable to laboratory precision.	For all media, generally within 25% RPD; always comparable to reference laboratories.	Water: Yes Soil: Yes Soil Gas: Yes
<b>REFERENCE LABORATORY DATA COMPARISON:</b> Median absolute percent difference less than or equal to 50%; or, if greater than 50%, no significant bias via statistical test.	Less than 50% for soil and water; not comparable for soil gas.	Water: Yes Soil: Yes Soil Gas: No
<b>COMPLETENESS:</b> At least 95% of target compounds detected by reference laboratory also detected by Viking.	Soil > 99% Water > 99% Soil Gas > 99%	YES
<b>SAMPLE THROUGHPUT:</b> Depends on methodology. Samples requiring concentration may run for 30 minutes apiece. Direct injections average 10-15 min. apiece. Direct membrane analyses can be performed several times per minute.	Sample analysis times were less than or equal to those claimed.	YES
<b>CALIBRATION:</b> The instrument will be initially calibrated before arriving at the demonstration site and simple calibration checks performed daily.	As stated in goal.	YES
<b>DATA:</b> Quantitative results will be submitted at the end of the demonstration. The data analysis software is also capable of full, detailed reports which include ion chromatograms, spectra, library searches, and calibration reports. Detailed data can be submitted when time permits.	Data were submitted on the same day of the analysis, all data submitted by demo end.	YES
<b>DEPLOYMENT:</b> The Viking SpectraTrak™ can be set up and ready to run within 30 minutes.	The system was ready to run samples in ≤30 min.	YES



## **Section 7**

### **Applications Assessment**

The Viking SpectraTrak™ 672 field portable GC/MS instrument has been demonstrated during this verification effort at two geologically and climatologically different sites with a wide range of volatile contaminants. The instrument was used to analyze, on-site and in near real time, samples taken from three media; soil gas, water, and soil. The use of field analytical instruments is emerging as a supplement to and possible replacement for conventional laboratory off-site analysis. As demonstrated, the Viking field portable GC/MS system has application to several field screening and analysis scenarios

#### ***Applicability to Field Operations***

From a logistical viewpoint, at a weight of 145 lb, the system is easily transportable and is ruggedized for field handling. The Viking system is self-contained and includes an internal computer and internal carrier gas source. These features, along with its compact design, preclude the need for a specialized vehicle during field operations. The system can easily be operated from a rental car or van. Required external ancillary equipment includes a roughing pump, portable printer, and power source. The system can be operated reliably in the field over a wide range of temperature and relative humidity. System setup and operation can be conducted by one person. The system utilizes data handling and analysis software common to that of basic GC/MS technologies.

#### ***Capital and Field Operation Costs***

On-site field analysis of samples has the potential to reduce overall site characterization and clean-up costs. Real-time and on-site analysis of samples can provide immediate direction to a sampling team during site characterization, thus reducing both the number of sampling trips to the site and the number of samples to be analyzed. Additionally, real-time analysis of samples during site remediation can often minimize the amount of material treated, thus reducing both remediation costs and the time required for site cleanup. The actual cost savings that can be realized from the field analysis of samples depends on many factors. These include: the capital costs of the field analysis system; field operation costs for equipment, supplies, travel, and per diem; labor and overhead costs; sample analysis requirements; and the overall utilization rate of the field instrument.

Capital and field operation costs for the Viking SpectraTrak™ 672 were determined during the demonstration and are presented in Table 7-1. Estimates of average sample analysis rates for laboratory quality and sample screening analysis modes for the Viking instrument are also provided. Actual sample analysis rates will vary as a function of the media and contaminants being analyzed. The values provided in Table 7-1 can be used as a guide in assessing the utility and cost effectiveness of using this type of field analysis system for various applications.

#### ***Discussion of the Technology***

##### **Rapid Analysis**

The use of the Viking field transportable GC/MS system provides near-real-time analysis of samples on-site. This approach is significantly faster than laboratory methods and expedites real-time decision making in the field. This is especially important in guiding sampling activities. Near-real-time analysis of samples on-site may eliminate the need and cost of return trips to the field to collect additional samples.

**Table 7-1. Viking SpectraTrak™ 672 GC/MS Capital and Field Operation Costs.**

<u>Capital Costs</u>	
Viking SpectraTrak™ 672 GC/MS (90 day warranty)	\$145K
Ancillary Equipment - Roughing pump, generator	\$ 7K
Five-year service contract	\$ 60K
Training (2 people for one week)	<u>\$ 3K</u>
<i>Total</i>	\$215K
Annualized system costs for five years ( $\$215K \div 5$ years)	\$43K/year
Maintenance (annually 10% of capital costs)	
Includes new columns, preventive maintenance, software and hardware upgrades, etc.	<u>\$ 1.5K/year</u>
Five-year annual capital and maintenance costs	\$44.5K/year
<u>Field Operation Costs</u>	
Field Chemist labor (\$60K/year including overhead)	\$230/day
Per diem (lodging and meals)	\$100/day
Vehicle rental	\$ 50/day
Supplies and consumables (standards, syringes, vials, gas, etc.)	<u>\$ 70/day</u>
<i>Total</i>	\$450/day
<u>Sample Analysis Rates</u>	
Laboratory Quality Sample Analysis	15 samples/day
Field Screening Sample Analysis	50 samples/day

### Sampling and Sample Cost

The major cost saving obtained by the use of field analyses is the reduction in time required to obtain the analytical results needed for decision making. As operated during this demonstration, the Viking SpectraTrak™ 672, in most cases, produced good quality data in the field. The ability to generate good quality analyses in near real-time allows decisions to be made concerning the extent and completeness of cleanup operations while field equipment is still mobilized.

This can result in significant cost reductions by eliminating re-mobilizations or the removal of extra materials to be assured that the cleanup is complete. Similar savings can be achieved during site characterization by eliminating the need for multiple sampling mobilizations as additional sampling efforts can be directed based on real-time data.

### Performance Advantages

The developer's performance specifications for the Viking field transportable GC/MS were evaluated and, when compared to standard laboratory methods, were statistically equivalent. This demonstration showed that for samples whose contaminant concentration determinations are very sensitive to shipping and analysis time delays, such as VOC soil gas samples, that on-site analysis directly after the samples are obtained consistently provides higher results than the laboratory methods. Therefore, for some analytes like VOCs, on-site analysis can be expected to provide results that are more representative of actual site conditions and are more accurate than laboratory methods.

## **Transportability**

The ruggedness of the Viking GC/MS was illustrated by its shipment via air freight to the WAFB site and by its daily transportation in a vehicle to and from the demonstration sites. The system is essentially self contained and does not need a dedicated support vehicle or excessive ancillary equipment. At about 145 lb it can be easily transported around sites and operated out of the back of a rental car or van. This ruggedness and portability provides the system with the capability for laboratory quality sample analysis at most locations.

## **Field Screening of Samples**

The system capabilities for transportability and real-time analysis make the instrument extremely useful as a tool for site characterization and monitoring activities. The instrument may be used as a high volume screening tool to guide sampling and remediation efforts or to provide higher quality analyses on selected samples. The capability to identify unknown compounds with the portable GC/MS enables a site manager to investigate a site for a wide range of contaminants at a single time. The use of the system as a screening tool to guide sampling efforts in the field can provide significant cost savings in terms of the number of samples analyzed and will reduce the need for return trips to the field.

## **Interferences**

Interferences from water vapor or other contaminants can affect the field transportable GC/MS systems as well as the fixed-laboratory GC/MS systems. The presence of interferents should be checked by periodic analysis of reagent blanks and is required with both laboratory and field GC/MS systems. Since reagent blank analysis requires about 30 minutes, the sampling speed is not significantly affected.

## **Conclusions**

The Viking SpectraTrak™ 672 Field Transportable GC/MS provides good quality sample analysis on-site and in near-real-time. The technology may offer time and cost saving advantages over conventional sampling and laboratory analysis strategies. The system complements conventional laboratory analysis and can add significant benefits in terms of defining the nature and extent of contamination at a site. The limitations of the system are generally related to the underlying operational considerations associated with the basic use of GC/MS technologies.

## **Section 9 Previous Deployments**

Stringfellow Toxic Waste Dump Site, Southern California (July 1993). Volatile organic compounds in soil performed by Viking for US EPA Region 9. Contact Vance Fong, Section Chief, Phone: (415) 744-1492.

Antioch, California (July 1993): Volatiles in groundwater, performed for Region 9 of the EPA at a CERCLA site near the Sacramento River in Northern California. Contact Vance Fong, Section Chief, Phone: (415) 744-1492.

Air and Soil Screening, EPA Region 5 (September 1993). Air screening analysis for health and safety at a dumpsite near the Great Lakes region performed for EPA Region 5. Contact Rod Turpin, Phone: (908) 321-6762.

Superfund Site, Virginia, (August 1993). Analysis of volatiles and semivolatiles performed by the Environmental Resources Management, Inc. with a Viking SpectraTrak™. Contact David Gallis, Environmental Resources Management, Inc., Phone: (610) 524-3786.

Sandia National Laboratories, (1993). Soil Vapor Analysis of soil vapor samples extracted from various depths using a GeoProbe. Contacts are Sharissa Young, Phone: (505) 845-3226 or Wyatt Booher, Phone: (505) 269-3207.

SpectraTrak™ Transportable GC/MS U.S. Military Endurance Testing (1993) at Dugway Proving Ground. Contact R. J. Black, Phone: (801) 831-3371.

## Section 10

### References

- Bury, K. V. 1975. *Statistical Models in Applied Science*, John Wiley & Sons, New York.
- Conover, W.J. 1980. *Practical Nonparametric Statistics, 2nd Ed.*, John Wiley & Sons, New York, pp 281-288.
- Iman, R.L. 1994. *A Data-Based Approach to Statistics*, Duxbury Press, Belmont, California, pp 349-382.
- National Center for Integrated Bioremediation Research and Development. 1995. "Draft Field Sampling Plan," University of Michigan, Ann Arbor, Michigan.
- Rossabi, J. 1996. Personal Communication, April 1996.
- Sandia National Laboratories. 1995. "Demonstration Plan for the Evaluation of Field Transportable Gas Chromatography/Mass Spectrometers," Albuquerque, New Mexico.
- SAS Institute Inc. 1985. "SAS Users Guide: Statistics, Version 5 Edition," Cary, North Carolina.
- U.S. Environmental Protection Agency. 1987. "Method 8260: Gas Chromatography/Mass Spectrometry for Volatile Organics: Capillary Column Technique, as contained in Test Methods for Evaluating Solid Waste, Physical/Chemical Methods, SW-846, 3rd Edition." Research Triangle Park, North Carolina. EPASW-846.3.1.
- U.S. Environmental Protection Agency. 1988. "Method TO-14: The Determination of Volatile Organic Compounds in Ambient Air Using SUMMA<sup>®</sup> Passivated Canister Sampling and Gas Chromatograph (GC) Analysis, as contained in Compendium of Methods for the Determination of Toxic Organic Compounds in Ambient Air, 2nd Supplement." Research Triangle Park, North Carolina. EPA/600/4-89/018.
- U.S. Environmental Protection Agency. 1991. Preparation Aids for the Development of Category II Quality Assurance Project Plans. Washington, D.C. EPA/600/8-91/004.
- U.S. Environmental Protection Agency. 1994. "Guidance Manual for the Preparation of Site Characterization Technology Demonstration Plans," Las Vegas, Nevada.
- Westinghouse Savannah River Company. 1992. "Assessing DNAPL Contamination, A/M-Area, Savannah River Site: Phase I Results (U)," Aiken, SC.

# Appendix A

## Analytical Method for the Operation of the SpectraTrak™ 672

Prepared by  
Viking Instruments Corporation

### 1.0 Scope and Application

The following table lists targeted analytes and detection levels used for this evaluation. The analytes are by no means limited to those listed here.

ANALYTE	DETECTION LIMIT *	ANALYTE	DETECTION LIMIT *
chloromethane	10	trichloroethene	5
vinyl chloride	10	bromodichloromethane	5
chloroethane	10	cis-1,3-dichloropropene	5
bromomethane	10	trans-1,3-dichloropropene	5
acetone	100	1,1,2-trichloroethane	5
1,1-dichloroethene	5	toluene	5
methylene chloride	5	dibromochloromethane	5
carbon disulfide	100	tetrachloroethene	5
trans-1,2-dichloroethene	5	chlorobenzene	5
1,1-dichloroethane	5	ethylbenzene	5
2-butanone	100	m+p-xylenes	5
chloroform	5	styrene	5
1,2-dichloroethane	5	1,1,2,2-tetrachloroethane	5
1,1,1-trichloroethane	5	o-xylene	5
carbon tetrachloride	5	1,3-dichlorobenzene	5
benzene	5	1,4-dichlorobenzene	5
1,2-dichloropropane	5	1,2-dichlorobenzene	5

**\* Estimated detection limits. Units depend on sample preparation:**

$\mu\text{g}/\text{kg}$	for 5 gram soil samples concentrated by purge and trap.
$\mu\text{g}/\text{L}$	for 5 mL water samples concentrated by purge and trap.
ppm	for 250 $\mu\text{L}$ of air by direct injection.
ppb	for 0.25 to 1.0 L of air concentrated onto sorbent tubes.

Note: Lower limits (ppt and lower) can be achieved with larger sample volumes or by using selected ion monitoring.

### 2.0 Summary of Method

The analytical instrumentation used for the demonstration is a Viking SpectraTrak™ 672 transportable GC/MS system with data analysis performed by the Windows-based Hewlett-Packard Chem Station software at SRS, and EnviroQuant at WAFB. A minimum of three concentration levels were analyzed and used for establishing a calibration curve. An average response factor method was used for quantitation of

samples. The instrument was calibrated for the known historical concentrations and contaminants at each site: trichloroethene and tetrachloroethene at SRS, and a portion of the EPA method 8260 compound list at WAFB (see 7.2.1 for list).

## 2.1 Gaseous samples

Gaseous samples were analyzed by collecting 250  $\mu\text{L}$  of sample from Tedlar bags and directly introducing the sample into the instrument by split/splitless injection. An external standard (ESTD) method of calibration and quantitation was utilized. The instrument was calibrated at SRS for a range of 1 to 5000 ppm(v) while at WAFB a 1 to 25 ppm(v) calibration range was used. (Note: Air samples may also be concentrated on a sorbent trap using the unit's sampling pump, then thermally desorbed for analysis. This concentration step was not necessary at either site.)

## 2.2 Liquid samples

Liquid samples were analyzed by concentrating a 5 mL volume by purge and trap, then thermally desorbing for GC/MS analysis. An internal standard (ISTD) method of calibration and quantitation was utilized with 50  $\mu\text{g/L}$  of internal standard added to each sample. The instrument was calibrated at SRS for a range of 10 to 1000  $\mu\text{g/L}$  while at WAFB a 10 to 200  $\mu\text{g/L}$  calibration range was used.

## 2.3 Soil samples

Soil samples were analyzed at SRS by extracting a portion of soil with methanol, then injecting 2  $\mu\text{L}$  of the methanol extract into the instrument. A selected ion was monitored for each compound (m/z 130 for trichloroethene and m/z 166 for tetrachloroethene). ESTD quantitation was applied to the extracted soil samples within a calibration range of 50 to 1000  $\mu\text{g/kg}$ .

The soils at WAFB were analyzed by purge and trap / thermal desorption GC/MS. ISTD quantitation was used for the soils with 50  $\mu\text{g/kg}$  of internal standards added to each sample. The calibration ranged from 10 to 200  $\mu\text{g/kg}$ .

## 3.0 Definitions

ESTD	external standard	ppb(v)	parts per billion by volume
g	gram	ppm(v)	parts per million by volume
GC/MS	gas chromatograph / mass spectrometer	ppt	parts per trillion
ISTD	internal standard	SRS	Savannah River Site
kg	kilogram	TCE	trichloroethene
L	Liter	$\mu\text{g}$	microgram
mL	milliliter	$\mu\text{L}$	microliter
PCE	tetrachloroethene (perchloroethylene)	WAFB	Wurtsmith Air Force Base

## 4.0 Interferences

Interferences can occur with excessive water vapor and with contamination. Water vapor may increase some detection levels; contamination may reside in sampling equipment which must be periodically checked; cross contamination may occur with sequential high and low concentration samples. This can be checked and eliminated by periodically analyzing reagent blanks.

## 5.0 Safety

No unusual safety practices above and beyond good laboratory practices. Knowledge of specific toxicity of chemicals utilized and how to handle chemicals is essential.

## 6.0 *Equipment and Supplies*

The analytical GC/MS system (Viking SpectraTrak™ 672), comprised of a Hewlett Packard 5972 quadrupole mass spectrometer, a temperature-programmable mini-GC, Windows-based computer system, and various inlets is further described in section 3 of the demonstration plan.

The GC column installed and used in this study is a 30 meter DB-VRX column supplied by J&W Scientific. The column was remounted on a smaller column cage supplied by Viking to fit inside of the mini-GC.

Viking's purge and trap assembly is utilized for all purge and trap operations in this study. It consists of a three-way valve, needle sparger, disposable test tube, swagelock fittings; and mounts to fit the front of the SpectraTrak™. The unit's software and plumbing system take care of the rest of the purge and trap operations.

Certified concentration standard mixtures, neat compounds, and solvents were purchased from vendors such as Supelco, Aldrich, Restek, and Ultra Scientific.

## 7.0 *Quality Control*

### 7.1 **Reagents and Standards - Savannah River Site**

**7.1.1 Gaseous standards** of trichloroethylene and tetrachloroethylene were initially prepared from neat standards purchased from Aldrich. A primary dilution was prepared by injecting 18 μL of trichloroethylene and 21 μL of tetrachloroethylene into a 1.0 L Tedlar bag at room temperature and pressure. The bag was filled to 1.0 L with ultrapure air to establish a final concentration of 5000 ppm(v) of each analyte. A 1000 ppm(v) standard was also prepared from neat standards by injecting 3.6 μL of TCE and 4.2 μL of PCE into a 1.0 L Tedlar bag. The following is an example of calculations used:

$$\text{Concentration in ppm(v) of trichloroethylene (TCE)} = \frac{22.4 \times 10^6}{(\text{dilution volume})} \frac{(T/273 \text{ K}) (760/P) (\text{TCE density}) (\text{volume TCE})}{(\text{molecular weight of TCE})}$$

where T = Absolute temperature in degrees K  
and P = Pressure in mmHg

$$5000 \text{ ppm(v)} = \frac{22.4 \times 10^6}{(1.0 \text{ L})} \frac{(298/273) (760/760) (1.465 \text{ g/mL}) (X \text{ volume of TCE})}{(131)}$$

$$X = 18 \mu\text{L of TCE injected into 1.0 L air.}$$

The bags were left to equilibrate for approximately 10 minutes before use. Further dilutions were prepared from the 5000 ppm(v) standard by taking aliquots from the 5000 ppm(v) Tedlar bag and injecting them into secondary Tedlar bags. These standards ranged from 500 ppm(v) to 1.0 ppm(v). For example:

$$5000 \text{ ppm(v)} \times 5.0 \text{ mL aliquot volume} / 1.0 \text{ L dilution volume} = 25 \text{ ppm(v) final conc.}$$

**7.1.2 Liquid standards** were prepared from liquid stock solutions purchased from Ultra Scientific and Supelco. A 1000 μg/mL solution of volatile compounds was diluted to 50 μg/mL by a 1:20 dilution in methanol. The 50 μg/mL solution was used for the purge and trap calibration in the range of 10 μg/L to 1000 μg/L. A 50 μg/mL solution of internal standards and added to each sample and standard for a final



concentration of 50  $\mu\text{g/L}$ . The internal standard 1,4-difluorobenzene was used for quantitating the trichloroethene and tetrachloroethene. The same solution of volatiles at 50  $\mu\text{g/mL}$  was diluted to concentrations of 50  $\mu\text{g/L}$  to 1000  $\mu\text{g/L}$  in methanol for direct injection / calibration for soil samples.

## 7.2 Reagents and Standards - Wurtsmith Air Force Base

**7.2.1 Gaseous standards** were prepared from liquid solutions directly injected into Tedlar bags. A 1000  $\mu\text{g/mL}$  solution of volatile compounds was used as the stock solution for each calibration standard prepared. A 5000  $\mu\text{g/mL}$  solution of each isomer of dichlorobenzene was also used. Stock solutions were purchased from Ultra Scientific and Supelco.

### Standard Compounds in Gas Mixtures

Compound Name	MW	Volume injected in 1.0 L (mL)	Stock Std. conc. ( $\mu\text{g/mL}$ )	mg/cubic Meter (or $\mu\text{g/L}$ )	PPM(v)
1,1-dichloroethene	96	0.01	1000	10	2.55
trans, 1-2-dichloroethylene	96	0.01	1000	10	2.55
1,1-dichloroethane	98	0.01	1000	10	2.50
cis-1,2-dichloroethylene	96	0.01	1000	10	2.55
benzene	78	0.01	1000	10	3.14
trichloroethene	130	0.01	1000	10	1.88
toluene	92	0.01	1000	10	2.66
tetrachloroethene	164	0.01	1000	10	1.49
chlorobenzene	112	0.01	1000	10	2.18
ethylbenzene	106	0.01	1000	10	2.31
m+p-xylenes	106	0.01	1000	10	4.62
o-xylene	106	0.01	1000	10	2.31
1,3-dichlorobenzene (m-)	146	0.001	5000	5	0.84
1,4-dichlorobenzene (p-)	146	0.001	5000	5	0.84
1,2-dichlorobenzene (o-)	146	0.001	5000	5	0.84

ppm(v) calculation:  $\text{ppm(v)} = 24.46 \text{ (mg/cubic M)} / \text{Molecular Weight}$

Standards of approximately 10 ppm(v) and 25 ppm(v) were also prepared in similar fashion.

**7.2.2 Liquid standards** were prepared from the same stock solutions as used for the gaseous standards. A 50  $\mu\text{g/mL}$  working solution was prepared from the 1000  $\mu\text{g/mL}$  stock standard by a 1:20 dilution in methanol. Volumes of 1  $\mu\text{L}$  to 20  $\mu\text{L}$  of the working solution were injected into 5.0 mL of water for calibration standards in the range of 10  $\mu\text{g/L}$  to 200  $\mu\text{g/L}$ .

Note: The calibration for liquid samples was also used for soil samples since the same analytical method was performed on both matrices.

## 8.0 Sample Collection, Preservation, and Storage

See demonstration plan.