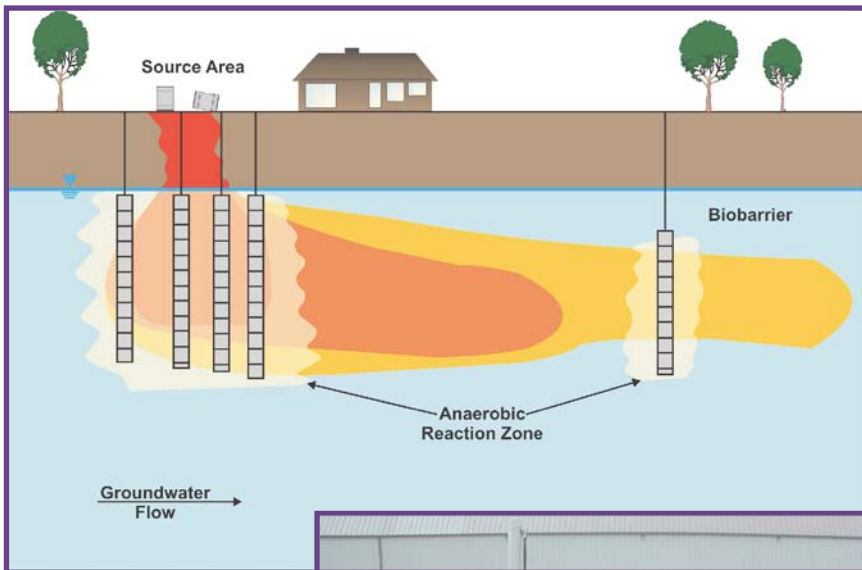


# FINAL

## Protocol for *In Situ* Bioremediation of Chlorinated Solvents Using Edible Oil



U.S. AIR FORCE

October 2007

**FINAL**

**PROTOCOL FOR *IN SITU* BIOREMEDIATION OF  
CHLORINATED SOLVENTS USING EDIBLE OIL**



**October 2007**

**Prepared for:**

**Air Force Center for Engineering and the Environmental  
Environmental Science Division  
Technology Transfer Outreach Office**

## ACKNOWLEDGEMENTS

This protocol was prepared by Solutions IES, Inc. (Solutions IES), Terra Systems, Inc. (TSI), and Parsons Infrastructure & Technology Group, Inc. (Parsons) under contract to the Air Force Center for Engineering and the Environmental (AFCEE). This document is intended to assist AFCEE and their United States Department of Defense (DoD) technology-transition partners in evaluating and applying edible oil and edible oil emulsions as a long-lasting organic substrate to enhance the *in situ* anaerobic bioremediation of chlorinated solvents in groundwater. The authors acknowledge the assistance of numerous individuals who provided management, oversight, and review services. These individuals and their affiliations are listed in Appendix A.

## **DISCLAIMER**

This protocol is a work prepared for the Technology Transfer Outreach Office of the United States Air Force Center for Engineering and the Environmental (AFCEE) by Solutions-IES, Inc. Terra Systems, Inc., Parsons Infrastructure & Technology Group, Inc., and representatives from AFCEE. In no event shall either the United States Government, Solutions-IES, Inc., Terra Systems, Inc., or Parsons Infrastructure & Technology Group, Inc. have any responsibility or liability for any consequences of any use, misuse, inability to use, or reliance upon the information contained herein; nor does these entities warrant or otherwise represent in any way the accuracy, adequacy, efficacy, or applicability of the contents hereof.

# TABLE OF CONTENTS

	Page
SECTION 1 - USING THE EDIBLE OIL PROCESS.....	1-1
1.1 Introduction .....	1-1
1.2 Intended Use of this Document .....	1-2
1.3 Following the Edible Oil Process .....	1-3
1.4 Defining Remedial Objectives .....	1-4
1.5 Enhanced Anaerobic Bioremediation of Chlorinated Solvents.....	1-6
1.6 Overview of the Edible Oil Process .....	1-14
1.6.1 Treatment System Configurations.....	1-15
1.6.1.1 Source Areas.....	1-16
1.6.1.2 Permeable Biobarriers .....	1-16
1.6.2 Edible Oil.....	1-16
1.6.3 Application Methods .....	1-18
1.6.3.1 Pure Edible Oil .....	1-18
1.6.3.2 Oil-in-Water Emulsions.....	1-19
1.6.4 Design and Implementation of Edible Oil Applications .....	1-21
SECTION 2 - PRELIMINARY SCREENING .....	2-1
2.1 Road Map for Preliminary Screening.....	2-1
2.2 Site Screening Considerations.....	2-3
2.3 Site Conditions Suitable for Edible Oil Applications.....	2-5
2.3.1 Potential for Reductive Dechlorination .....	2-6
2.3.1.1 Types of Groundwater Environments.....	2-6
2.3.1.2 Assessing the Potential for Reductive Dechlorination .....	2-6
2.3.1.3 Potential for Biogeochemical Reduction.....	2-8
2.3.2 Source Area and Plume Size .....	2-9
2.3.3 Depth to Groundwater .....	2-9
2.3.4 Heterogeneity and Hydraulic Conductivity.....	2-10
2.3.5 Groundwater Flow.....	2-10
2.3.6 Competing Electron Acceptors.....	2-11
2.3.7 pH and Alkalinity .....	2-12
2.4 Proceeding with the Edible Oil Process .....	2-12
SECTION 3 - PILOT TEST PLANNING, IMPLEMENTATION, AND MONITORING .....	3-1
3.1 Defining Pilot Test Objectives .....	3-1
3.2 Development of a Site-Specific Test Plan.....	3-2
3.3 Pilot Test Configurations.....	3-3
3.3.1 Single Well Push-Pull Injection Tests.....	3-4
3.3.1.1 Single-Stage Push-Pull Test .....	3-4
3.3.1.2 Two-Stage Push-Pull Test .....	3-6

## TABLE OF CONTENTS (Continued)

	<b>Page</b>
3.3.2 Multi-Well Injection Tests .....	3-7
3.4 Monitoring During the Injection Process .....	3-7
3.4.1 Radius of Influence Evaluation .....	3-8
3.4.1.1 Water Soluble Groundwater Tracers .....	3-8
3.4.1.2 Oil Soluble Tracers .....	3-9
3.4.1.3 Soil Analysis for Determining Substrate Distribution.....	3-10
3.4.2 Effect of Oil Injection on Formation Permeability.....	3-10
3.5 Monitoring Networks .....	3-10
3.5.1 Number and Location of Monitoring Points .....	3-11
3.5.2 Analysis of Substrate Distribution.....	3-13
3.5.3 Monitoring Frequency .....	3-14
3.6 Performance Monitoring Protocols .....	3-14
3.6.1 Contaminants and Dechlorination Products .....	3-15
3.6.2 Biogeochemistry.....	3-15
3.6.3 Indicators of Organic Carbon .....	3-15
3.6.4 Microbiological Characterization.....	3-16
3.6.5 Soil Characterization .....	3-18
3.6.6 Soil Gas .....	3-19
3.6.7 Downgradient Water Quality .....	3-19
3.7 Proceeding to Full-Scale Application.....	3-19
 SECTION 4 - DESIGN OF FULL-SCALE EDIBLE OIL APPLICATIONS.....	 4-1
4.1 Remedial Objectives and Edible Oil Configurations .....	4-1
4.1.1 Remedial Objectives.....	4-1
4.1.2 Treatment System Configurations.....	4-2
4.1.2.1 Source Areas.....	4-2
4.1.2.2 Permeable Biobarriers for Plume Treatment .....	4-3
4.2 General Design Parameters .....	4-4
4.2.1 Treatment Zone Dimensions .....	4-4
4.2.2 Amount of Oil Required for Effective Treatment .....	4-6
4.2.2.1 Site Hydrogeology and Volume of Water to be Treated .....	4-6
4.2.2.2 System Design Life.....	4-7
4.2.2.3 Hydrogen Demand.....	4-8
4.2.2.4 Additional Hydrogen Demands and Organic Carbon Released Downgradient .....	4-10
4.2.2.5 Oil Retention within the Aquifer Matrix .....	4-10
4.2.2.6 Chlorinated Solvent Partitioning into Oil .....	4-11
4.2.2.7 Summary – How Much Oil Do You Need?.....	4-13
4.2.3 Amendments.....	4-13
4.2.4 Source of Make-up Water or Chase Water.....	4-15
4.2.5 Dilution or Chase Water Volumes .....	4-15
4.2.5.1 Water Chase for Pure Oil Injection .....	4-15
4.2.5.2 Amount of Water Required During Emulsion Injection.....	4-16
4.2.6 Injection Well Spacing, Injection Intervals, and Well Design .....	4-16

## TABLE OF CONTENTS (Continued)

	<b>Page</b>
4.2.7	Additional Planning Considerations.....4-18
4.2.7.1	Oil Breakout.....4-18
4.2.7.2	Groundwater Mounding.....4-18
4.2.7.3	Effect of Oil Injection on Downgradient Water Quality .....4-18
4.2.7.4	Soil Gas Emissions .....4-19
4.3	Source Area Treatment.....4-19
4.3.1	Source Area Treatment Using Pure Edible Oil .....4-19
4.3.2	Source Area Treatment Using Edible Oil Emulsions.....4-20
4.4	Biobarriers Using Edible Oil Emulsions .....4-21
4.5	Design of Oil-in-Water Emulsions .....4-21
4.6	Cost Analysis of Design Options .....4-22
SECTION 5 - METHODS FOR IMPLEMENTING THE EDIBLE OIL PROCESS .....5-1	
5.1	Distribution and Injection of Pure Edible Oil.....5-1
5.1.1	Distribution of Pure Edible Oil in the Subsurface.....5-1
5.1.2	Procedures for Injection of Pure Edible Oil .....5-5
5.1.2.1	Injection of Pure Edible Oil Using Permanent Wells.....5-5
5.1.2.2	Pure Oil Injection through Direct-Push Points .....5-7
5.1.2.3	Injection Pressure and Flow Rate .....5-7
5.2	Injection and Distribution of Edible Oil Emulsions .....5-9
5.2.1	Preparation of Oil-in-Water Emulsions.....5-9
5.2.2	Procedures for Injection of Edible Oil Emulsions.....5-10
5.2.2.1	Injection System Setup .....5-11
5.2.2.2	Emulsion Injection Wells .....5-13
5.2.2.3	Emulsion Injection Procedures .....5-14
SECTION 6 - DATA EVALUATION AND REPORTING.....6-1	
6.1	Changes In Contaminant Concentration and Mass .....6-1
6.1.1	Partitioning of Contaminant Mass into Edible Oil.....6-2
6.1.2	Visual Techniques for Determining Contaminant Trends.....6-2
6.1.2.1	Concentration Isopleth Maps.....6-3
6.1.2.2	Concentration Versus Time and Distance Plots .....6-3
6.1.3	Chlorine Number Plots .....6-7
6.1.4	Statistical Techniques for Determining Contaminant Trends .....6-8
6.2	Changes in Groundwater Geochemistry.....6-10
6.2.1	Native Electron Acceptors.....6-12
6.2.1.1	Dissolved Oxygen.....6-12
6.2.1.2	Nitrate .....6-13
6.2.1.3	Sulfate .....6-13
6.2.2	Metabolic Byproducts and Oxidation-Reduction Potential.....6-13
6.2.2.1	Iron (II) and Manganese (II) .....6-13
6.2.2.2	Methane, Ethane, Ethene .....6-14

## TABLE OF CONTENTS (Continued)

		Page
	6.2.2.3 pH and Alkalinity .....	6-14
	6.2.2.4 Chloride .....	6-15
	6.2.2.5 Oxidation-Reduction Potential .....	6-15
	6.2.2.6 Dissolved Hydrogen .....	6-15
6.3	Biodegradation Rate Constant Calculations .....	6-17
6.4	Project Reporting.....	6-18
SECTION 7 - REFERENCES.....		7-1

### APPENDICES

Appendix A	Key Personnel	
Appendix B	Summary Table of DoD Edible Oil Applications	
Appendix C	Vendor List of Edible Oil or Related Products	
Appendix D	Properties and Behavior of Edible Oil	
Appendix E	Microbiology of Reductive Dechlorination	
Appendix F	Analytical Protocols	
Appendix G	Example Substrate Calculations	
Appendix H	Edible Oil Case Studies	
H.1	Enhanced <i>In Situ</i> Anaerobic Bioremediation of Chlorinated Solvents at the Hangar K Site, Cape Canaveral Air Force Station, Florida	
H.2	Enhanced Anaerobic Biodegradation of Trichloroethene Using Edible Oil in a Permeable Biobarrier	
H.3	Enhanced <i>In Situ</i> Anaerobic Bioremediation of Chlorinated Ethanes Using Emulsified Vegetable Oil	

### LIST OF TABLES

No.	Title	Page
1.1	Characteristics of Chlorinated Aliphatic Hydrocarbons and Dechlorination End Products .....	1-8
1.2	Source Area Treatment Versus Permeable Biobarrier Designs .....	1-21
1.3	Comparison of Injection of Pure Edible Oil Versus an Oil-In-Water Emulsion .....	1-22
2.1	Site Characteristics Suitable for the Edible Oil Process.....	2-5
3.1	Example Calculations of the Dimensions of the Injectant Distribution Zone .....	3-12
3.2	Methods to Measure Distribution of Organic Substrates .....	3-13
4.1	Stoichiometric Hydrogen Demand for Different Contaminants and Electron Acceptors.....	4-9
4.2	Observed Emulsion Retention by Sediment.....	4-11
4.3	Oil-Water Partition Coefficients ( $K_p$ ) for Pure PCE, TCE, cis-1,2-DCE, VC and Mixtures of these Materials between Water and Soybean Oil .....	4-12
4.4	Estimated Retardation Factors for Different Chlorinated Ethenes.....	4-12
4.5	Alternative Amendments for Edible Oil Emulsions or Water Chase.....	4-14
4.6	Typical Values for Dry Bulk Density, Total Porosity and Effective Porosity of Aquifer Materials .....	4-17



## TABLE OF CONTENTS (Continued)

### LIST OF TABLES (Continued)

	<b>Page</b>
5.1 Physical Properties of PCE, TCE, Soybean Oil, Corn Oil, and 50:50 Mixtures of Solvents and Edible Oil.....	5-2
5.2 Residual Saturation and Change in Hydraulic Conductivity Following Injection with Pure Soybean Oil.....	5-4
6.1 Concentrations of Chlorinated Compounds in Vegetable Oil and Groundwater in an Injection Well at the Hangar K Site, CCAFS, Florida.....	6-2
6.2 Trends in Contaminant, Electron Acceptor, Metabolic Byproduct, and Total Alkalinity Concentration during Biodegradation.....	6-11
6.3 Range of Hydrogen Concentrations for a Given Terminal Electron-Accepting Process.....	6-16

### LIST OF FIGURES

<b>No.</b>	<b>Title</b>	<b>Page</b>
1.1	Road Map for Implementation of the Edible Oil Process .....	1-5
1.2	Pathways for the Degradation of Chlorinated Ethenes.....	1-11
1.3	Pathways for the Degradation of Chlorinated Methanes.....	1-12
1.4	Pathways for the Degradation of Chlorinated Ethanes.....	1-13
1.5	Example System Configurations for Using Edible Oil to Treat Contaminated Groundwater in: (a) Source Areas and (b) Biobarriers .....	1-15
1.6	Photomicrographs of Oil-in-Water Emulsions.....	1-18
1.7	Direct Injection of Pure Edible Oil through Geoprobe® Rods Using a Grout Pump.....	1-19
1.8	Typical Oil Emulsion Injection System Layout .....	1-20
2.1	Road Map for Preliminary Screening of the Edible Oil Process.....	2-2
3.1	Changes in Chlorinated Ethenes in Untreated Control Well WL-250 and Emulsion Treated Well TS-IW-6 at OU-1, Altus AFB, Oklahoma.....	3-5
3.2	Concentrations of TOC and Total VFAs Over Time for Two Sites.....	3-16
4.1	Injection Configurations for Using Edible Oil to Treat Contaminated Groundwater in: (a) Source Areas and (b) Biobarriers .....	4-2
4.2	Dimensions Used in Calculating a Treatment Zone.....	4-5
5.1	Critical Edible Oil Thickness for Upward Migration as a NAPL from a Coarse Sand ( $r_c = 1$ millimeter) into a Fine-grained Unit.....	5-3
5.2	Variation in Hydraulic Gradient during Injection through Ottawa Sand with Three Pore Volumes of Pure Soybean Oil followed by Plain Water at Constant Flow Rate .....	5-5
5.3	Typical Injection System Layout for Pure Edible Oil, Naval Support Activity Mid-South, Tennessee.....	5-6
5.4	Pure Edible Oil Injection through Geoprobe® Rods Using a Grout Pump.....	5-7

## TABLE OF CONTENTS (Continued)

### LIST OF FIGURES (Continued)

	<b>Page</b>
5.5 Photomicrographs of Emulsions: (a) Produced in the Field with a High Shear Mixer and (b) a Pre-Mixed Emulsion .....	5-10
5.6 Typical Injection System Using a Field Prepared Emulsion, Altus AFB, Oklahoma .....	5-11
5.7 System Used to Prepare and Inject Soybean Oil-Lecithin Emulsion at Edwards Air Force Base, California .....	5-12
5.8 Setup of Automatic Metering System for Dilution of Concentrated Emulsion Product .....	5-13
5.9 Typical Well Head Configuration .....	5-14
5.10 Injection System Manifold Showing Separate Control Valve and Flow Totalizer for Each Injection Well.....	5-15
5.11 Proportional Feed System for a 10-Line Injection System .....	5-15
6.1 Concentrations of TCE in Groundwater Prior to Injection and 3 Years after Injection at Site SS-015, Travis AFB, California.....	6-4
6.2 Changes in Chlorinated Ethenes Over Time Due to Sequential Reductive Dechlorination.....	6-5
6.3 Changes in Total Molar Concentration (PCE + TCE + DCE + VC + Ethene) Over Distance along a Central Flow Path through a Treatment Zone at CCAFS, Florida.....	6-6
6.4 Changes in Concentration of Chlorinated Ethenes, Ethene, and Methane Over Time at Well MP04, Travis AFB, California.....	6-6
6.5 Changes to Molar Concentrations of Chlorinated Compounds in Groundwater after Injection of Emulsified Oil Substrate .....	6-7
6.6 Relative Hydraulic Conductivity, TOC, Sulfate, and Chlorine Numbers throughout Altus AFB Pilot Test Plot.....	6-9
6.7 Changes in Select Geochemical Indicator Parameters Over Time Due to Anaerobic Biodegradation of Organic Carbon.....	6-12
6.8 Example Table of Contents .....	6-20

## LIST OF ACRONYMS AND ABBREVIATIONS

$\mu\text{g/L}$	micrograms per liter
$\mu\text{moles/L}$	micromoles per liter
$^{\circ}\text{C}$	degrees Celsius
AFCEE	Air Force Center for Engineering and the Environment
AFB	Air Force Base
AMIBA	Aqueous Mineral Intrinsic Bioremediation Assessment
atm	atmosphere
$\text{atm}\cdot\text{m}^3/\text{mol}$	atmosphere-cubic meter per mole
bgs	below ground surface
BOD	biochemical oxygen demand
CA	chloroethane
CaO	quicklime
CaO/MgO	dolomitic quicklime
CAH	chlorinated aliphatic hydrocarbon
CCAFS	Cape Canaveral Air Force Station
CERCLA	Comprehensive Environmental Response, Compensation, and Liability Act
$\text{CH}_4$	methane
Cl#	chlorine number
cm/sec	centimeters per second
$\text{CO}_2$	carbon dioxide
COD	chemical oxygen demand
CPT	cone penetrometer testing
CSIA	compound-specific isotope analysis
CSM	conceptual site model
CT	carbon tetrachloride
DCA	dichloroethane
DCE	dichloroethene or dichloroethylene
DGGE	denaturing gradient gel electrophoresis
DNAPL	dense nonaqueous-phase liquid
DO	dissolved oxygen
DOC	dissolved organic carbon
DoD	Department of Defense
DQO	data quality objective
dynes/cm	dynes per centimeter
EEO	emulsified edible oil
Eh	measure of oxidation-reduction potential
ESO	emulsified soybean oil
ESTCP	Environmental Security Technology Certification Program
EVO	emulsified vegetable oil
Fe(II)	ferrous iron
Fe(III)	ferric iron
$\text{Fe}^0$	zero valent iron
FeS	iron mono-sulfide
$\text{FeS}_2$	iron disulfide
ft/day	feet per day
ft/yr	feet per year

g/cm <sup>3</sup>	grams per cubic centimeter
g/g	grams per gram
g/ml	grams per milliliter
g/mol	grams per mole
GMO	glycerol monooleate
GRAS	generally recognized as safe
H <sub>2</sub>	molecular hydrogen
HLB	hydrophile/lipophile balance
HRC <sup>®</sup>	hydrogen release compound
ISEO	Institute of Shortening and Edible Oils
ITRC	Interstate Technology Regulatory Council
K	permeability
K <sub>oc</sub>	octanol/carbon coefficient
K <sub>ow</sub>	octanol-water partition coefficient
K <sub>p</sub>	oil-water partition coefficient
K <sub>s</sub> (H <sub>2</sub> )	Monod half-saturation constant (for hydrogen)
lb/ft <sup>3</sup>	pounds per cubic foot
LIF	laser-induced fluorescence
m <sup>2</sup>	square meters
m/day	meters per day
m <sup>3</sup> /day	meters cubed per day
m/s <sup>2</sup>	meters per second squared
MAROS	Monitoring and Remediation Optimization System
MBT	molecular biological tools
MCL	maximum contaminant level
Mg(OH)	magnesium hydroxide
mg/kg	milligrams per kilogram
mg/L	milligrams per liter
ml/cm <sup>3</sup>	milliliters per cubic centimeter
ml/g	milliliters per gram
mm hg	millimeters of mercury
mm <sup>2</sup> /s	milliliters squared per second
Mn(II)	manganese II
Mn(IV)	manganese IV
MNA	monitored natural attenuation
mV	millivolts
n <sub>e</sub>	effective porosity
NaBr	sodium bromide
NaHCO <sub>3</sub>	sodium bicarbonate
NaOH	caustic hydroxide
NAPL	nonaqueous-phase liquid
NAVFAC	Naval Facilities Engineering Command
ND	nondetect
NFESC	Naval Facilities Engineering Service Center
nM	nanomolar or nanomoles
nmol/L	nanomoles per liter
O&M	operations and maintenance
ORP	oxidation-reduction potential (also redox)
Parsons	Parsons Infrastructure & Technology Group, Inc.

Pc	capillary pressure
PCA	perchloroethane, or tetrachloroethane
PCB	polychlorinated biphenyl
PCE	perchloroethene, or tetrachloroethene
PCR	polymerase chain reaction
PLFA	phospholipid fatty acid
POL	petroleum, oil and lubricant
ppm	parts per million
psi	pounds per square inch
PV	pore volume
PVC	polyvinyl chloride
Q	groundwater discharge
RDX	hexahydro-1,3,5-trinitro-1,3,5-triazine
redox	oxidation-reduction
ROI	radius of influence
RTDF	Remediation Technologies Development Forum
SERDP	Strategic Environmental Research and Development Program
Solutions IES	Solutions IES, Inc.
TCA	trichloroethane
TCE	trichloroethene or trichloroethylene
TDS	total dissolved solids
TEAP	terminal electron accepting process
TIC	total inorganic carbon
TNT	trinitrotoluene
TOC	total organic carbon
TPH	total petroleum hydrocarbon
T-RFLP	terminal restriction fragment length polymorphism
TSI	Terra Systems, Inc.
UIC	underground injection control
USACE	United States Army Corps of Engineers
USEPA	United States Environmental Protection Agency
VC	vinyl chloride
VegOil	vegetable oil
VFA	volatile fatty acid
VOC	volatile organic compound
VS	volatile solids
wt/wt	weight per weight

# SECTION 1

## USING THE EDIBLE OIL PROCESS

### 1.1 INTRODUCTION

Management of groundwater contaminated with chlorinated solvents is one of the Department of Defense's (DoD's) greatest environmental challenges. A variety of chlorinated solvents have been used for years in both the military and commercial sectors for cleaning and degreasing many products and equipment ranging from aircraft engines, automobile and truck parts, electronic components and clothing. The number of DoD sites contaminated with chlorinated solvents is likely second only to petroleum, oil, and lubricant (POL) sites.

*The Edible Oil Process is part of an initiative by the Air Force Center for Engineering and the Environment to develop and demonstrate new technologies for the remediation of chlorinated solvents in groundwater.*

Because of their physical and chemical properties, most chlorinated solvents are relatively recalcitrant in the subsurface, are more difficult to access once they are in the ground, and take longer to remediate. Consequently, the cost of remediating chlorinated solvents sites may significantly exceed the cost of remediating POL sites.

Specifically, if chlorinated solvents are released to the subsurface as a dense non-aqueous phase liquid (DNAPL), the density of the DNAPL relative to water will lead to a complex distribution of the contaminant in the vadose and saturated zones (Schwille, 1988; Kueper, *et al.*, 1993). Chlorinated solvents are oxidized man-made compounds, which makes them susceptible to degradation by reductive processes under anaerobic conditions, either ambient or enhanced. In contrast, POL contaminants are derived from naturally-occurring hydrocarbons that are lighter than water and are degradable under a wide spectrum of geochemical conditions ranging from highly aerobic to highly anaerobic. Thus, as compared to POL contamination, the *in situ* treatment of chlorinated solvents often requires a more sophisticated approach to effective delivery of remedial reagents and to manipulate and control subsurface geochemical conditions.

To address this problem, the Air Force Center for Engineering and the Environment (AFCEE) in Brooks City-Base, Texas, undertook several initiatives. First, AFCEE and its technology partners developed and demonstrated new remediation technologies at Air Force bases nationwide. Second, AFCEE transferred the technologies to the bases, resulting in implementation and on-site evaluation of many innovative cleanup approaches. And finally, based on this experience, AFCEE supported the development of several documents and tools to assist environmental managers with their decision-making process when faced with

subsurface impacts from chlorinated solvents at their base. Two documents are relevant here to the discussion of this protocol.

The first document, titled “*Principles and Practices of Enhanced Anaerobic Bioremediation of Chlorinated Solvents*” (*i.e.*, the Principles and Practices document) was published in cooperation with the Naval Facilities Engineering Service Center (NFESC) and the Environmental Security Technology Certification Program (ESTCP) in August 2004 (AFCEE *et al.*, 2004). The Principles and Practices document describes the scientific basis of enhanced anaerobic bioremediation of chlorinated solvents and summarizes relevant site selection, design, and performance criteria for various engineered approaches to stimulate and enhance the *in situ* biodegradation of chlorinated solvents in groundwater. It is not intended to be a protocol to implement enhanced *in situ* bioremediation, but rather an overview of the technology.

The document in hand, titled “*Protocol for In Situ Bioremediation of Chlorinated Solvents using Edible Oil*” (*i.e.*, the Edible Oil Protocol), follows directly from the content of the Principles and Practices document. As described in the Principles and Practices document, there are a variety of methods for addition of an organic substrate to the subsurface to stimulate *in situ* anaerobic bioremediation. In all of these processes, the organic substrate is fermented to hydrogen and low molecular weight organic acids (*i.e.*, electron donors) to support anaerobic reductive dechlorination as the primary process for degrading chlorinated solvents in groundwater. This particular protocol focuses on the application of pure edible oil and edible oil emulsions to provide a long-lasting organic substrate for enhanced *in situ* anaerobic bioremediation of chlorinated solvents.

## **1.2 INTENDED USE OF THIS DOCUMENT**

The addition of pure liquid edible oil and edible oil emulsions, referred to as the edible oil process, has been used to stimulate the *in situ* anaerobic biodegradation of chlorinated solvents and related contaminants at commercial, industrial and military sites throughout the United States. The protocol presented in this document is intended to assist base managers and project engineers in 1) determining if the edible oil process is appropriate for their site; 2) designing and implementing an edible oil engineered system; and 3) evaluating and optimizing remedial performance over time. This protocol also provides background information on the development and scientific basis of this technology.

The intended audience for this document is DoD personnel and their contractors, scientists, consultants, regulatory personnel, and others charged with remediating groundwater contaminated with chlorinated compounds and other contaminants that are susceptible to anaerobic degradation processes. This protocol is intended for use within the established regulatory framework appropriate for selection of a remedy at a particular hazardous waste site.

It is not the intent of this protocol to prescribe a course of action, including site characterization, in support of all possible remedial technologies. Instead, this protocol is another remediation tool similar to other AFCEE Technology Transfer protocols for natural attenuation of chlorinated solvents (developed with and published by the United States Environmental Protection Agency [USEPA], 1998), natural attenuation of fuel hydrocarbons (Wiedemeier *et al.*, 1995), bioventing (Hinchee *et al.*, 1992) or free-product recovery protocol (AFCEE, 1995). This protocol allows practitioners to gain an in-depth understanding of the

edible oil process, decide how best to apply it, and then design and implement the technology for site remediation. The protocol illustrates how the hydrogeological, biogeochemical, and contaminant data collected as part of the site characterization are critical to the feasibility assessment and design of an edible oil application.

This document describes 1) development of the edible oil process and its effectiveness for stimulating biodegradation of chlorinated solvents, 2) site conditions that should be evaluated when considering the use of the edible oil process, 3) various configurations that can be applied, 4) hydrogeological and engineering considerations for developing an injection layout, 5) methods for applying the substrate to the subsurface, 6) methods to measure and evaluate multiple lines of contaminant, biogeochemical, and microbial parameters, and 7) methods to evaluate and optimize remedial performance over time. Some information in this protocol overlaps material discussed in greater detail in the Principles and Practices document. Wherever possible, extensive repetition has been minimized by referring to the Principles and Practices document. However, sufficient information is retained so that the reader of this protocol can understand the background of the edible oil process without reading the Principles and Practices document.

Readers of this protocol should also note that the procedures and applications of edible oil for the anaerobic bioremediation of chlorinated solvents are applicable to numerous other contaminants subject to anaerobic biodegradation processes such as nitrates, perchlorate, and energetics (*e.g.*, hexahydro-1,3,5-trinitro-1,3,5-triazine [RDX] or trinitrotoluene [TNT]). In addition, AFCEE is investigating the natural and enhanced biogeochemical reduction of chlorinated solvents as an extension of its “*Aqueous Mineral Intrinsic Bioremediation Assessment (AMIBA) Protocol*” (AFCEE, 2000a). AFCEE field applications have demonstrated the ability of edible oil, lactate, and organic mulch to promote the formation of reactive iron sulfide minerals and the resultant abiotic dechlorination of chlorinated solvents.

### **1.3 FOLLOWING THE EDIBLE OIL PROCESS**

The edible oil process can be a powerful tool for remediating groundwater contaminated with chlorinated solvents in groundwater. Section 1 of this document provides an overview of the edible oil process. Subsequent sections in this protocol provide greater detail into the scientific and engineering background of the technology. These sections (listed below) should be used to gain more in-depth understanding of one or more areas of particular interest to the reader.

- **Section 2** provides procedures for preliminary screening and determining the suitability of a site for the edible oil process.
- **Section 3** describes the steps required for planning and implementation of an edible oil pilot test.
- **Section 4** describes planning and detailed design of a full-scale edible oil remedy.
- **Section 5** describes the field methods used to implement an edible oil application.
- **Section 6** discusses data evaluation and reporting.
- **Section 7** presents the references used in preparing this document.

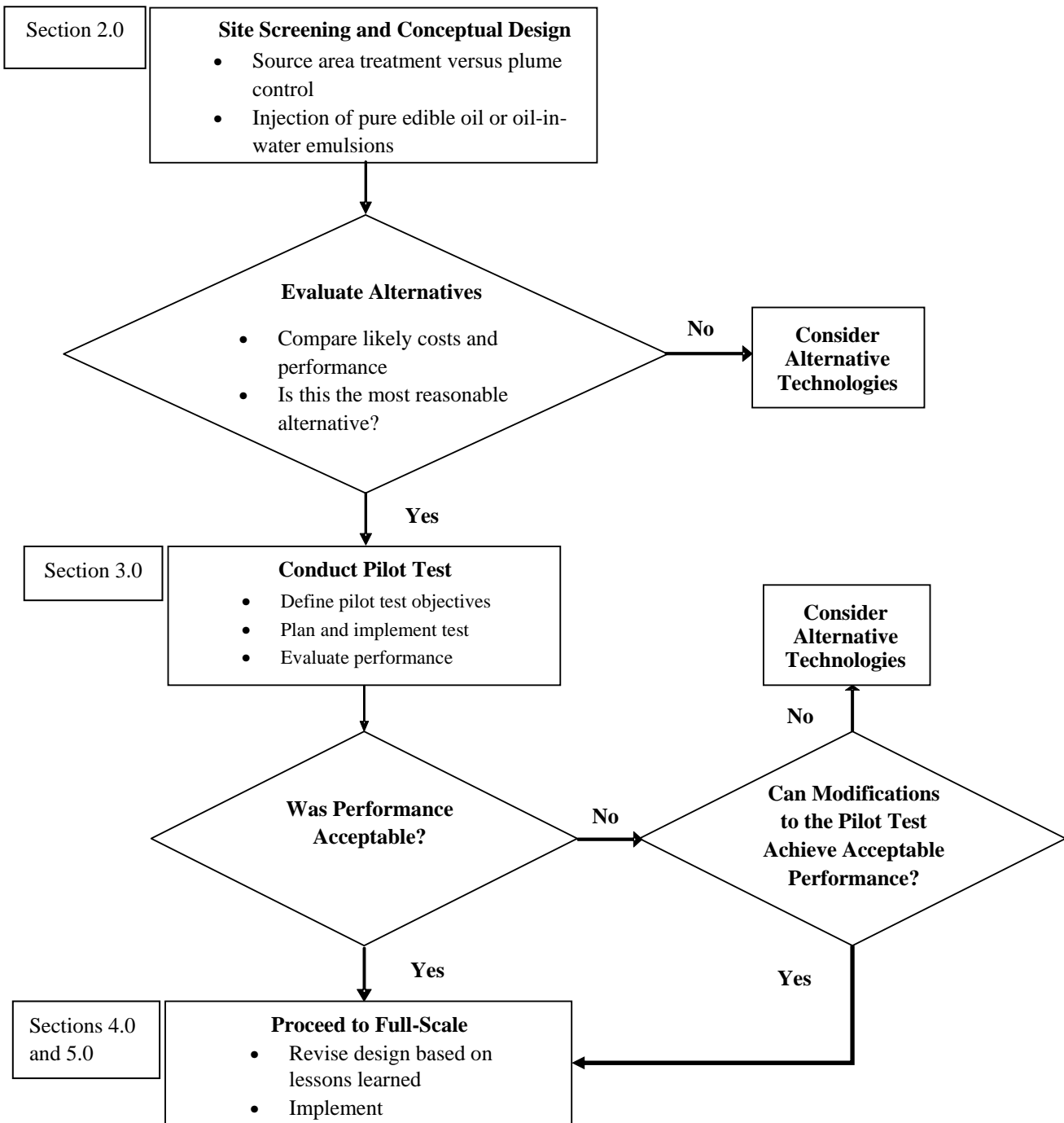


- **Appendix A** contains a list of key project members in the development of this protocol document.
- **Appendix B** contains a summary table listing DoD edible oil applications that have been implemented as of the publication of this document.
- **Appendix C** contains a list of vendors that provide edible oil substrates or products closely related to edible oil.
- **Appendix D** discusses the impact of edible oil on contaminant transport and fate. It includes information on the chemical, physical, and biological properties of edible oil and oil-in-water emulsions. In addition, Appendix D presents information on the injection and distribution of edible oil in the subsurface including background information on the subsurface transport of pure edible oil and oil-in-water emulsions.
- **Appendix E** contains additional background information on the microbiology of reductive dechlorination.
- **Appendix F** presents analytical protocols useful for preparing a sampling and analysis plan.
- **Appendix G** includes an example spreadsheet that may be used to determine the amount of edible oil to use for a given application.
- **Appendix H** provides case studies with data, techniques, and performance results from two AFCEE Technology Transfer field test sites for chlorinated ethenes, and one application for chlorinated ethenes at an industrial site.

A decision to select enhanced *in situ* bioremediation as a remedial alternative should be site-specific within the context of engineering feasibility and cost-effectiveness in relation to other technologies. Project personnel should conduct a preliminary screening (**Section 2**) to evaluate whether this approach is appropriate for their site. Once this screening is complete, a preliminary conceptual design should be developed for the site and compared against other alternatives. If appropriate, a pilot test (**Section 3**) may be conducted to evaluate the performance of the edible oil process at the site. Pilot test monitoring results should then be evaluated to determine if performance is acceptable and to determine the optimal approach for a full-scale application (**Section 4**). Methods to implement the edible oil process are described in **Section 5**. **Figure 1.1** shows a road map that site managers can follow to develop remedial designs and to implement the edible oil process at their site.

#### **1.4 DEFINING REMEDIAL OBJECTIVES**

The edible oil process is a flexible technology that can be used in a variety of different configurations to treat contaminated aquifers, including source area treatment and biobarriers. Potential benefits of this process include reduced source longevity, reduced contaminant mass discharge, enhancement of ongoing natural attenuation, and/or control of dissolved plume migration. The desired benefits of using this technology will influence the injection system layout and the method used to inject the oil.



**Figure 1.1 Road Map for Implementation of the Edible Oil Process**

Before planning an edible oil project, site managers should carefully define the remediation system objectives including compliance standards and remedial endpoints. The ability of enhanced *in situ* anaerobic bioremediation to achieve drinking water maximum contaminant levels (MCLs) has been demonstrated in some settings, but may not be possible at all sites. The use of less stringent, risk-based remedial goals may be more appropriate and achievable than default drinking water standards. Enhanced bioremediation may be limited in its ability to treat complex DNAPL source zone areas due to many of the same factors (*e.g.*, mass transfer limitations or heterogeneity) that affect conventional technologies. However, there are practitioners who are making modifications and beginning to address DNAPL sites with enhanced *in situ* anaerobic bioremediation.

Typical remediation objectives that the edible oil process can be used to address include the following:

- Destruction of contaminant mass in source zones.
- Reduction of contaminant concentrations in a dissolved plume.
- Reduction of mass discharge from a source zone or across a containment boundary.
- Cost-effective and continuous treatment over relatively long remediation timeframes.
- Enhancement of already occurring natural attenuation.
- As a polishing step after other engineered remedies such as thermal desorption or electrical resistivity heating.

Performance objectives based on dissolved contaminant concentrations alone should be used with caution. A significant amount (usually the majority) of contaminant mass in an aquifer system may be present as DNAPL or sorbed to the aquifer matrix. Due to the effects of dissolution and desorption of this contaminant mass, aqueous-phase concentrations alone may not accurately reflect the amount of mass being destroyed if there is continued mass transfer from DNAPL or sorbed mass to the aqueous phase. Also, consideration should be placed on the effects of the treatment process on secondary water quality ([Section 4](#)). This consideration is especially important at sites in close proximity to areas of surface water discharge and sites where arsenic and other redox-sensitive metals are naturally high because a net reduction in risk may not be achieved.

Once remedial objectives are established, the potential for applying the edible oil process at a site must be evaluated by preliminary screening. Not all sites will be suitable for applying the technology. [Section 2](#) describes the site conditions under which the edible oil process can be applied with a reasonable certainty of success. The following sections describe the scientific basis for anaerobic degradation of chlorinated solvents, and an overview of the edible oil process.

## **1.5 ENHANCED ANAEROBIC BIOREMEDIATION OF CHLORINATED SOLVENTS**

The most common chlorinated solvents released to the environment include tetrachloroethene (PCE, or perchloroethene), trichloroethene (TCE), 1,1,1-trichloroethane

(1,1,1-TCA), 1,2-dichloroethane (1,2-DCA), and carbon tetrachloride (CT). These chlorinated solvents and their chlorinated degradation products fall into the categories of chloroethenes, chloroethanes and chloromethanes. Collectively, these compounds are referred to as chlorinated aliphatic hydrocarbons (CAHs). In general, the more highly chlorinated the CAH, the more oxidized the CAH is and the more susceptible it is to anaerobic or reductive degradation mechanisms. The physical and chemical properties of chloroethenes, chloroethanes, and chloromethanes are listed in [Table 1.1](#).

Less chlorinated compounds and/or dechlorination products such as dichloroethene (DCE) isomers, DCA isomers, vinyl chloride (VC), and chloroethane (CA) are “cross-over” compounds in that they are also susceptible to oxidation reactions. This protocol is aimed at enhancing the anaerobic treatment of more chlorinated CAH parent compounds and their dechlorination products, but also provides practical guidance on how to evaluate other important removal mechanisms such as oxidation or abiotic reactions that can result in effective treatment throughout a larger *in situ* treatment zone.

Many CAHs can be cost-effectively degraded *in situ* by providing a source of biodegradable organic substrate. The application of enhanced *in situ* anaerobic bioremediation is covered in detail in the Principles and Practices document. As stated,

“Site-specific conditions must be reviewed prior to selecting enhanced anaerobic bioremediation as a remedial alternative. The technology is not effective unless the contaminants are anaerobically biodegradable, strongly reducing conditions can be generated, a microbial community capable of driving the process is present or can be introduced, and an organic substrate can be successfully distributed in the subsurface.”

In practice, the added organic substrates are first fermented to molecular hydrogen (H<sub>2</sub>) and low-molecular weight fatty acids. These short-chain molecules (such as acetate, lactate, propionate, and butyrate) in turn provide carbon and energy to the microorganisms which facilitate reductive dechlorination. In the reductive dechlorination process, microorganisms sequentially replace chlorine atoms with hydrogen forming more reduced dechlorination products. For example, the chlorinated ethenes are transformed sequentially from PCE to TCE to DCE to VC to ethene. If the microorganisms are able to obtain metabolically useful energy from reductive dechlorination, this process is referred to as dehalorespiration or halo-respiration (USEPA, 2000).

Other degradation processes may also occur. In some cases reductive dechlorination may be cometabolic, in which a CAH compound is reduced by an enzyme or co-factor produced during microbial metabolism of another compound in an anaerobic environment. In this case, biodegradation of the chlorinated compound does not yield any energy or benefit the growth of the microbe mediating the reaction (USEPA, 2000). Anaerobic oxidation is a biologically-mediated reaction in which less chlorinated CAHs, such as *cis*-1,2-DCE and VC, are directly oxidized to carbon dioxide, water, and chloride. This reaction has been documented to occur under iron- and manganese-reducing conditions (Bradley and Chappelle, 1996 and 1997; Bradley *et al.*, 1998a and 1998b).

**Table 1.1**  
**Characteristics of Chlorinated Aliphatic Hydrocarbons and Dechlorination End Products**

Compound	Molecular Formula	Molecular Weight (g/mol) <sup>a/</sup>	Density (g/mL @ approx. 20 to 25 °C) <sup>b/</sup>	Henry's Law Constant (atm·m <sup>3</sup> /mol) <sup>c/</sup>	Solubility (mg/L @ approx. 20 to 25 °C) <sup>d/</sup>	Vapor Pressure (mm Hg @ 20 °C) <sup>e/</sup>	Octanol/Water Partition Coefficient (log K <sub>ow</sub> ) <sup>f/</sup>	Octanol/Carbon Partition Coefficient (log K <sub>oc</sub> ) <sup>g/</sup>
<b>Chloroethenes</b>								
Tetrachloroethene (PCE)	C <sub>2</sub> Cl <sub>4</sub>	165.8 (1)	1.62 (1)	0.0132 (2)	150 (3)	14.0 (3)	2.53 (4)	2.42 (5)
Trichloroethene (TCE)	C <sub>2</sub> HCl <sub>3</sub>	131.4 (1)	1.46 (1)	0.0072 (2)	1,100 (3)	60.0 (3)	2.42 (4)	2.03 (5)
<i>cis</i> -1,2- Dichloroethene ( <i>cis</i> -1,2-DCE)	C <sub>2</sub> H <sub>2</sub> Cl <sub>2</sub>	96.94 (1)	1.28 (1)	0.0030 (2)	3,500 (3)	200 (6)	0.70	1.65 (7)
<i>trans</i> -1,2-Dichloroethene ( <i>trans</i> -1,2-DCE)	C <sub>2</sub> H <sub>2</sub> Cl <sub>2</sub>	96.94 (1)	1.26 (1)	0.0073 (2)	6,300 (4)	340 (6)	2.06 (7)	1.77 (5)
1,1-Dichloroethene (1,1-DCE)	C <sub>2</sub> H <sub>2</sub> Cl <sub>2</sub>	96.94 (1)	1.22 (1)	0.021 (2)	2,250 (5)	500 (3)	2.13 (4)	1.81 (5)
Vinyl Chloride (VC)	C <sub>2</sub> H <sub>3</sub> Cl	62.51 (1)	Gas	0.218 (2)	1,100 (3)	2,660 (3)	0.60 (4)	1.23 (5)
Ethene	C <sub>2</sub> H <sub>4</sub>	28.05 (1)	Gas	8.60 (7)	131 (7)	30,800 (7)	1.13 (8)	2.48 (7)
Acetylene	C <sub>2</sub> H <sub>2</sub>	26.04 (10)	Gas	0.0217 (10)	1,200 (10)	40,400 (10)	0.37 (10)	NA
<b>Chloroethanes</b>								
1,1,1,2-Tetrachloroethane (1,1,1,2-TCA)	C <sub>2</sub> H <sub>2</sub> Cl <sub>4</sub>	167.85 (1)	1.553 (10)	0.0025 (10)	1,070 (10)	12 (10)	2.93 (10)	NA
1,1,2,2-Tetrachloroethane (1,1,2,2-TCA)	C <sub>2</sub> H <sub>2</sub> Cl <sub>4</sub>	167.85 (1)	1.595 (1)	0.00038 (4)	2,962 (6)	5.0 (3)	2.56 (4)	2.07 (4)
1,1,1-Trichloroethane (1,1,1-TCA)	C <sub>2</sub> H <sub>3</sub> Cl <sub>3</sub>	133.4 (1)	1.34 (1)	0.0133 (2)	4,400 (3)	100 (3)	2.47 (4)	2.02 (5)
1,1,2-Trichloroethane (1,1,2-TCA)	C <sub>2</sub> H <sub>3</sub> Cl <sub>3</sub>	133.4 (1)	1.44 (1)	0.0012 (7)	4,500 (3)	19 (3)	2.18 (4)	1.75 (5)
1,1-Dichloroethane (1,1-DCA)	C <sub>2</sub> H <sub>4</sub> Cl <sub>2</sub>	98.96 (1)	1.18 (1)	0.0043 (2)	5,500 (3)	180 (3)	1.78 (4)	1.48 (5)
1,2-Dichloroethane (1,2-DCA)	C <sub>2</sub> H <sub>4</sub> Cl <sub>2</sub>	98.96 (1)	1.24 (1)	0.00098 (6)	8,690 (3)	61 (3)	1.48 (4)	1.28 (5)
Chloroethane (CA)	C <sub>2</sub> H <sub>5</sub> Cl	64.51 (1)	Gas	0.0094 (2)	5,740 (3)	1,010 (3)	1.43 (4)	1.42 (7)
Ethane	C <sub>2</sub> H <sub>6</sub>	30.07 (1)	Gas	19.2 (7)	60.4 (3)	29,300 (3)	1.81 (8)	2.66 (7)

(continued)

**Table 1.1 (concluded)**  
**Characteristics of Chlorinated Aliphatic Hydrocarbons and Dechlorination End Products**

Compound	Molecular Formula	Molecular Weight (g/mol) <sup>a/</sup>	Density (g/mL @ approx. 20 to 25 °C) <sup>b/</sup>	Henry's Law Constant (atm-m <sup>3</sup> /mol) <sup>c/</sup>	Solubility (mg/L @ approx. 20 to 25 °C) <sup>d/</sup>	Vapor Pressure (mm Hg @ 20 °C) <sup>e/</sup>	Octanol/Water Partition Coefficient (log Kow) <sup>f/</sup>	Octanol/Carbon Partition Coefficient (log Koc) <sup>g/</sup>
<b>Chloromethanes</b>								
Tetrachloromethane/ Carbon Tetrachloride (CT)	CCl <sub>4</sub>	153.8 (1)	1.58 (1)	0.0232 (4)	786 (4)	90 (3)	2.73 (4)	2.62 (4)
Trichloromethane/ Chloroform (CF)	CHCl <sub>3</sub>	119.4 (1)	1.48 (1)	0.00367 (2)	8,000 (3)	160 (3)	3.98 (4)	1.45 (9)
Dichloromethane (DCM)/ Methylene Chloride (MC)	CH <sub>2</sub> Cl <sub>2</sub>	84.93 (1)	1.33 (1)	0.00244 (4)	19,400 (4)	380 (4)	1.25 (4)	1.44 (4)
Chloromethane (CM)/ Methyl Chloride	CH <sub>3</sub> Cl <sub>1</sub>	50.48 (4)	Gas	0.00882 (2)	6,500 (4)	4,310 (4)	0.91 (4)	1.40 (4)
Methane	CH <sub>4</sub>	16.04 (1)	Gas	18.3 (7)	24 (3)	20,800 (7)	1.09 (8)	2.88 (7)

<sup>a/</sup> g/mol = grams per mole.

<sup>b/</sup> g/ml = grams per milliliter; °C = degrees Celsius.

<sup>c/</sup> atm-m<sup>3</sup>/mol = atmospheres-cubic meter per mole.

<sup>d/</sup> mg/L = milligrams per liter.

<sup>e/</sup> mm Hg = vapor pressure measured as millimeters of mercury.

<sup>f/</sup> log Kow = log of octanol/water partition coefficient (dissolution coefficient).

<sup>g/</sup> log Koc = log of octanol/carbon coefficient (soil sorption coefficient).

References:

- (1) Weast, R.C., M.J. Astle, and W.H. Beyer (eds.). 1989. *CRC Handbook of Chemistry and Physics*. 75th ed. Boca Raton, FL: CRC Press. 75th ed.
- (2) Gossett, J.M. 1987. Measurement of Henry's Law Constants for C1 and C2 Chlorinated Hydrocarbons. *Environmental Science & Technology*, Vol. 21(2):202-208.
- (3) Verschueren, K. 1983. *Handbook of Environmental Data on Organic Chemicals*. 2nd ed. New York: Van Nostrand Reinhold.
- (4) Montgomery, J.H. 1996. *Groundwater Chemicals Desk Reference*. 2nd ed. Chelsea, MI: Lewis.
- (5) Montgomery, J.H., and L.M. Welkom. 1990. *Groundwater Chemicals Desk Reference*. Chelsea, MI: Lewis.
- (6) Howard, P.H., G.W. Sage, W.F. Jarvis, and D.A. Gray. 1990. *Handbook of Environmental Fate and Exposure Data for Organic Chemicals, Vol. II – Solvents*. Chelsea, MI: Lewis.
- (7) Estimated using Lyman, W.J., W.F. Reehl, and D.H. Rosenblatt. 1990. *Handbook of Chemical Property Estimation Methods*. Washington, DC: American Chemical Society.
- (8) Hansch, C, A. Leo, and D. Hoekman. 1995. *Exploring QSAR – Hydrophobic, Electronic, and Steric Constants*. Washington, DC: American Chemical Society.
- (9) Grathwohl, P. 1990. Influence of Organic Matter from Soils and Sediments from Various Origins on the Sorption of Some Chlorinated Aliphatic Hydrocarbons. *Environmental Science & Technology*, Vol. 24:1687-1693.
- (10) Syracuse Research Corporation (SRC) Physical Properties on-line database (various sources).

Abiotic or chemical dechlorination may occur where a CAH compound is reduced by a reactive compound that is not directly associated with biological activity. For example, this is the reaction targeted using zero-valent iron ( $\text{Fe}^0$ ) in permeable reactive barriers. Note that addition of an organic substrate and creation of an anaerobic environment may create reactive minerals such as iron-monosulfides that can degrade CAHs (*e.g.*, Butler and Hayes, 1999). In this case the overall degradation pathway is referred to as ***biogeochemical reduction*** because the reactive mineral is formed in part due to biological processes. Other abiotic reactions that may be of significance include dehydrochlorination of 1,1,1-TCA to 1,1-DCE or hydrolysis of CA. Examples of the degradation pathways for chloroethenes, chloromethanes, and chloroethanes are shown in [Figure 1.2](#), [Figure 1.3](#), and [Figure 1.4](#), respectively (figures provided courtesy of Geosyntec Consultants).

Other groundwater contaminants also subject to anaerobic degradation processes include the following types of chemicals:

- Oxidizers such as perchlorate and chlorate;
- Explosive and ordnance compounds (*e.g.*, TNT or RDX);
- Dissolved metals (*e.g.*, hexavalent chromium);
- Nitrate and sulfate; and
- *Potentially* for chlorobenzenes, chlorinated pesticides (*e.g.*, chlordane), polychlorinated biphenyls (PCBs), and chlorinated cyclic hydrocarbons (*e.g.*, pentachlorophenol).

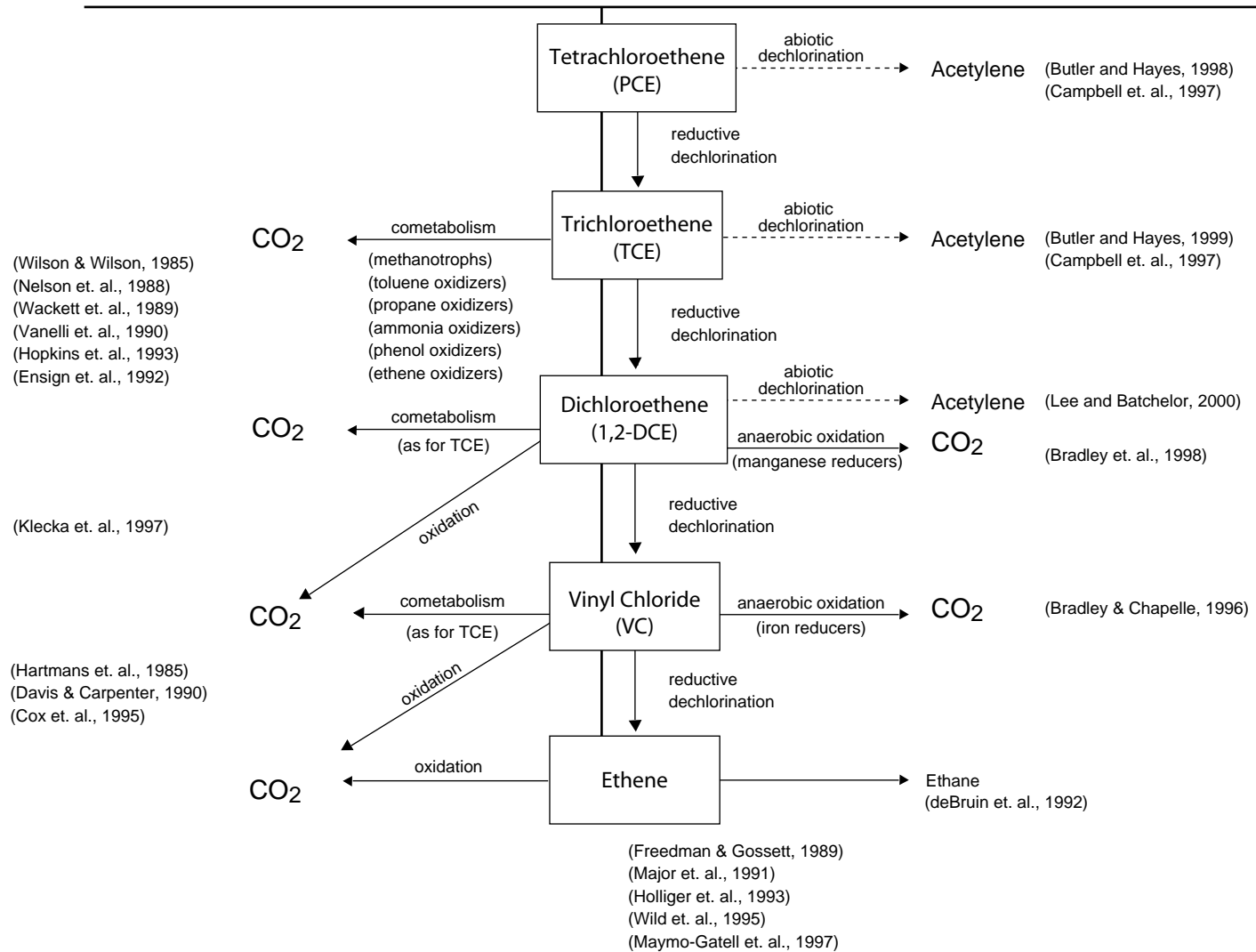
A variety of different organic substrates have been used to generate hydrogen and stimulate reductive dechlorination. The substrates can be broadly categorized into four types: soluble substrates (*e.g.*, sodium lactate and molasses), slow-release substrates (*e.g.*, hydrogen release compound [HRC<sup>®</sup>] and edible oil), solid substrates (*e.g.*, mulch and chitin) and miscellaneous experimental substrates (*e.g.*, hydrogen gas). All of these substrates are biodegraded and ultimately yield (or “release”) hydrogen.

From a practical perspective, the appropriate type of substrate for a given site involves 1) the ability to effectively distribute the substrate throughout the treatment zone, and 2) the ability to sustain the reactive zone with that substrate over the treatment timeframe in a cost-effective manner. In general, the more soluble the substrate the easier it is to mix and distribute throughout the aquifer matrix. But many soluble substrates are readily biodegradable and the need for frequent additions may reduce cost-effectiveness when treatment times transition from a few months to several years.

The longevity of an organic substrate in the subsurface can be manipulated by choosing substrates based upon viscosity, chemical structure, solubility, or physical structure. Various commercial organic substrates like polylactate esters are used, in part, because the high viscosity of the mixture reduces the solubilization of the substrate in the subsurface due to a lesser degree of mixing; less viscous groundwater will flow around the higher viscosity substrate material resulting in a lower rate of dissolution.

Aerobic Conditions

Anaerobic Conditions



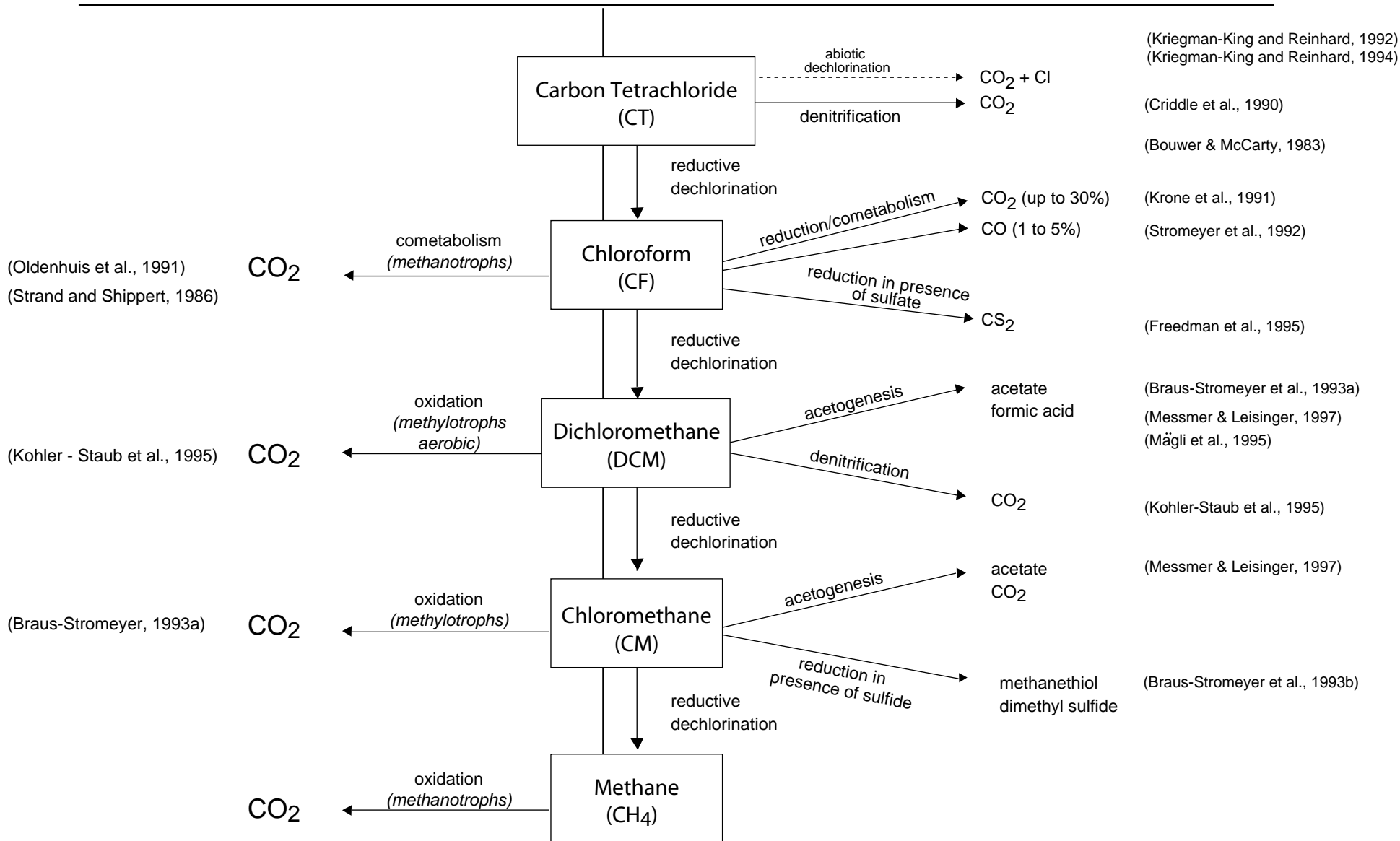
-----> Abiotic Reaction  
-----> Biological Reaction

Figure 1.2: Pathways for the Degradation of Chlorinated Ethenes



Aerobic Conditions

Anaerobic Conditions

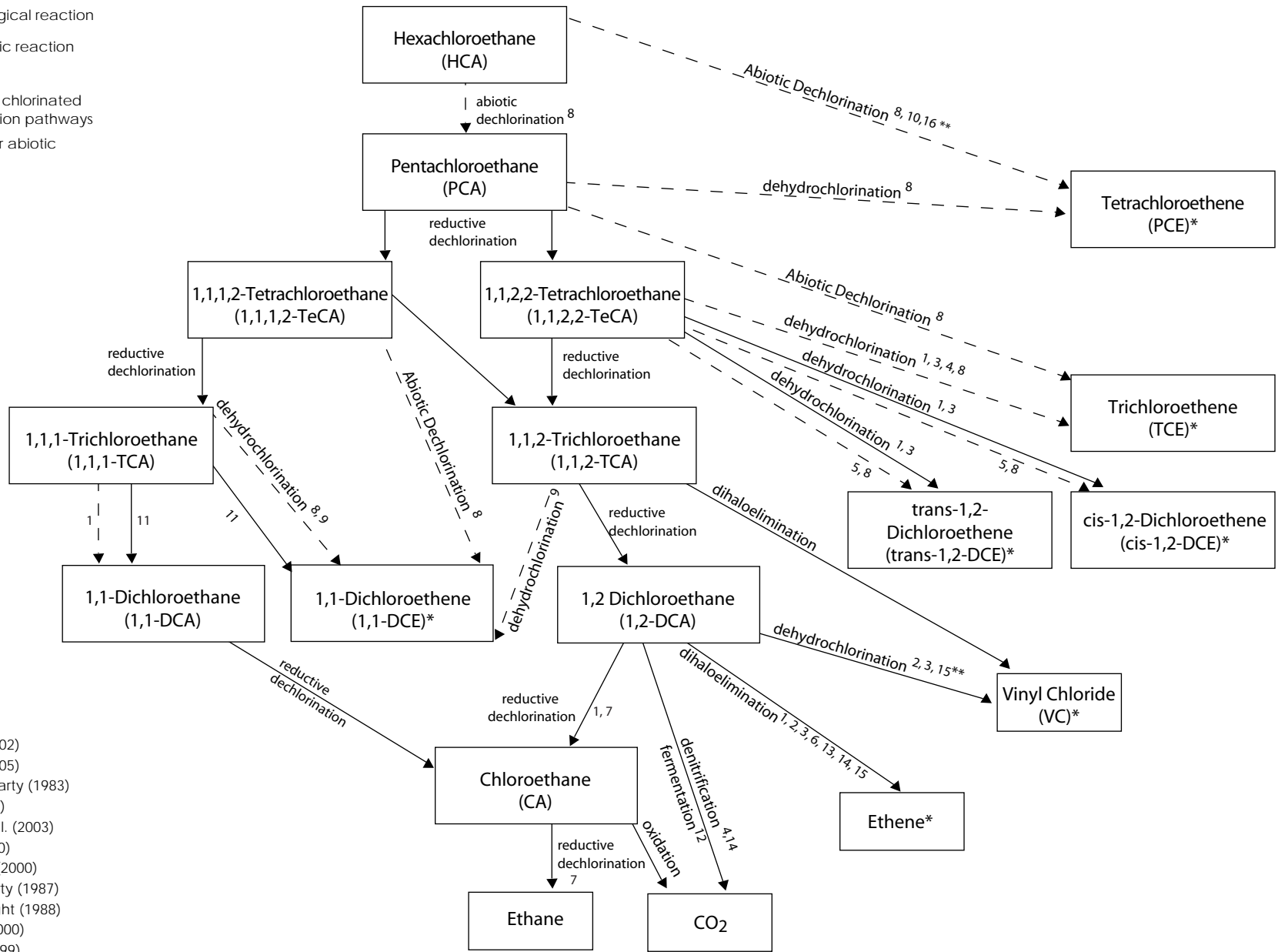


-----> Abiotic Reaction  
 —————> Biological Reaction

Figure 1.3: Pathways for the Degradation of Chlorinated Methanes

—> biological reaction  
 - - -> abiotic reaction

\* See Figure 1.2 for chlorinated ethene degradation pathways  
 \*\* unclear if biotic or abiotic



References

1. Chen et al. (1996)
2. Hunkeler et al. (2002)
3. Hunkeler et al. (2005)
4. Bower and McCarty (1983)
5. Arnold et al. (2002)
6. De Wildeman et al. (2003)
7. Holliger et al. (1990)
8. Butler and Hayes (2000)
9. Vogel and McCarty (1987)
10. Bower and Wright (1988)
11. Gregory et al. (2000)
12. Gerritse et al. (1999)
13. Cox et al. (1998)
14. Cox et al. (2000)
15. Dyer et al. (2000)
16. Butler and Hayes (1998)

Figure 1.4: Pathways for the Anaerobic Degradation of Chlorinated Ethanes

Chemical structure affects longevity in that larger, more complex molecules tend to be less soluble and biodegradable. Solid phase substrates such as bark mulch are used because the physical structure, molecular weight, and complexity of these materials reduces the rate of biodegradation and solubilization of the material, which facilitates substrate longevity. The use of edible oils as an organic substrate provides a straightforward example of the use of a lower solubility material as a means to increase the longevity of this substrate. The use of emulsified vegetable oil is a good example of attempting to lower the viscosity of the substrate to improve the ease and effectiveness of distributing the substrate in the subsurface.

In summary, the first priority is to select a substrate that will support microbial growth and development to create geochemical conditions supportive of complete reductive dechlorination. However, achieving this goal will not be effective unless the distribution and longevity of the substrate are optimized in a site-specific fashion. Thus, the reader is encouraged to always consider the above substrate categories and the final substrate selected in strictly practical terms; namely effective distribution, cost-effectiveness over remediation time frames, and the ability to support substantial reductive dechlorination. A more thorough overview and discussion of the application of all these amendments is provided in the Principles and Practices document. The focus of this protocol is to provide specific guidance on the use and effectiveness of edible oil and edible oil emulsions for this process.

## **1.6 OVERVIEW OF THE EDIBLE OIL PROCESS**

Edible oil has been used in a variety of locations throughout the United States to stimulate anaerobic biodegradation of chlorinated solvents and other contaminants (*e.g.*, perchlorate). Methods used to emplace the oil in the subsurface include injection of pure or neat oil as a separate non-aqueous phase liquid (NAPL) and as an oil-in-water emulsion. Various names have been used in the literature to describe the general edible oil approach including vegetable oil (VegOil), emulsified vegetable oil (EVO), emulsified edible oil (EEO), and emulsified soybean oil (ESO). In this protocol, the term “edible oil process” is used to describe any use of edible fats or oils to stimulate anaerobic biodegradation in the subsurface. The edible oil process is primarily designed to generate anaerobic conditions necessary for microbial reductive dechlorination of chlorinated solvents.

Under certain conditions, hydrophobic (lipophilic) chlorinated solvents will also partition into the edible oil, substantially reducing aqueous phase concentrations and/or contaminant mobility. In this process, known as sequestration, the edible oil can act as a “sponge” to quickly reduce concentrations of chlorinated solvents in groundwater. As chlorinated solvents in the aqueous phase are degraded, additional chlorinated solvent mass will be released from the edible oil due to equilibrium partitioning. Over time, continued degradation of CAHs in the aqueous phase will lower the amount of CAH mass that resides in the oil phase. In addition, the mass of CAHs that is in the oil phase will also be reduced as the mass of oil is degraded. Therefore, sequestration of chlorinated solvents due to partitioning is a ultimately a temporal phenomena if biodegradation of solvents in groundwater can be stimulated and sustained.

Edible oil is by definition a food-grade substrate, with refined soybean oil the most widely used for enhanced *in situ* bioremediation. When properly prepared and injected, edible oil will remain in place due to sorption or entrapment within the aquifer matrix. Due to its low solubility, it is slowly biodegraded in most aquifers. A single, low-cost injection may provide

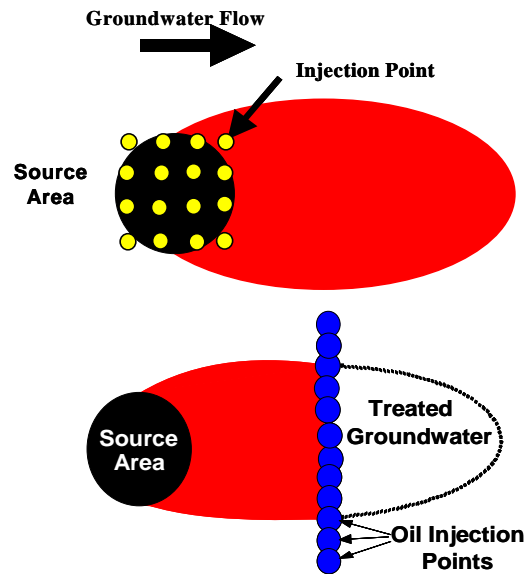
sufficient carbon to drive reductive dechlorination for several years (*e.g.*, see the case study for Cape Canaveral Air Force Station [CCAFS] in [Appendix H](#)). This is expected to significantly lower operations and maintenance (O&M) costs compared to multiple injections of rapidly degraded, soluble carbon substrates (*e.g.*, lactate, ethanol, or sugars). The ability to inject edible oil or emulsified oil allows the placement of a slow-release substrate at locations where placement of solid-phase substrates in a trench or excavation is not feasible (*e.g.*, at depth or in fractured rock). The edible oil process can be applied either in a contaminant source zone or as a biobarrier to migration of a dissolved-phase plume.

Emulsified vegetable oil is the most common form of edible oil applied for enhanced *in situ* bioremediation. Emulsified oil products have been developed using food processing technologies. Surfactants (emulsifiers) are added to the oil and the oil is mixed with water by a high energy shearing process (most commonly homogenization) to create a stable oil-in-water emulsion. “Microemulsions” are herein defined as emulsions having a mean droplet size less than the mean pore throat size of the formation to which it will be applied. The benefit of an oil-in-water emulsion is the ability to readily inject the product throughout the intended treatment zone.

To date, the edible oil process has been implemented by the AFCEE Technology Transfer Outreach Office and the Naval Facilities Engineering Command (NAVFAC) at multiple DoD facilities. Many of the DoD the sites where the edible oil process has been used are identified in [Appendix B](#).

### 1.6.1 Treatment System Configurations

Treatment configurations for contaminated aquifers using edible oil include source area treatment and biobarriers along the axis of the contaminant plume ([Figure 1.5](#)). In choosing a treatment approach for a given site, it is important to understand the overall objectives of the project. The objectives may be to reduce contaminant concentrations to below MCLs, to reduce mass discharge as part of an overall risk reduction approach, or to limit plume migration.



**Figure 1.5** Example System Configurations for Using Edible Oil to Treat Contaminated Groundwater in: (a) Source Areas and (b) Biobarriers

### 1.6.1.1 Source Areas

Source areas provide several challenges when being considered for treatment. Source areas typically include chlorinated solvents in the dissolved, sorbed, and DNAPL phases. Addition of edible oil can rapidly reduce contaminant concentrations in the aqueous phase by partitioning of a portion of the solvent mass into the edible oil (*i.e.*, sequestration). Biodegradation of the oil will then stimulate anaerobic conditions and rapid biodegradation of solvents in the aqueous phase. As contaminants are slowly released by desorption from the aquifer matrix or by dissolution from residual DNAPL, edible oil will still be present to sustain anaerobic biodegradation processes.

Source areas can be treated using pure edible oil or an edible oil emulsion. The residual saturations for pure oil are generally much higher than for emulsions. Consequently, pure edible oil is most useful when the objective is to sequester chlorinated solvents in the oil phase and to block the aquifer pore spaces, reducing groundwater flow in the treatment zone and mass discharge from the source area.

Edible oil emulsions are generally applied at lower residual saturations, typically at 1.0 to 10 percent of the aquifer pore volume. Consequently, emulsions will be less effective for sequestering chlorinated solvents and reducing groundwater flow than pure oil. However, if the objective is to primarily stimulate biodegradation for mass removal in the source area, emulsions are beneficial because they are easier to distribute over a greater volume of the aquifer and with a more uniform distribution than pure oil. Source areas may take long periods of time to remediate and additional injections may be required if the lesser amounts of substrate used in an emulsion are depleted prior to obtaining remedial objectives.

### 1.6.1.2 Permeable Biobarriers

In many cases, the source of a contaminant plume is poorly defined or a plume is a result of multiple dispersed sources where source containment/reduction is not feasible. In other cases, it may be desirable to intercept a contaminant plume upgradient of a property boundary or a potential receptor. Under these conditions, edible oil can be injected in a permeable biobarrier configuration for plume treatment or plume containment. As with any permeable barrier configuration, the reaction zone must be uniformly distributed and an effort made to maintain the permeability of the reaction zone.

Biobarriers are typically installed across the plume, perpendicular to groundwater flow ([Figure 1.5](#)). The barrier width should be wider than the width of the contaminant plume that requires remediation to allow for uncertainties in the actual plume dimensions, variations in groundwater flow direction, and to allow for some permeability loss. Residence time within the barrier reaction zone will be controlled by the groundwater flow velocity and barrier thickness along the direction of groundwater flow.

## 1.6.2 Edible Oil

A number of edible oils and fats are used in the food and animal feed industries. Based on commodity pricing and ease of handling, refined soybean oil has been used for most edible oil applications and is the base product for commercially available oil-in-water microemulsions. The properties and behavior of edible oil and edible oil microemulsions are described in detail in [Appendix D](#). The low solubility of edible oil provides for a long-lasting carbon source due

to a slow rate of chemical dissolution into groundwater. Edible oil is also readily biodegraded in the subsurface (Parsons, 2004a). Therefore, the longevity of the substrate is also a function of the rate at which it is biodegraded, versus the rate of chemical dissolution alone.

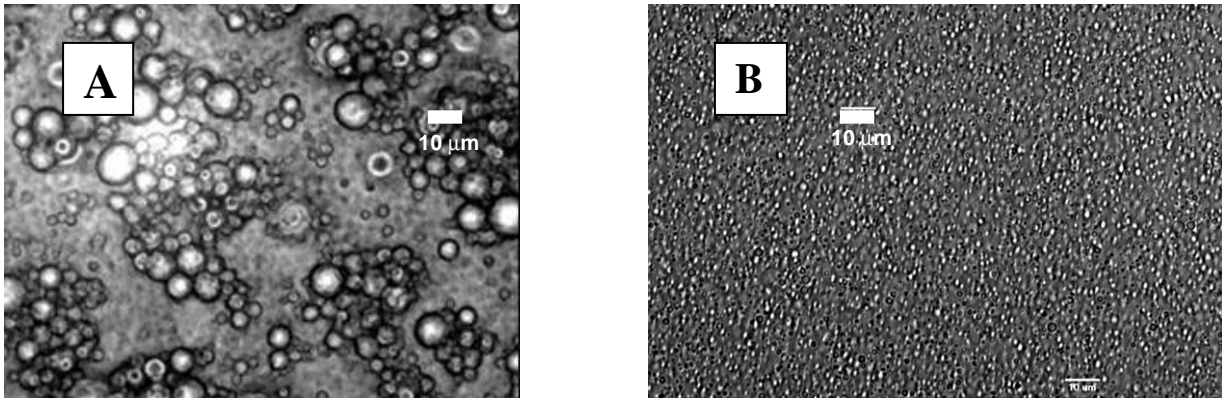
**Pure Edible Oil** may be used in some source area applications or may be purchased for emulsification in the field. In addition, pure edible oil is often used as a supplemental organic substrate by coating mulch mixtures installed in permeable mulch biowalls (*e.g.*, Cowan *et al.*, 2000). Refined soybean oil can be purchased in bulk from a number of wholesale distributors at costs of \$0.40 to \$0.50 per pound (excluding delivery). A description of the properties of soybean and other common vegetable oils can be found in [Appendix D](#).

**Edible Oil Emulsions** are more commonly applied than pure oil due to ease of injection and distribution. Sedimentary deposits have a broad range of pore throat sizes, over several orders of magnitude from less than 1.0 micron to over 100 microns. For practical consideration, microemulsions should have a mean droplet size of less than 1.0 to 2.0 microns for applications in sediments containing very fine sand or silt. Applications in carbonate or fractured rock require additional consideration of secondary porosity and fracture size.

Commercial emulsion products are proprietary formulations, but typically contain 45 to 60 percent soybean oil by weight, and from 5 to 10 percent emulsifiers by weight. They are sold as concentrates that are miscible in water and readily diluted for field application, typically to concentrations of 1 to 10 percent oil by volume. Microemulsion products may be modified by the manufacturer to include additional nutrients and amendments (*e.g.*, yeast extract, vitamin B12 and up to 5 percent by weight sodium lactate). Surfactants (emulsifiers) used may be ionic (*e.g.*, lecithin) or non-ionic (*e.g.*, polysorbate), the appropriate use of which should depend upon the properties of the aquifer matrix. Costs for microemulsion products typically range from \$1.25 to \$2.00 per pound of bulk product (excluding delivery). The percent of active ingredient and inclusion of nutrient amendments should be taken into account when comparing unit rates between various products.

Oil-in-water emulsions may be mixed in the field. The Solae Company (a subsidiary of the Bunge Corporation) manufactures a soybean oil product (Textrol BR) mixed with an appropriate concentration of lecithin and other proprietary emulsifiers for this purpose. Preparing a suitable emulsion in the field is related to the degree of mixing necessary to create a uniform emulsion of small droplet size. It may not always be practical to prepare field emulsions of suitable droplet size for many fine-grained sediments that contain silt and clay. In-line mixers and small shear mixers may create emulsions with droplet sizes ranging from 5 to 20 microns in diameter, compared to commercial emulsions with droplets of 1 to 2 microns in diameter. The use of a commercial homogenizer may be used in the field to achieve such small droplet sizes, but this type of equipment may not be practical or cost effective to mobilize to a field location for applications of less than several thousands of gallons of emulsion.

A comparison of droplet size for a field mixed emulsion and a commercial microemulsion is shown on [Figure 1.6](#). The relative cost of a pre-emulsified commercial product versus materials, equipment and labor required for field emulsification makes use of a commercial product favorable for many applications.



**Figure 1.6 Photomicrographs of Oil-in-Water Emulsions: (a) produced in the field with a high shear mixer and (b) a pre-mixed emulsion (white scale bar is 10 microns)**

**Related Edible Oil Products.** In addition to pure edible oil and emulsified oil, there are an increasing number of commercial bioremediation products that contain edible oil components, long chain fatty acids (*e.g.*, ethyl lactate), or biodegradable polymers which are applied in a similar manner to emulsified oil. Emulsified zero valent iron is also being developed for *in situ* remediation of chlorinated solvents. A non-exhaustive listing of vendors offering edible oil or very similar bioremediation products are listed in [Appendix C](#).

### 1.6.3 Application Methods

Two general approaches have been used to distribute edible oil in the subsurface: 1) injection of pure edible oil, and 2) injection of an oil-in-water emulsion. The use of pure-phase edible oil has been primarily direct injection into source areas. Pure edible oil may also be used to coat mulch or sand placed in biowall trenches (*e.g.*, Cowan *et al.*, 2000) or bioreactor excavations, or used to coat the bottom of source area excavations prior to backfilling. A more common approach is the injection of dilute oil-in-water emulsions. Edible oil may pose a risk to the environment if allowed to migrate into surface waters, and injection designs should include pre-cautions to prevent surface discharge.

#### 1.6.3.1 Pure Edible Oil

Pure or neat edible oil can be injected directly into an aquifer using conventional wells or using temporary direct push points ([Figure 1.7](#)). Injection pure oil results in high oil saturations and large reductions in the permeability of the formation to water. Typically, injection of pure oil will occupy greater than 30 percent of the aquifer pore space immediately adjoining the injection point. The use of pure edible oil in this manner may require injection of large volumes of oil if uniform distribution of the oil is desired. However, these high oil saturations will also partition a greater mass of chlorinated solvents present in the aquifer at or near the injection point, resulting in an initial larger decrease in CAH concentrations.

To push the oil farther out away from the injection point, additional oil or a water “chase” must be injected. A water “chase” has a limited ability to distribute the oil into the formation as the water will follow the path of least resistance and tend to bypass the oil.



**Figure 1.7 Direct Injection of Pure Edible Oil through Geoprobe® Rods Using a Grout Pump**

As mentioned above, injection of pure edible oil dramatically reduces the permeability of the treated zone to water. A loss in permeability presents a challenge for a permeable barrier system since contaminated groundwater would tend to flow around the barrier, not through it. However, a reduction in permeability in a source area may be an advantage since this will reduce groundwater flow through the injection area/contaminated zone, reducing the mass discharge of contaminant to the downgradient aquifer. Therefore, the direct injection of pure edible oil is only considered appropriate for source area applications in this protocol.

### **1.6.3.2 Oil-in-Water Emulsions**

Edible oil can be distributed in aquifers as oil-in-water emulsions. Ideally, the emulsion should be stable (*e.g.*, non-coalescing); have small, uniform droplets to allow transport in the aquifer; and have a negative surface charge to reduce droplet capture by the solid surfaces. The emulsion is injected into the subsurface at a desired oil saturation (*i.e.*, dilution), and may be followed by a water chase to further distribute the oil droplets.

As oil droplets migrate through an aquifer, they collide with sediment surfaces and become lodged within the aquifer matrix pore space. Aquifer matrices are water wet, so the oil will not displace the water at the matrix surface. Rather, the oil droplets will sorb to the solid matrix based on the ionic charge between the matrix and the emulsifier(s) used to create the oil droplets. Larger droplets may also be entrapped where the droplet size is greater than the pore throat and the entry pressure is not sufficient to force the oil through the pore throat. Many droplets will accumulate within the aquifer pore space in this way, and provide a carbon source for long-term reductive dechlorination.



These processes also act to limit the mobility of the oil droplets once the emulsion is injected throughout the treatment zone. Field and laboratory studies (Borden *et al.*, 2004; Coulibaly and Borden, 2004; Solutions IES, 2006) have shown that emulsified oil can be injected in many common aquifer materials with low to moderate oil retention, and with permeability loss less than an order of magnitude. As a consequence, emulsified edible oil is more appropriate than pure oil for use in biobarrier configurations where minimizing permeability loss is important.

The equipment required to inject water-in-oil emulsions is relatively simple. Typically, native groundwater is extracted and collected in a holding tank. The product is provided in drums or totes, and the product and make-up water are mixed in a batch tank at appropriate volumes. The emulsion mixture is injected into injection wells or direct-push points using a system of pumps, flow meters, control valves, and pressure gauges. Injection into multiple wells may be accomplished using an injection manifold to expedite the injection process. Injection wells, feed lines with flow meters and control valves, an injection pump, emulsion mixing tank, and make-up water tank are shown in **Figure 1.8**. At sites with adequate permeability, native groundwater may be extracted and amended “in-line” without the need for large holding tanks. More detail on injection methods is provided in **Section 5**.

A permeable biobarrier may be configured by injecting an edible oil emulsion through a series of temporary or permanent wells installed perpendicular to groundwater flow (**Figure 1.5** and **Figure 1.8**). As groundwater moves through the treated zone under a natural hydraulic gradient, a portion of the oil dissolves or degrades providing a carbon and energy source to accelerate anaerobic biodegradation processes. Edible oil emulsions are suitable for biobarriers because the loss in permeability by entrapped or sorbed oil is minimized. If permeability loss were excessive, contaminated groundwater could flow around the barrier and not be treated.



**Figure 1.8** Typical Oil Emulsion Injection System Layout

### 1.6.4 Design and Implementation of Edible Oil Applications

Depending on the project remedial objectives, the practitioner must decide which type of edible oil application provides the best opportunity to meet the project goals. Some of the relative advantages and disadvantages of source area and biobarrier approaches are summarized in **Table 1.2**. Some of the major strengths and limitations of using pure edible oil versus edible oil emulsions are summarized in **Table 1.3**. These are considerations taken into account when designing an appropriate edible oil application.

The design of an edible oil applications involves many factors regarding remedial objectives and site-specific contaminant distribution, hydrogeology, and geochemistry. In many cases, pilot testing is beneficial to determine the optimum approach for full-scale applications (**Section 3**). **Section 4** describes the design of full-scale edible oil applications for source areas and biobarriers. Edible oil and edible oil emulsions require special equipment and procedures for handling and injection. **Section 5** describes the distribution of edible oil and edible oil emulsions in the subsurface and the methods and equipment used to mix and inject edible oil.

**Table 1.2**  
**Source Area Treatment Versus Permeable Biobarrier Designs**

<b>Source Area Treatment</b>	<b>Permeable Reactive Barrier</b>
<p><b>POTENTIAL BENEFITS</b></p> <ul style="list-style-type: none"> <li>➤ Sequesters and remediates source</li> <li>➤ Reduces mass flux of dissolved contaminants</li> <li>➤ Compatible with natural attenuation</li> <li>➤ Provide post-treatment to other source area treatments (<i>e.g.</i>, surfactant flush or resistive heating)</li> <li>➤ Potentially more cost-effective than alternative remedial technologies</li> </ul>	<p><b>POTENTIAL BENEFITS</b></p> <ul style="list-style-type: none"> <li>➤ Controls plume migration</li> <li>➤ Less precise delineation of source area is required</li> <li>➤ Can be use to remediate extensive dissolved phase plumes (series of barriers)</li> <li>➤ Compatible with natural attenuation</li> <li>➤ Helps protect downgradient receptors</li> <li>➤ Potentially lower cost than other barrier technologies, especially at deeper sites</li> </ul>
<p><b>POTENTIAL LIMITATIONS</b></p> <ul style="list-style-type: none"> <li>➤ Requires more precise delineation of source area</li> <li>➤ Probably not effective for large volumes of DNAPL</li> <li>➤ May require decades to fully remediate source area</li> </ul>	<p><b>POTENTIAL LIMITATIONS</b></p> <ul style="list-style-type: none"> <li>➤ Does not eliminate source</li> <li>➤ If plume source is not controlled, additional oil injections will be required to maintain performance</li> <li>➤ If permeability loss is excessive, plume could flow around barrier</li> </ul>
<p><b>TYPICAL DESIGNS</b></p> <ul style="list-style-type: none"> <li>➤ Injection points distributed throughout source</li> <li>➤ Temporary recirculation systems to smear oil thorough out source</li> <li>➤ Rows of barriers spaced at intervals based on time to achieve remedial objectives and economics of injection</li> </ul>	<p><b>TYPICAL DESIGNS</b></p> <ul style="list-style-type: none"> <li>➤ Row of injection points perpendicular to groundwater flow direction</li> <li>➤ Multiple barriers can be used to achieve higher removal efficiencies or reduce cleanup time for long plumes</li> </ul>

**Table 1.3**  
**Comparison of Injection of Pure Edible Oil Versus an Oil-In-Water Emulsion**

<b>Pure Edible Oil</b>	<b>Oil-in-Water Emulsion</b>
<p><b>Characteristics</b></p> <ul style="list-style-type: none"> <li>➤ High residual saturation</li> <li>➤ Large permeability loss</li> <li>➤ Can sequester chlorinated solvents</li> </ul>	<p><b>Characteristics</b></p> <ul style="list-style-type: none"> <li>➤ Low residual saturation</li> <li>➤ Low permeability loss</li> <li>➤ Limited chlorinated solvent sequestration</li> </ul>
<p><b>Strengths</b></p> <ul style="list-style-type: none"> <li>➤ Easy to implement</li> <li>➤ Relatively low cost</li> <li>➤ Can inject with temporary or direct push points</li> </ul>	<p><b>Strengths</b></p> <ul style="list-style-type: none"> <li>➤ Easy to implement</li> <li>➤ Relatively low cost</li> <li>➤ Can distribute emulsion greater distances from injection point</li> <li>➤ More uniform distribution of oil</li> <li>➤ Potential to add other co-substrates (<i>e.g.</i>, lactate, yeast extract, vitamins)</li> </ul>
<p><b>Limitations</b></p> <ul style="list-style-type: none"> <li>➤ Limited spread of oil</li> <li>➤ Requires relatively larger amounts of oil</li> <li>➤ Possibility that oil will float</li> <li>➤ High oil concentrations may lead to excessive fatty acid production, leading to depression of pH and stalling bioactivity</li> </ul>	<p><b>Limitations</b></p> <ul style="list-style-type: none"> <li>➤ Can require a large amount of chase water to distribute/immobilize oil</li> <li>➤ Emulsion preparation is more complicated</li> <li>➤ May require additional injections to sustain reactive zone over periods of years</li> </ul>

## SECTION 2

### PRELIMINARY SCREENING

#### 2.1 ROAD MAP FOR PRELIMINARY SCREENING

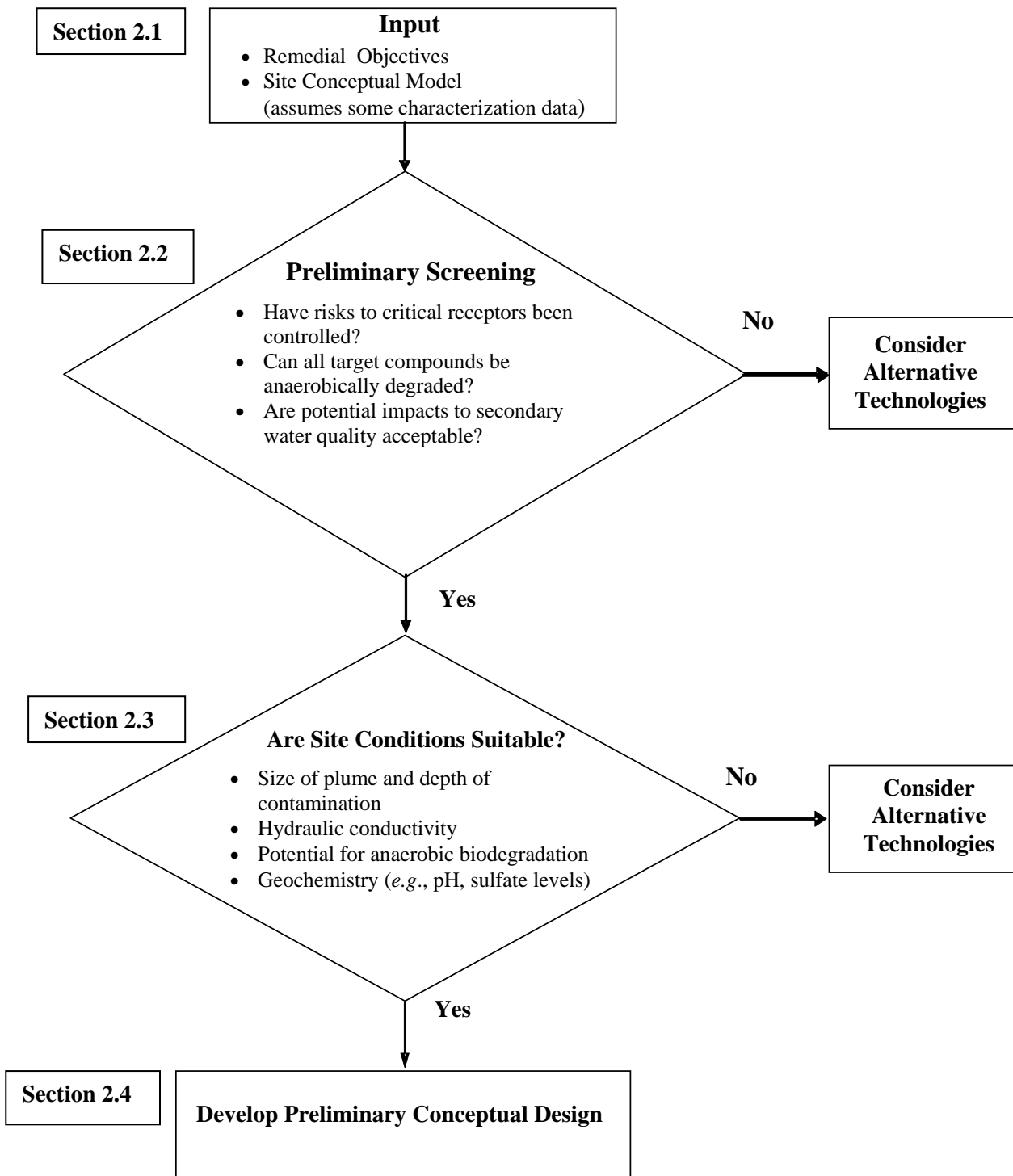
Many *in situ* remedies fail to meet performance objectives due to inadequate site characterization or due to lack of screening for site-specific limitations. **Figure 2.1** shows a road map that site managers can follow to perform a preliminary screening of whether the edible oil process is appropriate for use at their site. The intent of this road map is to aid in quickly identifying “road blocks” that may slow implementation, increase costs or lead to failure of this process.

*Many in situ remedies fail to meet performance objectives due to inadequate site characterization or screening for site-specific limitations. Preliminary screening is a first, critical step to successful implementation of the edible oil process.*

The first steps are to develop and refine a site-specific contaminant and hydrogeologic conceptual site model (CSM) and to develop remedial objectives. A CSM summarizes the fate and transport of contaminants, migration pathways, exposure mechanisms, and potential receptors. Remedial objectives reflect the need to reduce the risk of exposure to protect human health and the environment.

The CSM should be used to evaluate the potential for preferential flows paths and/or low permeability materials that would complicate effective substrate distribution. An assessment of the potential to stimulate anaerobic reductive dechlorination or other anaerobic degradation processes is based upon a review of site-specific data including contaminant distribution and trends, and biogeochemical conditions (electron donors, electron acceptors, metabolic byproducts, and general geochemical indicators). The CSM should also provide information regarding the compatibility of existing geochemical conditions with enhanced anaerobic biodegradation.

Site screening considerations and site characterization considerations for selection, development, and evaluation of an edible oil application are described in the following sections. Most sites being evaluated for enhanced *in situ* anaerobic bioremediation generally have been investigated and characterized to some extent, and a limited assessment of remedial alternatives has been conducted. Where sufficient data has not been collected, additional site characterization is advised.



**Figure 2.1 Road Map for Preliminary Screening of the Edible Oil Process**

## 2.2 SITE SCREENING CONSIDERATIONS

When anaerobic bioremediation using edible oil is first considered for a site, four critical questions should be answered.

- Have risks to critical receptors already been controlled?
- Can all target contaminants be anaerobically degraded by biotic or abiotic processes?
- Are potential secondary water quality impacts acceptable?
- Are site conditions suitable for implementing the edible oil process?

The first three questions are discussed in the following paragraphs. Site conditions suitable for applying the edible oil process are described in detail in [Section 2.3](#).

**Risks to Critical Receptors.** The first priority in environmental remediation is to prevent exposure to the contaminants of concern. In addition, enhanced *in situ* anaerobic bioremediation of chlorinated solvents may generate toxic intermediate degradation products. Therefore, if a critical receptor such as a water supply well is located a short distance downgradient of the impacted zone, then potential risks need to be controlled before implementation of the edible oil process. Potential alternatives include relocation of the water supply well or providing an alternative water source. Once these risks are controlled, the use of edible oil can be reconsidered.

**Anaerobic Biodegradability.** There are a wide variety of compounds that can be anaerobically biodegraded including chlorinated ethenes, chlorinated ethanes, chlorinated methanes, perchlorate, nitrate, and explosives (*e.g.*, RDX, TNT). Site managers considering use of the edible oil process should carefully review the information provided in the Principles and Practices document to determine if all of the target contaminants at their site are anaerobically biodegradable and the level of experience in treating these contaminants.

For a few of these compounds (*e.g.*, PCE, TCE, perchlorate, and nitrate), the biodegradation pathways and microorganisms that carry out this process are relatively well understood and enhanced anaerobic biodegradation has been demonstrated in the field at multiple sites. For example, the microbiology of PCE and TCE biodegradation is relatively well understood and there is considerable practical experience with anaerobic biodegradation of PCE and TCE. In contrast, field experience with *in situ* anaerobic biodegradation of 1,1,1-TCA or CT is more limited and the environmental conditions and microorganisms that are required for the complete biodegradation of these compounds are less well understood.

Site managers should review available cases studies in the literature for the chlorinated solvents present, and use caution when extrapolating results from laboratory studies to the field. Microcosms may be considered when the potential for complete biodegradation at a site is in question. Further discussion of microcosm studies can be found in Section 4.3 of the Principles and Practices document. The science of anaerobic degradation of other chlorinated compounds in addition to PCE and TCE is advancing rapidly. Demonstrations at the field scale may reveal practices that can optimize enhanced bioremediation of these compounds.

Bioaugmentation is an option when the potential for complete degradation of chlorinated solvents is in question (ESTCP, 2005). Bioaugmentation should be considered when native dechlorinating species capable of complete dechlorination of CAHs are not present, are poorly distributed, or are present at low population densities. Bioaugmentation may be implemented either from inception or as a contingency measure should degradation stall at intermediate dechlorination products or fail to produce significant biodegradation. However, bioaugmentation may not be suitable for many sites, and bioaugmentation cultures are not readily available for all classes of chlorinated compounds. A pragmatic approach is to conduct a cost/benefit analysis considering the cost of bioaugmentation, its potential benefits, and the risk of not using bioaugmentation. Further discussion of bioaugmentation can be found in Section 4.6 of the Principles and Practices document.

***Secondary Water Quality and Generation of Noxious Gases.*** The term “secondary water quality” is used in this document to refer to water quality issues or concerns that result from substrate addition and are apart from the primary contaminants being treated. Degradation of secondary water quality can occur as a result of a reduced groundwater environment that may increase the mobility of some naturally occurring, but regulated metals in the aquifer matrix (*e.g.*, iron, manganese, and arsenic). While these metals are more soluble under reducing conditions, migration of metals out of the reactive zone is often substantially retarded by adsorption to the aquifer matrix and/or precipitation as insoluble metal sulfides (*e.g.*, Butler and Hayes, 1999).

Other secondary water quality parameters that may be degraded upon substrate addition include chemical oxygen demand (COD), biochemical oxygen demand (BOD), total dissolved solids (TDS), fatty acids, sulfides, and metals that affect taste and odor. Fermentation effects also may create conditions conducive to formation of aldehydes, ketones and mercaptans that have taste and odor impacts. These parameters should be monitored if regulated at the site.

In naturally aerobic aquifers where *in situ* anaerobic bioremediation has been applied, groundwater typically returns to near background conditions within a relatively short distance downgradient of the reactive zone. As groundwater migrates downgradient, the excess substrate will be consumed by biological processes, and the anaerobic groundwater will mix with background aerobic groundwater resulting in precipitation / immobilization of dissolved metals. In naturally anaerobic aquifers, secondary water quality impacts may extend farther downgradient. However, the groundwater quality in naturally anaerobic aquifers is generally not of drinking water quality or beneficial use.

Stimulating biodegradation also may enhance generation of gaseous byproducts (*e.g.*, methane and hydrogen sulfide) that may degrade groundwater quality or accumulate in the vadose zone. In particular, caution must be exercised when operating near structures where these gases could accumulate. Passive diffusion of these gases to the atmosphere is often sufficient to mitigate any safety concerns. Monitoring of potentially explosive methane gas should be considered for public safety as well as the safety of the field staff. If necessary, subsurface gases can be vented to the atmosphere to protect against exposure or accumulation.

The potential for degradation of secondary water quality should be considered when working in close proximity to drinking water supplies. It also should be noted that these changes in water quality, and those discussed under generation of gaseous byproducts, are not easily reversed, and in the case of a slow release carbon source may take many years for the effects of the substrate addition to diminish. These secondary water quality issues should be

carefully considered before proceeding with an enhanced anaerobic bioremediation project. Specific groundwater quality goals should be established for wells upgradient of sensitive areas, but allow for temporal increases in breakdown or byproducts within the reactive zone.

### 2.3 SITE CONDITIONS SUITABLE FOR EDIBLE OIL APPLICATIONS

Enhanced anaerobic bioremediation using edible oil is a flexible technology that can be implemented in a variety of different environments including homogenous sands, fractured clay or limestone, or weathered bedrock. However, to be effective, the oil must be brought into close contact with the contaminant under conditions suitable for microbial growth. Site conditions that make this more difficult will increase the cost of implementation and risk of failure.

Site conditions that may increase costs or reduce the likelihood of success are summarized in **Table 2.1** and discussed in more detail in subsections following the table. In some cases, even though the cost may be higher, the edible oil system design may be modified to account for challenging site characteristics to provide an effective remedy (*e.g.*, pH amendments or amendments to stimulate biogeochemical reduction).

**Table 2.1**  
**Site Characteristics Suitable for the Edible Oil Process**

Site Characteristic	Simple to Implement – Lower Costs	Intermediate Costs	More Difficult to Implement – Higher Costs
Biodegradation Potential	Environments where reductive dechlorination is apparent but limited due to a lack of organic substrate	Environments where dechlorination is stalled and dechlorinating bacteria may not be present	Environments where no biodegradation is apparent and appropriate dechlorinating bacteria are not present
Source Area Size	< 1 acre	1 to 4 acres	> 4 acres
Plume Size	< 5 acres	5 to 20 acres	>20 acres (Consider biobarriers to control plume migration)
Depth of Contamination	< 50 feet	50 – 100 feet	> 100 feet
Hydraulic Conductivity	> 10 ft/day	1 to 10 ft/day	< 1 ft/day
Groundwater Velocity	20 ft/yr to 2 ft/day	1 ft/yr to 20 ft/yr; 2 ft/day to 5 ft/day	< 1 ft/yr or > 5 ft/day
Degree of Aquifer Heterogeneity	Homogeneous Aquifers	Moderate Heterogeneity	Highly heterogeneous aquifers where contaminant flow paths are difficult to characterize
Sulfate Concentration	< 500 mg/L	500 to 5000 mg/L *	> 5,000 mg/L *
pH	6.5 to 8.5	5.5 to 6.5	< 5.5 or > 8.5

Note: ft/day = feet per day, ft/yr = feet per year, mg/L = milligrams per liter.

\* The presence of elevated concentrations of sulfate can decrease the utilization of substrate for biotic dechlorination of chlorinated solvents with an increase in substrate costs. However, the formation of reactive iron sulfides may facilitate treatment of chlorinated solvents via biogeochemical reduction.



### 2.3.1 Potential for Reductive Dechlorination

#### 2.3.1.1 Types of Groundwater Environments

USEPA (1998) describes three types of environments and their potential for natural biodegradation of chlorinated solvents. The Principles and Practices document also describes the impact of these environments during application of enhanced anaerobic bioremediation. These environments are reviewed briefly below:

Type 1 Environment. The Type 1 environment is typified by pre-existing strongly reducing conditions. The driving force may be naturally-occurring organic matter or anthropogenic carbon such as petroleum hydrocarbons from an unrelated release. The environment is characterized by very low concentrations of dissolved oxygen (DO), nitrate, and sulfate; and elevated concentrations of ferrous iron [Fe(II)] and methane. The presence of methane confirms that fermentation is occurring at the site. As discussed in the Principles and Practices document, the Type 1 environment typically results in rapid and extensive dechlorination of the more highly chlorinated solvents such as PCE, TCE, CT, and 1,1,1-TCA. For this reason, it may be likely that natural attenuation can continue unabated, and addition of edible oil is not required to stimulate contaminant biodegradation.

Type 2 Environment: Type 2 environments occur in hydrogeologic settings that have relatively moderate organic carbon concentrations. Prevailing oxidation-reduction (redox) conditions in a Type 2 environment are mildly anaerobic, with the primary redox reactions being nitrate-, manganese-, and iron-reduction. Type 2 environments are differentiated from Type 1 environments in that the levels of organic carbon are not sufficient to induce widespread sulfate reduction and methanogenesis. Some Type 1 environments may become Type 2 environments if the amount of bioavailable organic carbon is depleted. The Type 2 environment generally results in slower dechlorination of the highly-chlorinated CAHs and incomplete dechlorination of lesser-chlorinated CAHs (*e.g.*, *cis*-1,2-DCE) compared to a Type 1 environment. Despite the initial limitations, the Type 2 environment is well suited for enhancement by addition of edible oil. Given sufficient substrate, this environment may be modified to a Type 1 environment resulting in rapid and complete degradation of CAHs.

Type 3 Environment: A Type 3 environment is characterized by a well-oxygenated groundwater system with little or no organic matter. In such an environment, anaerobic dechlorination will not naturally occur and highly-chlorinated CAHs such as PCE, TCE, TCA, and CT will not degrade by biological processes. In this environment, very long dissolved-phase plumes are more likely to form. However, less-chlorinated CAHs such as VC (and possibly DCE) can be rapidly oxidized under these conditions. Addition of an organic substrate may readily induce anaerobic conditions, but an acclimation period of several months to perhaps a few years may be required for anaerobic microorganisms capable of degrading the CAHs present to adapt and grow to a population sufficient to effectively remediate the site.

#### 2.3.1.2 Assessing the Potential for Reductive Dechlorination

Interpretation of contaminant and geochemical data as it applies to *in situ* bioremediation of chlorinated solvents is described in USEPA (1998), Wiedemeier *et al.* (1999), and AFCEE *et al.* (2004). Reductions in contaminant concentrations and the presence of dechlorination products are used to determine if anaerobic reductive dechlorination is occurring. Evidence

that anaerobic reductive dechlorination is occurring naturally is a favorable indicator for stimulating the process by addition of edible oil. Lack of evidence of natural anaerobic reductive dechlorination does not exclude the use of enhanced anaerobic bioremediation, but may result in an extended lag phase for acclimation and growth of anaerobic microorganisms capable of reductive dechlorination of CAHs.

Screening for appropriate dechlorinating microorganisms is another tool for determining the potential for reductive dechlorination ([Section 3.6.4](#)). For example, quantitative screening for *Dehalococcoides* species is useful to determine the potential for complete dechlorination of chlorinated ethenes (for a review of molecular biological tools see Strategic Environmental Research and Development program [SERDP] and ESTCP, 2005). Detection limits for quantitative polymerase chain reaction (PCR) methods are now capable of detecting low concentrations of *Dehalococcoides* species.

Assessing biological activity in the subsurface based on groundwater monitoring data alone can be difficult. However, there are a number of monitoring parameters that are indicative of anaerobic reductive dechlorination or of conditions optimal for the process to occur. These indications include the following:

- The transformation of PCE and TCE to isomers of DCE, VC, and ethene (or similar sequential dechlorination of chloroethanes and chloromethanes).
- Some researchers report that, of the three possible DCE isomers, 1,1-DCE is the least common intermediate of the dechlorination of TCE, and that *cis*-1,2-DCE often predominates over *trans*-1,2-DCE (Barrio-Lage *et al.*, 1987; Parsons *et al.*, 1985). If *cis*-1,2-DCE comprises more than 80 percent of the total mass of the DCE isomers, then this suggests that DCE is being produced as a result of dechlorination of TCE. At sites where 1,1,1-TCA is present, 1,1-DCE may be a significant intermediate due to dehydrochlorination (*e.g.*, Vogel and McCarty, 1987).
- Ethene and/or ethane are being produced (even low concentrations are indicative of biodegradation).
- Because chlorinated ethenes are 55 to 85 percent chlorine by mass, the degradation of these compounds releases a large mass of chloride. Therefore, elevated chloride concentrations may indicate reductive dechlorination of chlorinated ethenes or other CAHs. Note that many groundwater systems are naturally high in chloride (*e.g.*, brackish water in coastal environments), and the production of chloride may be masked by natural concentrations.
- DO concentrations are low (less than 0.5 milligrams per liter [mg/L]), and redox values are low (less than 0.0 millivolts [mV]).
- Fe(II) is being produced, and nitrate and sulfate are low or depleted.
- The production of methane indicates that fermentation is occurring and that the potential for anaerobic reductive dechlorination exists.

- Hydrogen concentrations are greater than 1 nanomole per liter (nmol/L). Specialized sample procedures are required for dissolved hydrogen (Chappelle, *et al.*, 1997) and care should be taken in collecting and evaluating these data.

Evidence that any of these factors occurs naturally is highly favorable for implementing enhanced anaerobic bioremediation. However, the absence of these conditions does not preclude the use of enhanced bioremediation, as addition of edible oil is intended to induce the appropriate conditions. Baseline characterization is required in order to determine if substrate addition induces the desired changes in redox conditions, and an evaluation of the effectiveness of enhanced bioremediation requires the rates of natural biodegradation to be known for comparison purposes.

Despite the potential for being able to create the appropriate reducing environment *in situ*, the Type 3 environment may be a challenge for enhanced anaerobic bioremediation primarily due to a lack of an adapted anaerobic microbial population. DO concentrations greater than 1.0 mg/L are generally toxic to anaerobic dechlorinating species, and it is logical to assume that these bacteria may only be present in small quantities in a dormant state. However, given the degree of microbial heterogeneity and presence of anaerobic “micro-environments” observed at many sites, there is a strong possibility that anaerobic conditions can be induced at Type 3 sites. Thus, although Type 3 environments may not be suitable for natural attenuation, these sites may still be treated to enhance reductive dechlorination.

Prior to implementing the technology at Type 3 sites, laboratory or field pilot testing may be useful to measure the potential for the amendment to stimulate biodegradation in site-specific matrices. Microcosm studies may be useful to determine the potential to stimulate anaerobic reductive dechlorination (see Section 4.3 of the Principles and Practices document). It is important to obtain multiple, representative samples for microcosm studies. A sufficient time should be allowed for an anaerobic population to grow and develop in the microcosm (several months to perhaps a year), just as would be expected for a field pilot test. Given that an appropriate microbial population is not evident in laboratory or field pilot testing, bioaugmentation is an alternative to achieve complete dechlorination at Type 3 sites (see Section 4.6 of the Principles and Practices document).

### **2.3.1.3 Potential for Biogeochemical Reduction**

Recent scientific literature (*e.g.*, Butler and Hayes, 1999; 2000; 2001) and data and observations from AFCEE field sites (*e.g.*, Lee *et al.*, 2003; Kennedy and Everett, 2001; Kennedy *et al.*, 2006) have uncovered another type of site where biogeochemical reduction contributes to the abiotic degradation of chlorinated solvents. Anaerobic conditions, natural or enhanced, and iron and sulfate in the subsurface can result in the formation of reactive metal sulfides. The significance of iron reduction in the degradation of petroleum hydrocarbons is covered in AFCEE’s AMIBA Protocol (AFCEE, 2000a). This body of work has since been extended into measuring and enhancing the activity of reactive metal sulfides at chlorinated solvent sites. The process has been stimulated in the field by the injection of sodium lactate and magnesium sulfate at Dover Air Force Base (AFB), Delaware (Kennedy *et al.*, 2006), and may be applied in a similar manner using edible oil as the organic substrate.

Sites with high concentrations of sulfate (perhaps 200 mg/L or more) are candidates for stimulating biogeochemical reduction of CAHs. This also is due to iron being a prevalent naturally-occurring metal in sedimentary deposits. Therefore, it is recommended that users

of this protocol consider the iron and sulfate reduction that results from substrate addition and the possibility that reactive metal sulfides may be produced in the subsurface as part of the edible oil process. An advantage of biogeochemical reduction is that intermediate dechlorination products (*e.g.*, *cis*-1,2-DCE and VC) are not produced.

### **2.3.2 Source Area and Plume Size**

An effective edible oil application requires uniform distribution of substrate throughout the treatment zone. For small source areas, injection of pure edible oil may be an effective approach to provide a long-lasting substrate to support anaerobic degradation processes over several years. Pure edible oil may be more difficult to distribute over large areas than soluble substrates or edible oil emulsions. For larger source areas, use of edible oil emulsions (perhaps with higher oil saturation) may allow more cost-effective treatment due to easier distribution in the subsurface (*e.g.*, a need for fewer injection points). For very large sources, it may be more cost-effective to contain the source using an edible oil emulsion in a biobarrier configuration. A cost-benefit analysis of the different approaches may be useful to determine the best approach for large source areas.

For large plumes, it may not be economically feasible to remediate the entire plume at one time due to the relatively high cost of installing injection wells. As in treating source areas, oil emulsions can be used to treat a larger radius of influence around each injection point. However, a more cost-effective approach may be to install biobarriers at several different transects perpendicular to groundwater flow along the axis of the plume. For example, if the biobarriers are spaced 1 to 2 years travel time apart, the entire plume may be treated by passage of contaminated groundwater through one or more biobarriers within as few as 5 years.

### **2.3.3 Depth to Groundwater**

Depth to water and the vertical thickness of the plume primarily impact the capital cost of drilling and delivering the substrate to the intended treatment zone. Where possible, installation of injection wells using direct-push equipment will result in a less costly installation. Direct-push equipment may also be used to inject edible oil products directly, which may further reduce the capital costs, but may also increase the time to perform.

The capital expense of installing multiple injection wells in deep settings (*e.g.*, greater than 100 feet below ground surface [bgs]), or across thick formations may inflate the cost of the injection process to a level not competitive with other remedial technologies. For example, pump-and-treat or recirculation methods may provide hydraulic control and remediation of a deep plume using only a few large-diameter recovery wells spaced at distances determined by appropriate groundwater models. Injection of edible oil substrate to form a barrier across a similar hydraulic front would likely require more wells on closer spacing than a pump-and-treat or recirculation design. In addition, there are practical limits to the maximum length of well screen across which a substrate can be uniformly injected; therefore, large saturated thicknesses may require multiple vertical injection screened intervals. Although the edible oil process may require more wells to implement, it should not be ruled out for this reason alone because the cost-savings over the life of the project may be significant without the O&M component associated with other technologies.

### 2.3.4 Heterogeneity and Hydraulic Conductivity

Heterogeneity and hydraulic conductivity are primary factors controlling effective distribution of substrate in the subsurface. Heterogeneous sites where hydraulic conductivity varies by orders of magnitudes over short distances present special challenges with respect to the achieving a uniform distribution of substrate. Any injected fluid will preferentially flow into more permeable materials. Thus, attention should be applied to understanding whether contaminants are localized in more or less permeable layers at the site.

Distribution of edible oil in more permeable materials may provide treatment as the majority of contaminant mass passes through these zones of higher flow, and may be an effective long-term containment approach. It is difficult to effectively distribute edible oil uniformly in lower permeability zones, particularly pure edible oil. If the majority of the contaminant mass has diffused into less permeable clays, silts, or bedrock, then long term mass reduction will be limited by slow diffusion of the contaminants out of these lower permeability layers.

In general, a hydraulic conductivity greater than 10 feet per day (ft/day), or approximately  $4 \times 10^{-3}$  centimeters per second (cm/sec), is best for effective distribution of edible oil or microemulsions out away from the point of injection (*e.g.*, Coulibaly and Borden, 2004). Microemulsions are recommended for formations with hydraulic conductivity less than 10 ft/day. It is generally infeasible to uniformly distribute an edible oil substrate in zones having a hydraulic conductivity less than 0.1 ft/day ( $4 \times 10^{-5}$  cm/sec), for example silt or silty clay.

Alternate injection techniques such as pneumatic fracturing have been used to inject neat oil or emulsified oil away from the injection points (*e.g.*, Site SS015 at Travis AFB, California; Parsons, 2004b). Fracturing techniques will result in a much less uniform oil distribution and may not bring the oil into direct contact with the contaminant. However, groundwater flow in these formations will be low, and diffusion is likely to be a predominant process for contaminant migration. While the timeframe for remediation of the entire aquifer volume may be on the order of several years or more, this can be an effective long term strategy for containment and attenuation of the contaminant plume.

### 2.3.5 Groundwater Flow

The subsurface hydrogeology must be considered in the site selection and design process, as inadequate characterization of the site hydrogeology can lead to system failure. Groundwater velocity, flow direction, and horizontal and vertical gradients will impact the effectiveness of an edible oil application. Excessively high rates of groundwater flow (greater than 5.0 ft/day) in a Type 2 or Type 3 site may require large amounts of substrate to overcome a large influx of competing electron acceptors migrating into the treatment zone. It may be impractical to maintain sufficiently reducing conditions in high-flow aquifers. Where groundwater flow rates are very low (less than 1.0 to 20 feet per year [ft/yr]), the timeframe for remediation may be extended due to reduced mixing of substrate and contaminant mass.

In very low flow environments there may be a lack of mixing of substrate and contaminant mass, where mixing is diffusion dominated. The application of an edible oil substrate may still be effective, but a longer remedial period may be required. In addition, low rates of groundwater flow may result in a build up of organic acids that may cause a pH drop due to

an inability to disperse the acids. A pH drop below 6 may result in incomplete dechlorination (*e.g.*, DCE stall) despite the presence of the appropriate dechlorinating microorganisms.

### 2.3.6 Competing Electron Acceptors

Characterizing the initial geochemical and oxidation-reduction conditions is useful to determine the prevailing terminal electron acceptor processes (TEAPs), and to evaluate the changes in oxidation-reduction conditions required for optimal reductive dechlorination to occur. In general, the highest rates and greatest extent of anaerobic reductive dechlorination occurs under sulfate-reducing and methanogenic conditions.

Prevailing redox conditions are largely a result of the amount of electron donors (organic carbon) and electron acceptors present. DO and nitrate must be depleted before iron-reducing, sulfate-reducing or methanogenic conditions can be induced. In general, USEPA (1998) suggests that DO less than 0.5 mg/L, nitrate less than 1.0 mg/L, sulfate less than 20 mg/L, and total organic carbon (TOC) greater than 20 mg/L are favorable for anaerobic dechlorination. In addition, ferrous iron and methane concentrations greater than 1.0 mg/L and 0.5 mg/L, respectively, are indicative of favorable conditions.

Excessive levels of competing electron acceptors such as DO, nitrate, or sulfate may require careful evaluation as to whether sufficient electron donor can be applied to overcome the competing demand. Existing guidance documents also suggest that high sulfate levels may be problematic for reductive dechlorination of CAHs. The anaerobic dechlorination scoring matrix in the USEPA (1998) protocol results in a lower score (lower potential for anaerobic dechlorination) if sulfate exceeds 20 mg/L; similar cautions are provided by Morse *et al.* (1998).

However, there is ample evidence in the literature for dechlorination of a wide variety of CAHs at sites containing elevated dissolved sulfate levels. The Interstate Technology Regulatory Council (ITRC, 1998), Devlin and Muller (1999), and Suthersan *et al.* (2002) report successful application of enhanced anaerobic bioremediation at sites containing up to 500 to 700 mg/L of sulfate. Complete anaerobic dechlorination has been stimulated at several high-sulfate Air Force sites including Altus AFB, Oklahoma, (sulfate up to 2,600 mg/L) (Appendix H.1) and Travis AFB, California (sulfate up to 5,400 mg/L) (Parsons, 2004b). Therefore, the presence of high sulfate concentrations does not preclude effective application of this technology.

Caution should be taken when applying the edible oil process at sites with high sulfate levels and very low iron concentrations in soil, since excessive levels of sulfides produced by reduction of sulfate may be inhibitory to anaerobic reductive dechlorination. This is not an issue at most sites (*e.g.*, those with appreciable amounts of iron in the soil) since sulfide rapidly reacts with iron and is removed from solution as an insoluble precipitate, for example iron monosulfide (FeS) or iron disulfide (FeS<sub>2</sub>). Further description of iron reduction, sulfate reduction, and the formation of iron sulfide minerals can be found in AFCEE (2000a).

Alternately, sites with high electron donor acceptor demand due to the presence of sulfate and ferric iron may be candidate sites for biogeochemical reduction where CAHs react with reduced FeS minerals precipitated under anaerobic conditions (Section 2.3.1.3). Edible oil applications to date have targeted sequential reductive dechlorination, but biogeochemical reduction may be a prevalent degradation reaction at sites such as Altus AFB, Oklahoma

(Appendix H.1; Kennedy and Everett, 2003). The practitioner should be aware of the potential for biogeochemical reduction when interpreting data from high iron and high sulfate sites (**Section 6**).

### **2.3.7 pH and Alkalinity**

A pH close to neutral (*i.e.*, 6.0 to 8.0) is the most conducive to the proliferation of healthy, diverse microbial populations. Low pH conditions (pH <6.0) are detrimental to sulfate-reducing, methanogenic, and dechlorinating bacteria (*e.g.*, Volkering and Pijls, 2004). Some fermentative organisms favor lower pH conditions and, therefore, will out-compete both sulfate-reducing and methanogenic bacteria in more acidic environments. This can result in the formation of undesirable byproducts of fermentation, such as ketones, alcohols, aldehydes and organic acids. Addition of edible oil may also lower pH due to formation of metabolic acids, particularly at sites with low groundwater flow rates where groundwater mixing is limited.

The buffering capacity of the aquifer should be evaluated (*e.g.*, alkalinity) and care should be taken not apply the substrate in excess of what is needed to develop appropriate geochemical conditions. Aquifer systems with lower buffering capacities are more susceptible to decreases in pH. Sites with pH outside of the 6.0 to 8.0 range may require more thorough biological screening (*e.g.*, using microcosm studies) to evaluate the effect of pH manipulation on the existing dechlorinating microbial populations.

In cases of low pH (<6.0) or low alkalinity (<300 mg/L), pH buffering should be implemented during injection to raise and/or neutralize pH against further decreases. Common basic salts such as sodium bicarbonate may be used as a buffering agent. Buffering agents should be applied at the time of injection, as it is not cost-effective nor very feasible to buffer after injection due to the cost of remobilization and reinjection.

## **2.4 PROCEEDING WITH THE EDIBLE OIL PROCESS**

After the preliminary screening is complete, a preliminary conceptual design for remediation of the site should be developed (**Figure 1.5**), following procedures described in **Section 3** and **Section 4**. The cost and performance of the selected approach can then be compared against other treatment technology alternatives. If application of the edible oil process appears to be the most reasonable approach, then a pilot test of this process may be implemented. The pilot test can then be used to revise the preliminary conceptual design to improve performance and reduce costs. Before proceeding with a pilot test or full-scale project, users are urged to review the detailed description of the edible oil process provided in **Appendix D**.

## SECTION 3

### PILOT TEST PLANNING, IMPLEMENTATION, AND MONITORING

Implementing a pilot test of enhanced *in situ* anaerobic bioremediation using edible oil requires careful consideration of site conditions, remedial objectives, design alternatives, and field methods. The natural variation in lithology, hydrogeology, geochemistry, and microbial ecology of aquifer systems makes each site contaminated with chlorinated solvents different and unique. The practice of enhanced anaerobic bioremediation of chlorinated compounds continues to evolve. For sites where the technology can not be readily applied with confidence at the full-scale based on site-specific limitations, some form of field or bench-scale testing is strongly recommended.

*The natural variation in subsurface conditions makes each site contaminated with chlorinated solvents different and unique. For sites where the edible oil process can not be readily applied with confidence at the full-scale, some form of field pilot test is strongly recommended.*

Pilot tests are a cost-effective way to demonstrate the utility of using edible oil for enhanced *in situ* anaerobic bioremediation. The cost of field testing can be recovered by the optimization and greater efficiency of a full-scale design based on pilot test performance data. Conducted in a careful and thorough manner, pilot testing provides the performance basis required for full-scale implementation of enhanced bioremediation of chlorinated compounds using edible oil. Advantages of the technology can be exploited in this process, while avoiding or mitigating potential adverse impacts.

This section describes the procedures and protocols required for planning and implementing a pilot test, including baseline characterization, types of pilot tests, development of site-specific test plans, and process monitoring. Methods to implement a pilot test (*e.g.*, injection techniques) are described in greater detail in [Section 5](#). Methods and procedures for evaluating pilot test results are discussed in [Section 6](#).

#### 3.1 DEFINING PILOT TEST OBJECTIVES

The primary objectives of an enhanced anaerobic bioremediation pilot test using edible oil are to 1) confirm if this technology is suitable to achieve remedial goals for the site, and 2) determine critical design parameters required for a successful full-scale implementation. These objectives are by nature site-specific, and it is necessary to determine whether enhanced bioremediation using edible oil is the most reasonable approach at the site relative to other remedial technologies (*e.g.*, monitored natural attenuation [MNA], oxidation strategies, groundwater extraction).



In order to define the pilot test objectives, a preliminary conceptual design for a potential full-scale remediation system should be developed first. Once a preliminary design has been developed and remediation goals have been established, data quality objectives (DQOs) can be defined. DQOs may include degradation of contaminant concentrations to specified compliance levels (*e.g.*, MCLs) or achieving degradation rates that are deemed sufficient to contain or attenuate the contaminant plume within a reasonable timeframe. DQOs may also include limits to the accumulation of intermediate dechlorination products (*e.g.*, VC) or limits on degradation of secondary water quality (*e.g.*, dissolved metals). For pilot tests, it is only necessary to achieve DQOs within the immediate treatment zone, and sufficient time (perhaps 1 to 3 years) may be required for the treatment system to demonstrate its effectiveness over the typical life-cycle of an enhanced anaerobic bioremediation application.

A second objective of a pilot test is to determine critical design criteria and to evaluate potential adverse secondary impacts to groundwater associated with enhanced anaerobic bioremediation using edible oil. These include, but are not limited to, the following:

- **Injection Methodology and Radius of Influence.** Determine an appropriate injection method and well spacing that achieves the desired injection rate and radius of influence (ROI) (see [Section 3.4.1](#)).
- **Impacts to Hydrogeology.** Determine whether addition of edible oil imparts an undesirable reduction in aquifer permeability. This may require modification of the substrate amendment (*e.g.*, reduction in residual oil saturation or emulsion droplet size) (see [Section 3.4.2](#)).
- **Contaminant Biodegradation Rates and Required Residence Time.** Determine contaminant degradation rates and use this information to estimate the residence time required for contaminant biodegradation in a source area or biobarrier treatment zone (see [Section 4](#)).
- **Substrate Requirements.** Determine how much substrate is required to deplete alternative electron acceptors and sustain an anaerobic reactive zone conducive to reductive dechlorination of CAHs (see [Section 4](#) and [Appendix G](#)).
- **Secondary Impacts.** While anaerobic dechlorination may be effective in degrading chlorinated solvents, there is some potential for secondary degradation of groundwater quality or generation of noxious gases to occur (see [Section 2.2](#)). These changes are not easily reversed and it may take many years for the effects of the substrate addition to diminish. These potential impacts should be evaluated during the course of the pilot test, particularly for drinking water aquifers.

Proper planning and pilot test design are required to optimize system performance in order to achieve the pilot test DQOs and to mitigate potential impacts to site hydrogeology and groundwater quality. The next section describes how pilot test plans are developed.

## 3.2 DEVELOPMENT OF A SITE-SPECIFIC TEST PLAN

A site-specific test plan is required for successful implementation of enhanced *in situ* anaerobic bioremediation using edible oil. The test plan should review and identify site remedial objectives, review and screen site conditions for enhanced anaerobic bioremediation,

describe the proposed technical approach, provide detail on system design and construction, and describe the monitoring protocols to be used to evaluate the test. Elements of a site-specific test plan should include, but not be limited to, the following:

- **Introduction:** Problem statement, pilot test objectives, and a brief description of the scope of work and technology being applied. DQOs should be established before proceeding with pilot test design.
- **Site-Specific Data Review:** Operational history, regulatory status, groundwater use, hydrogeology, and nature and extent of contamination.
- **Preliminary Screening for Enhanced Anaerobic Bioremediation:** Distribution of parent and dechlorination products, groundwater geochemistry, hydrogeological limitations, and suitability for enhanced bioremediation. To include potential for both biotic reductive dechlorination and biogeochemical reduction processes.
- **Proposed Technical Approach:** System design including configuration, injection strategy, substrate calculations, and monitoring program. Provide contingencies for potential problems. To the extent possible, pilot test injection procedures should be similar to those being considered for the full-scale remediation system.
- **Field Program:** Protocols for baseline monitoring, system installation, edible oil injection, process monitoring, and disposal of investigation-derived waste.
- **Proposed Project Schedule and Project Contacts:** Schedule for field program and reporting, and a list of pertinent project contacts and personnel.
- **Health and Safety Plan.** Include site-specific health and safety plan including contingencies and directions to local emergency care. Health and safety considerations should address traffic in the work areas, utility clearances, spill containment measures, and procedures for working with drilling equipment and high-pressure injection systems.
- **Access Considerations.** The test plan should identify site access requirements and potential impacts to site operations and infrastructure. For DoD facilities, personnel security passes may be required and should be procured in advance.

Examples of site-specific test plans can be found on the AFCEE Tech Transfer web site:

<http://www.afcee.brooks.af.mil/products/techtrans/bioremediation/BIOREMresources.asp>

The site includes test plans for edible oil applications at several sites, including: Hickam AFB, Hawaii; Arnold AFB, Tennessee; Tinker AFB, Oklahoma; Former Carswell AFB, Texas; and Travis AFB, California. Potentially, more test plans will be added as the web site is updated.

### 3.3 PILOT TEST CONFIGURATIONS

Pilot test configurations using edible oil for enhanced *in situ* anaerobic bioremediation may range from single well push-pull tests to multiple well injection tests. In some cases, a pilot test may be configured to achieve an interim remedial objective such as source or “hot spot” reduction. The pilot test work plan should detail and describe the protocols and procedures to

be followed when constructing the injection system, injecting the edible oil, and for baseline and performance monitoring. Changes to the pilot protocol should be noted in order to replicate or modify the field program accordingly for future full-scale operations. The following sections describe the most common pilot test types: single well push-pull tests and multiple well injection tests.

### 3.3.1 Single Well Push-Pull Injection Tests

Single well push-pull methods may be used as a simple pilot test to evaluate pre-design parameters for implementing enhanced *in situ* anaerobic bioremediation using edible oil. Examples of push-pull tests for aerobic cometabolism include Kim *et al.*, 2004 and 2006 (*e.g.*, see <http://web/engr.oregonstate.edu/~istok/grl-manuscripts.htm>). In this approach, a known volume of groundwater is extracted from the well, amended with an edible oil emulsion, and re-injected (pushed) into the aquifer. The treated well and a parallel untreated well are monitored periodically to evaluate contaminant biodegradation. Initial and final aquifer tests (step draw down tests or slug tests) may be performed to evaluate loss of permeability due to bioclogging. This would help assess whether a full-scale application would be impacted by loss of hydraulic conductivity

#### 3.3.1.1 Single-Stage Push-Pull Test

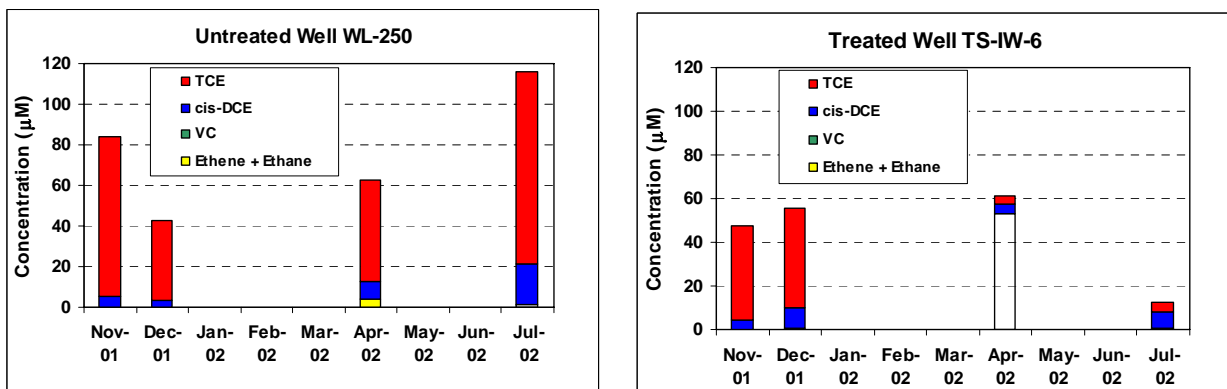
A single stage push-pull test consist of a single extraction and reinjection (the “push”) of groundwater amended with substrate and tracers. The water is then sampled (“pulled”) over time to evaluate the impacts of adding the edible oil substrate. Typical test procedures for a single-stage push-pull test are summarized below.

1. Identify two wells for use in the test. These wells can be existing monitoring wells that are no longer needed for compliance monitoring or new wells that are installed specifically for the pilot test. Ideally, these two wells should be reasonably close together and have generally similar geochemical characteristics. In general, well screens should be 10 feet or less in length and screened across the horizon targeted for remediation. If one well is upgradient of the other, the upgradient well should be designated as the control well and the downgradient well used for the injection and monitoring of the impacts of edible oil injection.
2. Extract groundwater from the test well at a sustainable rate (*e.g.*, less than a foot of drawdown), and collect in a single storage tank and sample for contaminant and geochemical characteristics. It is desirable to extract and re-inject at least 100 gallons of groundwater per foot of well screen. Assuming an effective porosity of 20 percent, this will provide a 4.6-foot ROI around the well screen. For a 10-foot well screen, a suitable approach would be to extract 1,000 gallons of groundwater into a 1,500-gallon tank.
3. Add the edible oil emulsion and a conservative tracer to the groundwater and mix. See [Section 5.2](#) for preparation and injection of an edible oil emulsion. Given the small quantities of material required for a single well test, it may be easier to purchase a pre-mixed emulsion product that can be readily dispersed into the mixing tank. In previous studies, 250 to 500 mg/L of sodium bromide (NaBr) has been adequate to act as a tracer to provide a clear signal above background bromide concentrations and interfering anions. The amount of emulsion to inject will depend on the formation properties and can be calculated using procedures presented in [Section 4.2](#) and [Appendix G](#). For a typical silty or clayey sand, 0.35 pounds of

emulsified oil per gallon of injection water should be sufficient. The emulsion/tracer mixer is then injected into the test well at a rate similar to that used for extraction. During the injection process, injection pressure, flow rate and general operating conditions should be monitored (Section 5.1.2).

- Groundwater from the test and control well should then be sampled periodically using low-flow techniques for the target contaminants and biogeochemical parameters (Section 6). A typical monitoring schedule would be to sample at 1, 3, 6, 9, and 12 months after oil injection. Changes in concentrations of the contaminant, organic carbon, and alternate electron acceptors over time are used to estimate rates of substrate utilization and contaminant degradation. Measurement of conservative tracers can be used to normalize the data to account for dilution early in the test, and comparison of concentrations to the control well can be used to account for seasonal or temporal trends in contaminant concentrations in the test area.

Figure 3.1 shows results of a single well push-pull test conducted at Altus AFB OU-1 from 2001 to 2002. In November 2001, the test well (TS-IW-6) and a parallel control well (WL-250) were monitored to establish background conditions prior to substrate addition. In December 2001, well TS-IW-6 was then treated with two drums of a dilute soybean oil-in-water emulsion followed by two drums of groundwater amended with bromide to push the substrate into the formation. The soybean oil emulsion was designed to be sorbed or entrapped within the formation, providing a long-term source of slow-release organic substrate to support reductive dechlorination. WL-250 is a nearby well that was not treated and was monitored as a control. Treatment of well TS-IW-6 with emulsified soybean oil enhanced anaerobic biodegradation processes in the immediate vicinity of TS-IW-6, stimulating complete dechlorination of TCE to ethene and ethane. In comparison, there was no significant change in contaminant concentrations in the untreated control well.



**Figure 3.1 Changes in Chlorinated Ethenes in Untreated Control Well WL-250 and Emulsion Treated Well TS-IW-6 at OU-1, Altus AFB, Oklahoma**

This relatively simple single stage push-pull test provided clear evidence that 1) edible oil addition to the aquifer at the OU-1 site could stimulate reductive dechlorination of TCE, and 2) addition of a bioaugmentation culture was not needed to stimulate complete dechlorination to ethene and ethane. Because the edible oil attached to the aquifer solids, it provided a long-lasting substrate (minimum of 8 months based on monitoring) for reductive dechlorination

and did not migrate downgradient with groundwater flow. By contrast, more soluble and readily biodegradable substrates such as lactate could be transported away from the well with the groundwater flow. Partitioning of chlorinated solvents to the oil did not substantially interfere with interpretation of the test results since a large portion of the original TCE was recovered as ethene and ethane during the April 2002 sampling.

While the single well push-pull test can generate very useful results, there are some limitations to this method.

1. In areas with groundwater velocity in excess of 0.5 ft/day, the small radius of influence around the injection well may not provide sufficient contact time between the flowing groundwater and the edible oil for extensive contaminant biodegradation. This may also be a problem at sites with high levels of competing electron acceptors (*e.g.*, sulfate > 500 mg/L).
2. Conditions can arise wherein degradation products are not sufficiently persistent to provide corroborating evidence that biodegradation is the primary removal mechanism over physical partitioning of contaminants into the edible oil. The complete absence of detectable concentrations of breakdown products is considered to be rare, especially shortly after (*e.g.*, 3 to 6 months) edible oil injection. In addition, abiotic degradation processes generally do not produce intermediate chlorinated degradation products. Abiotic degradation may produce acetylene, but it may be short lived and therefore not detected. Other lines of evidence (*e.g.*, contaminant concentrations in edible oil samples, chloride concentrations greater than three times background levels, or use of conservative or non-conservative tracers) may be required to further evaluate degradation versus partitioning. Stable carbon isotope analysis is another tool that may be used to differentiate between partitioning and biodegradation because biodegradation creates changes in the relative fractions of carbon isotopes while partitioning does not. This is less of an issue when intermediate dechlorination products are produced at detectable concentrations (*e.g.*, *cis*-1,2-DCE, VC, and ethene).
3. In many states, an Underground Injection Control (UIC) permit or equivalent may be required prior to any injection. This can substantially increase the time and cost of the push-pull test.
4. Single well push-pull tests may provide limited information about the rates of biodegradation that can be achieved.

For sites where subsurface conditions vary within the impacted aquifer (*e.g.*, lithology or geochemistry), multiple single well tests may be conducted to gain a better understanding of the degradation that can be achieved site-wide. If a more detailed study with a greater level of confidence is desired, a two-stage push-pull test ([Section 3.3.1.2](#)) or multi-well pilot test ([Section 3.3.2](#)) may be considered.

### **3.3.1.2 Two-Stage Push-Pull Test**

In certain cases, it may be useful to conduct a two-stage push pull test. In the first stage, the test well is treated with an edible oil substrate as described in [Section 3.3.1.1](#) and highly anaerobic conditions are allowed to develop (on the order of 2 to 6 months). Once anaerobic

conditions have been established, a second stage extraction/injection is conducted over a shorter period of time.

In the second stage, groundwater is extracted, characterized, spiked with contaminants, amended with tracers (*e.g.*, sodium bromide or sodium iodide), and reinjected. Where spiking with a regulated compound is prohibitive, contaminant surrogates may be considered as an alternative (*e.g.*, trichlorofluoroethene; see Hageman *et al.*, 2001). The groundwater is then periodically extracted over a period of a few days to a week and analyzed as described above in the single-stage push-pull test. The advantages of a two-stage push-pull test are that the system is allowed to acclimatize and become highly anaerobic before the contaminant degradation is measured. Contaminant degradation rates under this scenario should be optimal, sufficient to observe the effectiveness of substrate addition over a much shorter period of time. These rates may more accurately reflect degradation rates that may be achieved for long-term performance of a full-scale application. It should be noted that the two-stage push-pull test is subject to many of the same limitations as previously described for the single-stage push-pull test.

### **3.3.2 Multi-Well Injection Tests**

In some cases it will be appropriate to conduct larger scale pilot tests using a series of injection wells or direct-push well points configured in a grid or linear biobarrier configuration. Multi-injection well pilot tests are utilized to develop a larger reaction zone than a single well test. Monitoring of the injection zone and the effects on downgradient water quality can be observed by sampling a monitoring well network over time.

An example of a multi-well pilot test in a barrier configuration at Altus AFB is included in [Appendix H](#). Multi-well pilot test are typically operated for periods of 12 to 24 months to allow for microbial acclimation to anaerobic conditions to fully evaluate the effectiveness of the edible oil process.

Benefits of a multi-well pilot test include the following:

- Closer representation of full-scale system performance and costs.
- The establishment of a larger edible oil injection and reaction zone reduces the probability that heterogeneity or preferential flow paths could cause treated groundwater to bypass downgradient monitoring wells.
- Larger monitoring network providing evaluation of the downgradient extent of the reaction zone and impacts on downgradient water quality.
- Monitoring results will be representative of a greater aquifer zone (*i.e.*, not limited to a single well point that may or may not be representative of aquifer conditions).

### **3.4 MONITORING DURING THE INJECTION PROCESS**

Monitoring of the injection of edible oil during a pilot test is required to optimize the injection system and to determine critical design parameters for full-scale application. Operating parameters that should be documented include the following:

- Substrate preparation including a description of the mixing system; measured concentrations of oil, water and amendments in the substrate mixture; and emulsion stability (for emulsions).
- Injection pressures throughout the system and at individual well heads, and the corresponding flow rates.
- Safety issues including failure of well seals, or leaks or failure in the injection system.
- Significant injection thresholds. For example, minimum pressure required to obtain a desired flow rate, or a drop in pressure and increase in flow rate indicating fracturing of the formation.
- Amount of substrate and water push (if used) injected per injection point.
- Substrate breakthrough at monitoring points as an indicator of the ROI or the presence of preferential flow paths (*i.e.*, breakthrough beyond the theoretical ROI).

Parameters used to measure breakthrough should be selected based on the knowledge that the injected fluid displays a significantly different profile than native ground water. In addition, it is advantageous if these parameters can be measured in the field. Example “breakthrough” parameters may include specific conductivity, visual or spectrophotometric (fluorescence) due to oil emulsion or dye compounds, and tracers (*e.g.*, bromide or iodide). Field observations may be used to optimize the injection process during the pilot test, as well as providing data for future full-scale operations.

### **3.4.1 Radius of Influence Evaluation**

The ROI of the injected edible oil substrate includes both the physical distribution of the edible oil and the migration of dissolved substrate constituents, including highly soluble metabolic acids produced by degradation of the edible oil. Methods used to evaluate the ROI include groundwater and soil sampling, and the use of groundwater tracers.

Several visual and analytical methods may be employed to determine the ROI of edible oil injected into the subsurface. Tracer compounds may be used to determine the distribution of oil in the subsurface and the radius or zone of influence. Tracers fall into two categories, water soluble and oil soluble, as discussed in the following sections.

#### **3.4.1.1 Water Soluble Groundwater Tracers**

If properly implemented, tracers in the water introduced immediately before, during, or after oil injection can provide valuable information on the following:

- The direction of movement and seepage velocity of groundwater that has been in contact with the oil.
- The effects of dilution or degradation of the organic substrate with groundwater migration.
- The impacts of edible oil on dispersivity and hydraulic conductivity.

- Facilitate the identification of preferential flow paths and asymmetric oil substrate distribution profiles.

Knowing the direction of movement and seepage velocity of the groundwater that has been in contact with edible oil is important because it will provide information on the potential treatment area and behavior of the organic carbon introduced into the groundwater.

In order to trace groundwater migrating from the immediate vicinity of the injection wells (*i.e.*, zone of influence), water used for injection can be amended with a conservative tracer such as sodium bromide or sodium iodide. Caution should be exercised when there is a potential for surface water discharge, as bromide or iodide in surface water may be regulated in some states.

Bromide has a low adsorptive potential and migrates at approximately the rate of advective groundwater flow, and can be tracked in groundwater after injection to estimate advective groundwater flow in the treatment area. Note that the bromide will be injected out, away from the well screen during injection. The estimate of groundwater flow may be artificially high if the migration of the tracer during injection is not accounted for. In other words, consider the distance in the downgradient direction that the bromide was injected to when calculating the distance at which the bromide is observed to migrate over time.

The migration of organic carbon in groundwater (from dissolution or biodegradation of the edible oil) also can be measured as TOC (unfiltered samples) or dissolved organic carbon (DOC, filtered samples) at monitoring well locations. TOC is typically used with edible oil applications because the oil may migrate as colloids or small droplets suspended in water. Thus, TOC can be tracked and used to determine the zone of influence of the edible oil. Edible oil is a non-conservative tracer as organic carbon is retarded (relative to migration of a conservative tracer such as bromide) due to its higher adsorptive potential, and is also subject to biodegradation.

#### **3.4.1.2 Oil Soluble Tracers**

One method to directly trace and to determine the distribution of oil in the subsurface is to use direct-push technology with laser-induced fluorescence (LIF). The cone-penetrometer testing (CPT) LIF system used by the United States Army Corp of Engineers (USACE) has a 0.25-inch sapphire window in the side of the cone that allows a laser to scan the soil for fluorescent compounds as the CPT rod pushes through soil.

Oil soluble fluorescent dyes are available to enhance the ability of LIF technology to detect the edible oil in the subsurface. Chromatint fluorescent (oil soluble) dye is a commercially available dye that was developed to track releases from leaking fuel tanks and distribution lines, and has been approved in some applications for subsurface tracing in groundwater aquifers. This dye can be added and mixed into the edible oil prior to injection to enhance the fluorescence properties of the edible oil.

Another commercial oil-soluble dye, Oil-Red-O, has the benefit of increasing the visual detection of the oil or an emulsion, useful for determining if oil or an emulsion have migrated to nearby monitoring locations, or useful to determine if oil is present in soil cores. In all cases, use of these dyes must be approved for injection into the subsurface by applicable regulatory authorities.



### **3.4.1.3 Soil Analysis for Determining Substrate Distribution**

Soil samples also may be collected to determine the radius of influence. Soils may be analyzed for TOC by EPA Method 415.1 or SW9060 modified as an indicator of the amount of substrate present in the aquifer matrix. Soil samples collected by direct-push techniques may be sufficient to evaluate the effective distribution of the edible oil emulsion in the subsurface. This approach was used with mixed success at the Charleston Naval Weapons Station as a means of identifying residual concentrations of TOC in the emulsion injection zone. Because of the variability of naturally-occurring organic matter in soil, it is important to collect a representative data set for the range of sediments present before injection in order to see changes in TOC post-injection.

Alternately, because the long-chain organic compounds present in edible oil are detected by analyses for petroleum hydrocarbons, soil samples may be analyzed for total petroleum hydrocarbons (TPH) by EPA Method 418.1 or simple field immunoassay methods such as the PetroFlag<sup>®</sup> test. Another method that may be used is to analyze for oil and grease by EPA Methods E413.1 or SW9070. These methods may be used as a semi-quantitative indicator of the amount of oil substrate present.

### **3.4.2 Effect of Oil Injection on Formation Permeability**

Formation permeability may change due to the presence of residual saturations of edible oil and biomass growth. Aquifer tests such as slug tests or well drawdown (specific capacity) tests (*e.g.*, Wilson *et al.*, 1997) should be conducted in select injection and monitoring wells within the treatment area both before and after injection, and periodically during process monitoring. Comparative values and estimates of hydraulic conductivity before and after oil injection can be used to determine whether substrate addition has had an impact on aquifer permeability. It should be noted that bio-clogging of well screens between the interface of the aquifer matrix and the open borehole may cause an apparent decrease in hydraulic conductivity. Therefore, caution should be used in interpreting these results. If substantial biomass is visualized in well samples and/or apparent reductions in hydraulic conductivity are observed, well surging may identify if the bio-clogging is primarily localized on the well screen and/or gravel pack. In extreme cases, a non-reactive tracer test may be conducted to evaluate the potential for flow bypassing around the treatment zone.

Advances in the manufacture of oil emulsions further minimize the potential of physical clogging that may be experienced with pure edible oil applications. Emulsions with uniformly small droplet sizes can readily pass through filter sand in the well annular space and into the formation. Biofouling as a result of luxuriant microbial growth is also minimized by use of oil as the primary substrate. Edible oil is slowly soluble and fermentation is generally slower than for readily degraded soluble substrates.

## **3.5 MONITORING NETWORKS**

Monitoring networks are necessary to document the performance of the enhanced bioremediation system. Monitoring network design includes consideration of the location and depths of the groundwater monitoring wells, use and placement of soil gas monitoring points, and frequency of monitoring events.

### 3.5.1 Number and Location of Monitoring Points

Groundwater sampling is conducted to determine the concentrations and distribution of contaminants, daughter products, groundwater geochemical parameters, and specialized microbial parameters (*e.g.*, *Dehalococcoides* species). Groundwater samples may be obtained from monitoring wells or with point-source sampling devices such as a Geoprobe<sup>®</sup>, Hydropunch<sup>®</sup>, or CPT. All groundwater samples should be collected, handled, and disposed of in accordance with local, state, and federal guidelines.

Injection and monitoring wells should target intervals of elevated contaminant concentrations. Performance monitoring wells should be located both upgradient of the reaction zone and at locations within and downgradient of the reaction zone parallel to the direction of groundwater flow. These wells are used to monitor changes in groundwater chemistry over time along the groundwater flow path through the treatment area. Changes in contaminant concentrations allows estimation of biodegradation rate constants. Cross-gradient well locations are useful to define the lateral extent of treatment and provide for greater accuracy in mapping hydraulic gradients.

Consideration should be given to groundwater seepage velocity and the desired frequency of performance monitoring when determining monitoring locations and spacing. In general, the screened interval of the monitoring wells should be similar to the injection interval. It is beneficial to have at least one monitoring location within the injection area screened at multiple depths to determine vertical hydraulic gradients and the potential for vertical migration of dissolved substrate. Downgradient monitoring locations screened at deeper or shallower depths may be necessary to monitor the downgradient contaminant flow path in the presence of vertical gradients.

The monitoring well network should also be configured to allow the measurement of radius of influence of the injected oil and the effective treatment zone. The radius of influence of the injected substrate at each injection well can be estimated given 1) the volume of substrate mixture injected, 2) the length of the injection screen, 3) an assumed effective porosity of the aquifer matrix, and 4) an assumed uniform horizontal and radial distribution of substrate away from the injection well screen.

The effective pore volume in a cylindrical volume of the aquifer is:

$$PV = \pi r^2 h n_e \quad (3-1)$$

Where: PV = pore volume (*e.g.*, cubic feet)

$\pi$  = pi (3.14) (unit less)

r = ROI (*e.g.*, feet)

h = vertical height of the treatment zone (*e.g.*, feet)

$n_e$  = effective porosity (unit less)

The ROI can be calculated by the following:

$$ROI \text{ (feet)} = \text{SQRT}((PV)/(\pi h n_e)) \quad (3-2)$$

Conversion of PV in cubic feet to gallons (the common unit of measure for substrate volumes) can be calculated using the following conversion factor:

$$PV \text{ (cubic feet)} * 7.48 \text{ (gallons per cubic foot)} = PV \text{ (gallons)} \quad (3-3)$$

Example calculations shown in **Table 3.1** show how the ROI changes based on differing screen lengths for an injection well. The calculations are also useful in selecting monitoring well locations radially outward from injection wells based upon the estimated thickness of the target treatment interval and the injection volume. At minimum, two monitoring wells should be placed within the estimated radius of substrate distribution. This information is also useful in evaluating if injected substrate moved into the aquifer in a uniform and symmetric pattern or not. The addition of a conservative tracer like sodium bromide is also recommended to evaluate substrate distribution patterns.

**Table 3.1**  
**Example Calculations of the Dimensions of the Injectant Distribution Zone**

<b>Injected Volume per Well (gallons)</b>	<b>Effective Porosity</b>	<b>Injection Well Screened Interval (h in feet)</b>	<b>Volume of Aquifer Affected (gallons)</b>	<b>Radius of Influence (feet)</b>
5,000	0.25	5.0	20,000	13
5,000	0.25	10.0	20,000	9.2
5,000	0.25	15.0	20,000	7.5

The appropriate locations of treatment zone and downgradient monitoring wells are best verified by predicting the combined contaminant and geochemical profile expected at that location, and then comparing it to the observed profile. In general, all treatment zone and downgradient wells should ideally display differing, yet predictable, anaerobic geochemical profiles and should contain mobile reagents or tracers present in the injected fluid (*e.g.*, sodium or bromide) or generated as a result of microbial activities (*e.g.*, Fe(II), methane, alkalinity, or chloride). An unexpected profile may suggest that well placement or selected well screened intervals are not optimal or that systematic sampling and/or analysis errors may exist.

Soil gas monitoring networks can be used to evaluate the formation and persistence of biogenic gases (*e.g.*, methane, hydrogen sulfide) as a result of enhanced anaerobic microbial activity. Soil gas points only penetrate the vadose zone and may be useful when a shallow groundwater aquifer is being treated. In deep groundwater treatment designs, there is little likelihood that gases generated in the deep aquifer will migrate vertically with any measurable concentration to the overlying soil. Biogenic gases like methane and hydrogen sulfide are readily biodegraded in the presence of oxygen. Natural oxygen levels in shallower soils are often sufficient to degrade these gases before discharge to subsurface structure or the surface. A landfill gas detector can be used to monitor soil gas samples for parameters such as carbon monoxide, hydrogen sulfide, oxygen, and methane. Soil gas monitoring networks can also detect volatile contaminants, such as dechlorination products from incomplete reductive dechlorination, and these may also be degraded in the vadose zone.

### 3.5.2 Analysis of Substrate Distribution

Given the ever-present heterogeneity of the subsurface, the control and measurement of the distribution of injected fluids is always challenging. The uniform distribution of organic substrate throughout the target treatment zone is a critical factor. Thus, a monitoring strategy should be developed to measure substrate distribution. The evaluation of substrate distribution should incorporate multiple approaches. These approaches are based on the concept that the injected fluid has different chemical characteristics than the site groundwater. Furthermore, tracer compounds can be added to the aqueous or oil phases to improve detection capabilities. **Table 3.2** outlines a variety of techniques that have been used to evaluate substrate distribution and longevity.

**Table 3.2**  
**Methods to Measure Distribution of Organic Substrates**

Measured Parameter	Detection Approach	Data Interpretation
Oil emulsion	Periodic visual inspection of groundwater in monitoring wells	The appearance of visible emulsion in a well indicates breakthrough in that region. The time versus distance relationship indicates whether uniform or channelized flow occurred.
Water soluble dyes and tracers ( <i>e.g.</i> , fluorescein, sodium bromide, sodium iodide)	Visual dye inspections or field meter meters (colorimetric, ion-selective, conductivity); low flow purging of adjacent monitoring and flow-through cells can be used to develop breakthrough curves.	The observed presence of water soluble dyes indicates that the monitoring point is within the flow of injected fluids. The presence or absence of injected oil emulsion indicates whether emulsion is being “filtered out” or effectively distributed.
Dissolved total organic carbon or tracer compounds	Laboratory chemical analysis	Same as visual and tracer methods above
Oily phase	Direct push with laser-induced fluorescence or direct soil sampling	Laser-induced fluorescence or direct soil sampling for total organic carbon/oil & grease methods can characterize the 3-dimensional configuration of substrate distribution.
Geochemical indicators ( <i>e.g.</i> , dissolved oxygen, redox, nitrate, ferrous iron, sulfate, methane, etc.)	Field meters and laboratory analyses can be used to determine if monitoring location is within or downgradient of substrate distribution zone.	These techniques are indirect and require that enough time has passed to allow for biodegradation to occur. Differentiating zones that are directly within the substrate distribution zone versus areas immediately downgradient may not be possible.
Changes in hydraulic conductivity	Slug tests or specific capacity tests before and after injection. Pre- and post-injection borehole flow meter surveys.	Poor distribution often correlates with significant or potential undesirable reduction in hydraulic conductivity. More moderate reductions may provide a useful indicator of substrate distribution as well as provide assurance that unacceptable clogging has not occurred.
Electrical conductivity	Direct push rigs with electrical conductivity probes	The oily phase deposited in the subsurface can lower the electrical conductivity of the receiving soils. The addition of salts to the aqueous phase of the injectant could facilitate detection via electrical conductivity. These tests can be conducted before, during, or at various times after injection to test for the presence of oil or the persistence of higher conductivity salts.

### 3.5.3 Monitoring Frequency

Process monitoring sampling frequency will depend on many factors including, but not limited to: well spacing, groundwater seepage velocity, aquifer heterogeneity, and the efficacy of biodegradation. It is important to ensure that enough time has passed to see changes in groundwater geochemistry and changes in the ratios of parent compound(s) to dechlorination products.

A slow-release edible oil system typically does not require an operational component over the first year or two. Additional injections may be necessary, based on site-specific conditions related to the rate of degradation, groundwater velocity, and time-frame for remediation. These injections will usually not be frequent, perhaps on the order of every 2 to 3 years. Therefore, quarterly to semi-annual performance monitoring is sufficient to document performance and to determine the need for additional injections.

Typical lag times to stimulate measurable increases in the rate of degradation of chlorinated ethenes (*e.g.*, PCE and TCE to DCE, and DCE to VC to ethene) may be on the order of weeks to 12 months or more depending on the initial redox conditions in the aquifer. Anaerobic aquifers typically require shorter acclimation periods than aerobic aquifers. In these cases, frequent sampling on the order of weeks to a few months may yield unsatisfactory early results and an unjustified lack of confidence in the effectiveness of the system.

## 3.6 PERFORMANCE MONITORING PROTOCOLS

Biodegradation of organic compounds stimulated by substrate addition brings about measurable changes in the chemistry of groundwater in the treated area. By measuring these changes, it is possible to document and quantitatively evaluate the effect of adding edible oil to the subsurface to enhance anaerobic biodegradation at a site. Guidance on evaluating these protocols is included in the following sections of this chapter, and can also be found in various publications on MNA and enhanced bioremediation including AFCEE *et al.* (2004), USEPA (1998), National Academy of Sciences (2000), ITRC (1999), and Wiedemeier *et al.* (1999). Analytical protocols for soil, soil gas, and groundwater sample analysis are described in Table F.1 of [Appendix F](#), and analytical methods and data quality objectives are described in Table F.2.

Ongoing monitoring of key contaminant and biogeochemical characteristics of the site is critical to evaluating the effectiveness of the system to meet remedial objectives. Performance monitoring should typically follow the protocol used for baseline geochemical characterization that was selected for the site. Primary groundwater parameters that should be sampled regularly for process monitoring include CAHs and degradation products, biogeochemical indicators of redox conditions, and the strength and distribution of organic substrate. Samples of free phase edible oil can be analyzed for CAHs using a modification of USEPA Method SW8260B to determine the potential for sequestration of CAHs into the edible oil.

Certain monitoring parameters may be dropped if they provide little or no useful information. For example, denitrification will not be a significant redox reaction for a site with naturally low levels of nitrate (*e.g.*, less than 1 mg/L). Therefore, continued monitoring of this parameter yields little information on the predominant redox reactions that are

occurring. Caution is advised for regulated parameters that may be expected to change with a lowering of the redox potential. For example, it may take several months for the system to evolve to reducing conditions that may result in elevated levels of metals. In this case, groundwater monitoring for selected metals should not be discontinued if initial metal concentrations are low under initial aerobic conditions.

Performance monitoring may also include optional diagnostic analyses. Molecular biological tools (MBTs) may be used to screen for the presence of *Dehalococcoides* species ([Section 3.6.4](#)). Isotope fractionation may distinguish between partitioning of chlorinated compounds in edible oil versus biodegradation, as well as tracking biodegradation rates.

### **3.6.1 Contaminants and Dechlorination Products**

The parent chlorinated solvents and intermediate degradation products are analyzed to determine changes in the concentration and distribution of CAHs in the aquifer over time. In addition, the ratio of the parent compounds and dechlorination products should change as biodegradation is stimulated. At a minimum, analysis of volatile organic compounds (VOCs) by USEPA Method SW8260B should be used. Analysis of the final dechlorination products of the dechlorination sequence (*e.g.*, ethene and ethane, chloride) is also recommended. In cases where biogeochemical reduction may be significant, analyses of optional degradation products (such as acetylene) may be warranted. The distribution of dechlorination products will be distinctly different between sequential reductive dechlorination by biological processes than would result from biogeochemical reduction ([Section 6](#)).

### **3.6.2 Biogeochemistry**

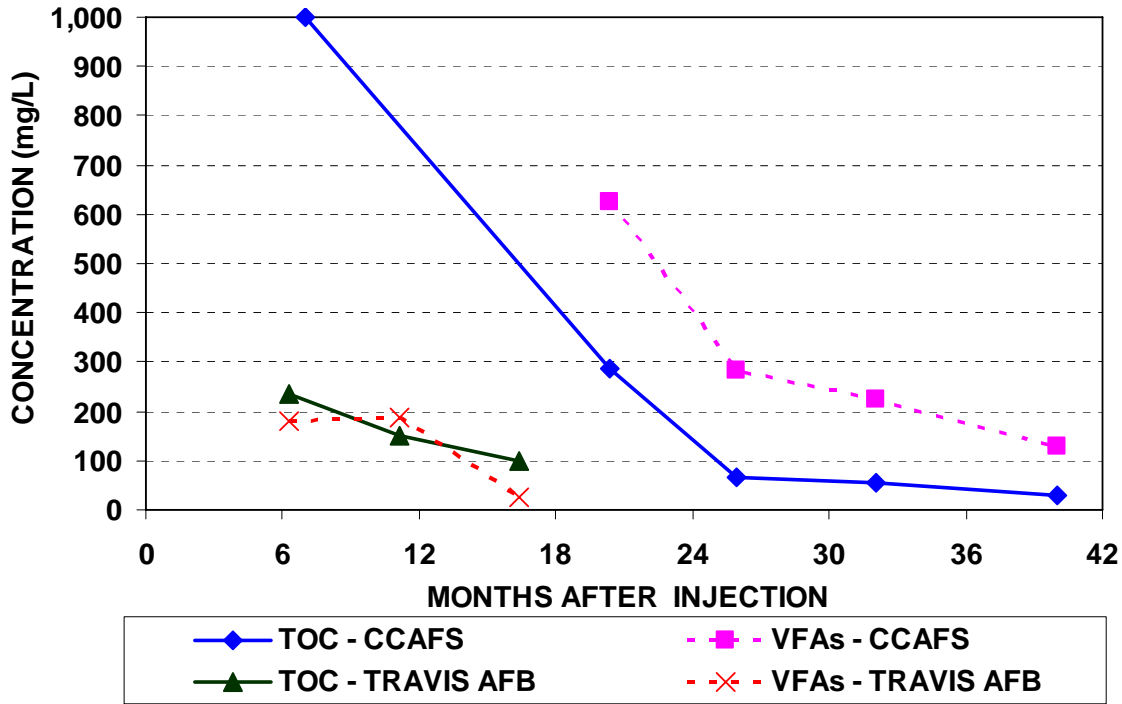
Biogeochemical parameters are measured to determine whether conditions are suitable for enhanced anaerobic reductive dechlorination of CAHs to occur. Profound changes in redox processes may occur as a result of substrate addition, and the predominant electron acceptor being utilized by microbial activity often varies in zones across the site. Addition of an edible oil is intended to deplete competing electron acceptors and to maintain anaerobic conditions that are optimal for high rates of reductive dechlorination to occur. Excessive levels of competing electron acceptors (*e.g.*, DO and sulfate) may limit the effectiveness of substrate addition. Therefore, groundwater geochemical conditions across the site should be measured in order to identify any undesirable geochemical conditions.

Common geochemical parameters used to evaluate enhanced bioremediation using edible oil are listed in [Appendix F](#). At a minimum, parameters that should be measured include DO, oxidation-reduction potential (ORP), nitrate, manganese, Fe(II), sulfate, methane, alkalinity, and pH.

### **3.6.3 Indicators of Organic Carbon**

Indicators of organic substrate (electron donor) available for biodegradation processes includes TOC (unfiltered samples) or DOC (filtered samples), and volatile fatty acids (VFAs, or metabolic acids). TOC is more commonly measured than DOC for edible oil systems because the oil substrate may be present in suspended or colloidal form. Total inorganic carbon (TIC) may be measured as an indicator of organic carbon that has been degraded to inorganic byproducts.

TOC and VFAs should be monitored over time to evaluate longevity of the edible oil. Levels of TOC and VFAs should be expected to decline over time as microbial growth and activity increases and the substrate is consumed. **Figure 3.2** is an example of TOC and VFAs levels over time for edible oil applications at Travis AFB, California, and CCAFS, Florida. The concentrations plotted are averages for monitoring wells with TOC concentrations greater than at least 10 mg/L, as an indicator that the locations were impacted by edible oil addition. Note that VFAs appear to compose most, if not all, of the soluble TOC present, although direct comparison of TOC and VFA concentrations may not be appropriate due to differences in the analytical methods used.



**Figure 3.2** Concentrations of TOC and Total VFAs Over Time for Two Sites (average of monitoring wells with TOC >10 mg/L)

### 3.6.4 Microbiological Characterization

In many cases, favorable contaminant and geochemical data may suffice for site selection purposes. However, sites exhibiting marginal or difficult biogeochemical conditions may benefit from the use of a variety of microbial screening methods. Additional information regarding the microbiology of enhanced reductive dechlorination is provided in **Appendix B** and in the Principles and Practices document (AFCEE *et al.*, 2004). The microbial screening methods most commonly used include laboratory analysis of site samples for the presence of *Dehalococcoides* species and laboratory microcosm studies. Compound-specific isotope analysis (CSIA) can also provide valuable insights into biodegradation activity at a site, particularly when results from traditional analyses may be confounded by issues such as dilution, partitioning into edible oil, or sorption/desorption from aquifer solids.

Molecular biological screening for *Dehalococcoides* organisms is a useful diagnostic tool to indicate whether complete dechlorination of chlorinated ethenes (PCE, TCE c-DCE and vinyl chloride) to ethene is likely to occur (Stroo *et al.*, 2006). MBTs are most likely to produce useful results after the growth of anaerobic microorganisms has been stimulated through substrate addition. *Dehalococcoides* organisms have also been implicated in the dihaloelimination of 1,2-DCA and 1,2-dichloropropane (Maymo-Gatell *et al.*, 1999; Ritalahti and Löffler, 2004), the debromination of vinyl bromide (He *et al.*, 2003), and the partial dehalogenation of certain chlorinated benzenes (Adrian *et al.*, 2000), polychlorinated biphenyls (Fagervold *et al.*, 2005; Bedard *et al.*, 2006; Yan *et al.*, 2006), polychlorinated dibenzodioxins (Bunge *et al.*, 2003; Fennell *et al.*, 2004), and polybrominated diphenyl ethers (He *et al.*, 2006).

Several MBTs are commercially available for *Dehalococcoides* organisms. An EPA method for assessing *Dehalococcoides* organisms is not currently available but efforts to standardize the techniques are being funded by SERDP ([www.serdp.org](http://www.serdp.org)). A recent publication by SERDP and ESTCP (2005) summarized the current state of research for MBT and provides a general overview of the various tools and their respective advantages and disadvantages.

The most widely used MBT technique involves screening for the *Dehalococcoides* 16S rRNA gene. Early field demonstrations of this semi-quantitative, genus-specific test are reported in Fennell *et al.* (2001), Hendrickson *et al.* (2002), and Major *et al.* (2002). Current versions of this test offer much more precise quantification (*e.g.*, Lendvay *et al.*, 2003; Lu *et al.*, 2006) which may assist with the estimation of dechlorination rates (Lu *et al.*, 2006). While these 16S rRNA gene-based tests are highly effective in most cases, there is potential for both false negatives and false positives. False negatives arise because *Dehalococcoides* organisms may not be detectable in all areas of a site (*e.g.*, Fennell *et al.*, 2001). Thus, field sampling techniques and the degree of aquifer heterogeneity should be carefully evaluated when making a determination that *Dehalococcoides* species are completely absent. False positives may arise because different *Dehalococcoides* populations have different substrate ranges, thus *Dehalococcoides* organisms may be detected at a site but cannot dehalogenate the contaminants of concern. Also, gene-based tests count both live and dead microorganisms, so concentrations measured may not accurately reflect the viable *Dehalococcoides* population.

Recently, new MBTs have been developed to address the false positive conditions described above. Quantitative screening for genes associated with vinyl chloride reduction to ethene (*vcrA* and *bvcA* genes) indicates whether the *Dehalococcoides* population detected has the potential for complete dechlorination of chlorinated ethenes (*e.g.*, Sung *et al.*, 2006). Also, MBTs that quantify expression of the 16S and/or dehalogenase genes are becoming available to detect only actively dechlorinating *Dehalococcoides* organisms. Microbial Insights ([www.microbe.com](http://www.microbe.com)) and SiREM Laboratories ([www.siremlab.com](http://www.siremlab.com)) are two leading providers of commercial MBT services for *Dehalococcoides* and other dechlorinating organisms such as *Dehalobacter*.

Other MBTs can be used to examine the total microbial community in the aquifer and/or test for multiple dechlorinating bacterial populations at once. These techniques are primarily based on 16S rRNA gene analysis and include terminal restriction fragment length polymorphism (T-RFLP), 16S rRNA gene cloning, and denaturing gradient gel electrophoresis (DGGE) (*e.g.*, Löffler *et al.*, 2000; Richardson *et al.*, 2002; Duhamel *et al.*, 2002). However, the detection of specific populations such as *Dehalococcoides* may be



subject to false negatives if the population of interest is not predominant in the overall community. In subsurface environments amended with electron donor, high concentrations of iron-reducing, sulfate-reducing, and fermentative populations may mask the detection of the relatively low concentrations of dechlorinating organisms. Thus, these techniques are most productively used on laboratory cultures with relatively low microbial diversity as opposed to field samples.

Microcosm studies can range from \$10,000 to \$40,000, and may take 4 to 12 months to complete. However, when other site selection indicators are marginal, microcosm studies coupled with *Dehalococcoides* identification can be a helpful bench-scale tool in predicting the extent to which anaerobic reductive dechlorination of CAHs will occur.

CSIA is an innovative technique which can indicate whether a compound has undergone a chemical or biological transformation rather than a physical process such as dilution or sorption. CSIA may also help to elucidate biodegradation pathways, which can provide valuable data at sites where multiple CAHs are degrading to vinyl chloride or other compounds of concern (*e.g.*, Hunkeler *et al.*, 2002). CSIA data can be used in conjunction with chemical concentration data or provide an additional line of evidence supporting results from MBTs and microcosm studies. North American providers of commercial CSIA services for aquifer samples include several leading universities as well as Microseeps ([www.microseeps.com](http://www.microseeps.com)).

### 3.6.5 Soil Characterization

Reactive iron sulfides have the potential to degrade many CAHs in groundwater (*e.g.*, Butler and Hayes, 1999; 2000; 2001; Adrians *et al.*, 2001; Gander *et al.*, 2002; Kriegman-King and Reinhard, 1994). At sites where sufficient bioavailable iron and sulfate are present, soil characterization of the changes in iron and sulfide minerals may be warranted to determine if biogeochemical reduction contributes to contaminant destruction. The data collected should support an evaluation of iron sulfide formation and potential contaminant degradation via biogeochemical reduction processes.

Total iron in soil should be measured if representative data do not currently exist. Field measurements of dissolved sulfate and hydrogen sulfide should be conducted in monitoring wells within and immediately downgradient of the reaction zone. The presence of high soil iron (>15,000 milligrams per kilogram [mg/kg]), high dissolved sulfate (>100 mg/L) upgradient, low dissolved sulfate (>20 mg/L) downgradient, and elevated dissolved hydrogen sulfide are considered to be positive indicators of iron sulfide formation and potential for biogeochemical reduction.

After these data are evaluated, one should determine whether more detailed iron sulfide(s) profiling is indicated. More detailed iron and sulfide analyses are listed in **Appendix F**, and iron and sulfide profiling techniques are provided in AFCEE (2000a), Allen *et al.* (2001); Kennedy *et al.* (1999), and Wilkins and Bischoff (2006). Microseeps ([www.microseeps.com](http://www.microseeps.com)) is a provider of commercial services for evaluating iron and sulfide species in soil samples. Care must be exercised that soil samples are collected and maintained in an anaerobic environment (Wilkin and Ford, 2006).

### 3.6.6 Soil Gas

Soil gas is collected for two reasons. First, soil gas may be collected and analyzed for chlorinated compounds to better characterize soil contamination and to identify potential source areas. Depending on the status of the site, this work may have been completed during previous remedial investigation work. Second, soil gas is used to monitor the accumulation in the vadose zone of chlorinated compounds or biogenic gases that may pose a health or safety risk (*e.g.*, VC or methane) or are a nuisance (*e.g.*, odor associated with hydrogen sulfide).

Monitoring for methane should be conducted when edible oil is applied near the water table surface and in close proximity to occupied buildings, due to potential for the formation of methane from biodegradation of the injected oil. Biodegradation of methane will occur rapidly in the presence of oxygen, and soil gas oxygen concentrations should be measured to determine if methane is likely to be degraded *in situ*. Soil gas carbon dioxide concentrations may also be measured because carbon dioxide is a precursor of methane and is indicative of anaerobic conditions.

Partial reductive dechlorination may also result in an increased vapor risk, for example the production of *cis*-1,2-DCE and VC. Therefore, VOCs may also have to be monitored when soil vapor is a potential exposure pathway.

### 3.6.7 Downgradient Water Quality

Secondary impacts of anaerobic bioremediation on downgradient water quality may also be required as part of the monitoring protocol (Section 2.2). Applicable regulations regarding secondary water quality should be reviewed to determine which parameters may be regulated at a test site.

## 3.7 PROCEEDING TO FULL-SCALE APPLICATION

Pilot tests may range from simple push-pull test to multiple well injections monitored over periods of 1 to 2 years. Pilot testing provides confirmation of that site conditions are suitable for the edible oil process, and provides information for design criteria such as well spacing, injection volumes, and flow rates. [Section 6](#) provides methods for interpreting pilot test results. Given a positive performance, full-scale implementation can proceed using the experience gained during pilot testing. Lessons learned in the pilot test can be used to revise the preliminary conceptual design to improve performance and reduce costs. The cost and performance of the full-scale approach can then be compared against other alternatives. Details on the design and implementation of full-scale approaches are described in [Section 4](#) and [Section 5](#), respectively.

## SECTION 4

### DESIGN OF FULL-SCALE EDIBLE OIL APPLICATIONS

This section presents procedures for the design of *in situ* anaerobic bioremediation applications using edible oil. Before proceeding with this section, users should complete an initial screening to evaluate whether the edible oil process is an appropriate technology for remediation of chlorinated solvents in groundwater at their site ([Section 2](#)). A preliminary conceptual design for a full-scale application at the site should be developed following the procedures described in this section. If application of the edible oil process appears to be a reasonable approach, then a pilot test ([Section 3](#)) may be implemented to test the procedures necessary to implement the conceptual design and to determine the extent to which anaerobic degradation of chlorinated solvents can be stimulated. The edible oil process is a flexible technology, and many of the alternatives described in this section can be used to design for site-specific conditions.

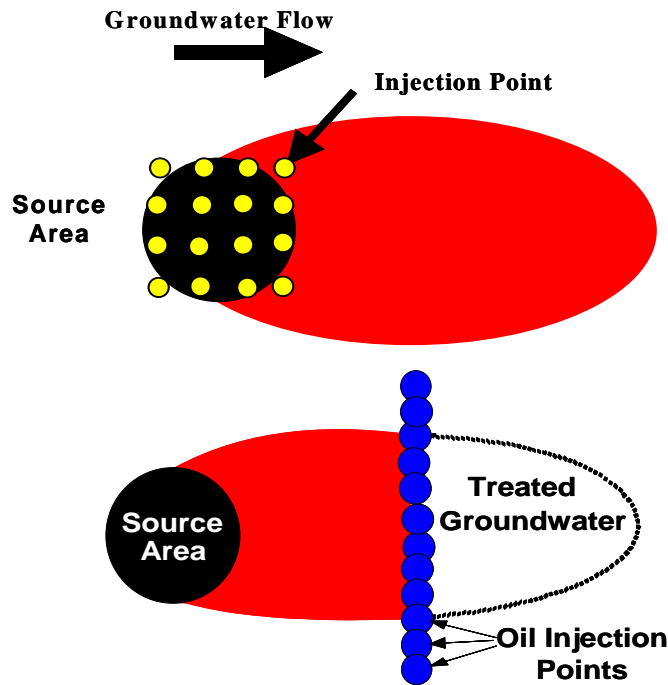
#### 4.1 REMEDIAL OBJECTIVES AND EDIBLE OIL CONFIGURATIONS

It is important to understand the remedial objectives of the project when choosing a treatment approach for a given site ([Section 1.4](#)). These objectives will determine which edible oil configuration and design are most appropriate.

##### 4.1.1 Remedial Objectives

Remedial objectives may be to reduce contaminant concentrations to below applicable regulatory standards (*e.g.*, drinking water MCLs), to reduce mass discharge from a source area as part of an overall risk reduction approach, to limit plume migration and expansion, or to accelerate the time frame for a MNA remedy. The ability to reduce concentrations of CAHs to below drinking water MCLs has been demonstrated in some settings, but may not be a practical objective for sites with complex DNAPL sources, large dissolved plumes, or complex mixtures of CAHs. This is often true for any remedial technology; enhanced *in situ* anaerobic bioremediation is often chosen as the most cost effective approach for managing the risk associated with CAHs in groundwater.

Treatment approaches considered for application of edible oil are generally segregated into source area treatment or a permeable biobarrier to intercept a CAH plume ([Figure 4.1](#)). Remedial objectives for source areas are often focused on reduction of mass discharge from the source area to the larger dissolved plume, with longer term destruction of contaminant mass. Remedial objectives for a permeable biobarrier are usually to reduce aqueous concentrations to below applicable regulatory criteria either within the biobarrier or at a downgradient point of compliance. The design of an edible oil application for a source area versus a biobarrier may vary considerably.



**Figure 4.1 Injection Configurations for Using Edible Oil to Treat Contaminated Groundwater in: (a) Source Areas and (b) Biobarriers**

#### 4.1.2 Treatment System Configurations

Treatment configurations for contaminated aquifers using edible oil include source area treatments and biobarriers along the axis of the contaminant plume (Figure 4.1). The following sections describe the factors that should be considered when determining the configuration of the treatment zone.

##### 4.1.2.1 Source Areas

Source areas may include chlorinated solvents in the dissolved, sorbed, and DNAPL phases. Remedial objectives for source areas include a reduction in mass discharge, and mass destruction may be a longer term objective. For this reason, source area treatment may include sequestration of dissolved CAHs into the oil phase as part of the design. A reduction in hydraulic conductivity may be acceptable or even desirable to limit groundwater flow through or out of the source zone. Addition of edible oil can rapidly reduce contaminant concentrations in the aqueous phase by partitioning of a portion of the CAH mass into the edible oil (*i.e.*, sequestration). Biodegradation of the oil will then stimulate anaerobic conditions and biodegradation of CAHs in the aqueous phase. As contaminants are released by desorption from the oil or from the aquifer matrix, or by dissolution from residual DNAPL, edible oil will still be present to sustain anaerobic biodegradation processes.

Source areas can be treated using pure edible oil or an edible oil emulsion. The residual saturations for pure edible oil are generally higher than for emulsions. Consequently, pure oil is most useful when the objective is to sequester chlorinated solvents in the oil phase and to

block the aquifer pore spaces, reducing groundwater flow within the treatment zone and mass discharge from the source area. Edible oil emulsions are generally applied at lower residual saturations, typically with the oil content at less than 10 percent of the pore volume for a source area application. Consequently, emulsions may be less effective for sequestering chlorinated solvents and reducing groundwater flow than pure oil. However, if the objective is primarily to stimulate biodegradation for mass removal in the source area, emulsions are beneficial because they are easier to distribute over a greater volume of the aquifer and with a more uniform distribution than pure oil.

An example of treating a CAH source area using pure edible oil at CCAFS, Florida is included in [Appendix H](#). Other examples of source area treatment using pure edible oil or edible oil emulsions include Lee *et al.* (2005), Ferris *et al.*, 2006, Newman and Pelle (2006), and Jacob *et al.* (2007).

#### **4.1.2.2 Permeable Biobarriers for Plume Treatment**

A biobarrier may be used to intercept a CAH plume upgradient of a property boundary, potential receptor, or other point of compliance. Biobarriers are typically installed across the plume, perpendicular to groundwater flow. As with any permeable barrier configuration, the amendment used to create the reaction zone must be uniformly distributed, and the permeability of the reaction zone maintained to prevent contaminant bypass. As a consequence, edible oil emulsions are more suitable for use than pure oil in permeable biobarrier configurations. Many of the design considerations for an edible oil biobarrier are similar in nature to those for designing permeable mulch biowalls or for permeable reactive barriers using zero-valent iron. A summary of the design and implementation of zero-valent permeable reactive barriers can be found in a joint document between the Remediation Technology Development Forum (RTDF) and the USEPA Office of Research and Development (USEPA and RTDF, 1998).

The width of the biobarrier should be wider than the width of the contaminant plume that requires remediation to allow for uncertainty in the actual plume dimensions, variations in groundwater flow direction, and for some permeability loss. At sites with sufficient natural attenuation capacity of the aquifer, it may be reasonable to install biobarriers to target only that portion of the plume that cannot be naturally assimilated prior to potential exposure to a downgradient receptor, and allow the lower concentration portions of the plume to naturally attenuate (to lower implementation costs).

When using edible oil emulsions, the permeability loss associated with the injected emulsion is expected to be minor. However, biomass growth and gas production may result in up to an order-of-magnitude reduction in permeability (Long and Borden, 2004). Common groundwater flow and transport models (*e.g.*, MODFLOW and MT3D) can be used to assess the impacts of permeability loss on barrier performance and determine the required biobarrier width to prevent contamination from bypassing the biobarrier. In most cases, up to a factor of 10 reduction in permeability in a 20- to 40-foot thick biobarrier should not be a significant issue if the size of the biobarrier reaction zone extends beyond the extent of contamination. Therefore, the barrier width should be increased, perhaps by 10 to 20 percent, to prevent a portion of the plume targeted for treatment from bypassing around the edges of the biobarrier. This will be site-specific based on what level of contamination is acceptable to let pass by the biobarrier (if any).

Residence time within the biobarrier reaction zone will be controlled by the velocity of groundwater flow and barrier thickness along the direction of groundwater flow. Determining the residence time required for effective treatment depends on the contaminant concentrations present and the degradation rates that can be achieved. This will be highly site-specific, and at present there is no reliable, all-inclusive method for determining the required residence time. A residence time of 1 to 3 months may be suitable for many CAH plumes. For example, assuming a groundwater flow velocity of 100 ft/yr, a 1 to 3 month contact time results in required barrier thickness of at least 8 to 24 feet along the direction of groundwater flow. A 1 to 3 month residence time estimate may be used for preliminary planning purposes. However, field pilot studies are typically needed to determine the required residence time/barrier thickness for a specific site. The presence of preferential flow paths with higher rates of groundwater flow should be taken into consideration when estimating residence time.

Many design considerations are common to both source area and biobarrier configurations (*e.g.*, determining the amount of oil for effective treatment), but the manner in which they are applied may differ. For example, maintaining aquifer permeability is a priority for biobarrier configurations, but may not be necessary for source area treatment. The following sections describe key design considerations, including general design considerations common to both configurations, and those that are specific to either source areas or biobarriers.

## 4.2 GENERAL DESIGN PARAMETERS

The primary factors to consider when designing an edible oil application for either a source area or a biobarrier configuration include the following:

- Contaminant concentrations;
- Treatment zone dimensions;
- Amount of oil required for effective treatment;
- Inclusion of other reagents or amendments to address site-specific conditions;
- Source of make-up or chase water;
- Dilution of the oil in water (when using emulsions) or amount of chase water required;
- Injection well spacing (radius of influence) and vertical injection intervals; and
- Injection well design.

The following subsections describe these design considerations as they apply to design of edible oil applications in general. Design considerations specific to either source areas or to biobarriers are described further in [Section 4.3](#) and [Section 4.4](#), respectively.

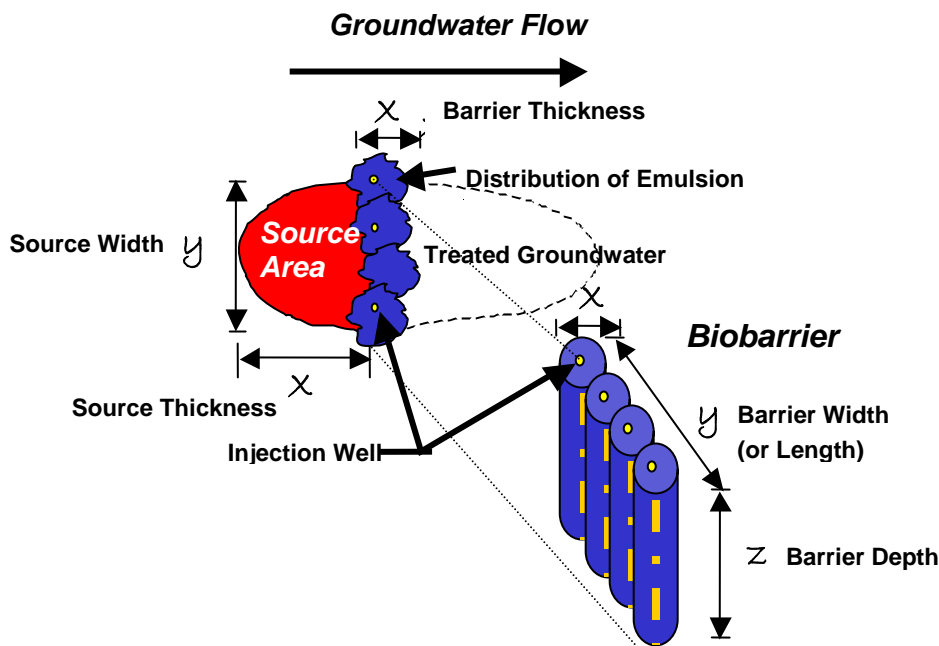
### 4.2.1 Treatment Zone Dimensions

[Figure 4.2](#) shows the dimensions that are considered in planning a source zone or permeable biobarrier design. A typical source area treatment can be designed by first determining 1) the width of the source perpendicular to groundwater flow ( $y$ ), 2) the

thickness of the area targeted for treatment parallel to groundwater flow ( $x$ ), and 3) the effective vertical height ( $z$ ) of the treatment zone. The mass flux of competing electron acceptors and contaminants (if any) into the treatment area can be calculated using by multiplying the upgradient concentrations by the groundwater flux through the treatment zone over time. Groundwater flux, or discharge across the upgradient plane of the source area treatment zone, can be calculated using Darcy's Law:

$$Q = KA(dh/dl) \quad (4-1)$$

Where:  $Q$  = groundwater discharge (*e.g.*, cubic meters per day [ $m^3/day$ ])  
 $K$  = hydraulic conductivity (*e.g.*, meters per day [ $m/day$ ])  
 $A$  = cross-sectional area (*e.g.*, square meters [ $m^2$ ])  
 $dh/dl$  = hydraulic gradient (unit less)



**Figure 4.2 Dimensions Used in Calculating a Treatment Zone**

For a permeable biobarrier design, the length or width of the biobarrier perpendicular to groundwater flow ( $y$ ) and depth ( $z$ ) of the biobarrier to intercept the contaminated zone must first be determined based on the dimensions of the portion of the plume targeted for treatment (Figure 4.2). The thickness ( $x$ ) of the biobarrier along the direction of groundwater flow should provide sufficient contact time between the contaminant and the oil treated aquifer matrix to allow for complete degradation of the contaminants to non-toxic byproducts.

For sites at which degradation rates are unknown, a 1- to 3-month residence time may provide a conservative estimate of residence time required for complete treatment. Shorter residence times may be acceptable if high treatment efficiencies are not required or pilot test data confirms that site-specific contaminant degradation rates support a lesser residence time. Site-specific pilot tests have the potential to reduce full-scale costs when reaction rates are proven higher than conservative design estimates. Longer residence times may be needed if contaminant or electron acceptor (*e.g.*, sulfate) concentrations are high. The cross-sectional area of the biobarrier is then used to determine groundwater flux through the biobarrier using

Darcy's Law (Equation 4-1). The groundwater flux is then multiplied by upgradient contaminant and competing electron acceptor concentrations to calculate the mass flux of contaminants and competing electron acceptors through the biobarrier ([Appendix G](#)).

#### 4.2.2 Amount of Oil Required for Effective Treatment

There are three main issues to consider in determining how much oil to amend to the subsurface:

- Consumption of oil during biodegradation of the contaminants, biodegradation of native electron acceptors (*e.g.*, oxygen, nitrate, sulfate), production of methane, and downgradient release of DOC;
- Retention (sorption or entrapment) of pure edible oil or emulsified edible oil within the aquifer matrix; and
- Partitioning of CAHs into the edible oil (for source area sequestration).

The total amount of oil required for effective treatment is also a function of the size of the treatment zone, the volume of water to be treated, the electron acceptor demand (or hydrogen demand) exerted by both native electron acceptors and the CAHs present, and the design life of the application.

[Appendix G](#) provides an example spreadsheet illustrating the calculations that may be used to determine the amount of oil or emulsified oil product required based on site-specific input. Additional description of determining substrate demand based on stoichiometric relationships can be found in Appendix C of the Principles and Practices document. The following subsections describe the parameters and calculations used to determine the amount of edible oil substrate for a site-specific application.

##### 4.2.2.1 Site Hydrogeology and Volume of Water to be Treated

For a source area treatment, the volume of water to be treated is the volume within the treatment zone and the groundwater discharge ( $Q$ ) into the treatment zone during the treatment period. The volume of water within the treatment zone is simply obtained by multiplying the length along the direction of groundwater flow ( $x$ ), width perpendicular to flow ( $y$ ), vertical height of the treated zone ( $z$ ), and effective porosity ( $n_e$ ) of the treatment area ([Figure 4.2](#) and [Appendix G](#)).

The groundwater discharge ( $Q$ ) into the treatment zone is determined using the dimensions described above to calculate the groundwater flux through the upgradient cross-sectional area of the treatment cell based on Darcy's Law (Equation 4.1). The groundwater flux (gallons/year or liters/year) is then multiplied by the design life (years) and this value is added to the volume within the treatment cell to obtain the total treatment volume (gallons or liters).

For a biobarrier design, the volume of water to be treated is calculated in a similar manner. Biobarriers are typically placed across a plume perpendicular to the direction of groundwater flow with a width ( $y$ ) that is somewhat greater than the contaminant plume to minimize the potential for contaminated groundwater to flow around the barrier without passing through the treatment zone. The thickness ( $x$ ) of the biobarrier along the direction of groundwater flow



should provide sufficient contact time between the contaminant and the oil treated aquifer matrix to completely degrade the contaminant to non-toxic byproducts.

When determining the effective vertical height ( $z$ ) of a biobarrier, designers should consult boring logs from the site to estimate the vertical thickness of the aquifer that transmits most of the contaminated groundwater. For example, at a typical site, the chlorinated solvent plume may extend from 20 to 40 feet below grade. However, this contaminated interval may consist of sand and clay layers. In such a case, essentially all of the groundwater flow will be through the sand layers, so these layers are targeted for treatment. While it might be desirable to treat the entire vertical extent of contamination, experience has shown that edible emulsions tend to be preferentially distributed in the higher permeability layers.

Given that injected substrates will flow along paths of higher permeability, it may be advisable to further characterize the site with respect to vertical contaminant and hydraulic profiles. Vertical intervals where contaminant concentrations and/or hydraulic conductivity estimates are an order of magnitude different than the surrounding formation should be targeted using discrete well screened intervals. Elevated contaminant concentrations in more permeable intervals may be more compatible with longer injection well screen intervals. However, discrete well screen intervals should also be considered when contaminant concentrations are elevated and localized in lower permeability layers.

For the example calculations in [Appendix G](#), the width of the proposed biobarrier can be entered into the barrier design spreadsheet in *Section A* along with the minimum and maximum depths of the contaminated zone. These inputs are used to calculate the cross-sectional area of the biobarrier. Site-specific hydrogeologic properties (effective porosity, hydraulic conductivity, and hydraulic gradient) are then entered in *Section B* and are used to calculate the groundwater seepage velocity and groundwater discharge ( $Q$ ) through the biobarrier by applying Darcy's Law. The treatment volume is then calculated using the design life (*e.g.*, 5 years) entered in *Section C*.

#### **4.2.2.2 System Design Life**

Estimating the required design life for a source area treatment is difficult due to the complex distribution of chlorinated solvents in the subsurface that results from a release of a DNAPL. Laboratory studies and field pilot tests have demonstrated that edible oil addition can stimulate rapid biodegradation of contaminants in more permeable zones with contaminants degraded to low levels in 12 to 24 months.

However, mass transfer limitations may greatly reduce the rate that DNAPL and CAHs diffused or adsorbed in low permeability zones are degraded. If residual edible oil is present, aqueous phase contaminants will be degraded as they diffuse out into the more permeable portions of the aquifer. Once the edible oil is depleted, aqueous phase contaminants may be released to the downgradient aquifer. Therefore, the design life for a source area treatment should be conservative to account for mass transfer limitations. A single application of pure edible oil at the Hangar K Site at CCAFS, Florida was effective over a period of 4 to 5 years with little rebound in CAH concentrations ([Appendix H.1](#)). More complex DNAPL source areas may require a longer treatment period.

A biobarrier should be designed to provide sufficient substrate for a given time period that takes into consideration the mass flux of CAHs and native electron acceptors, and accounts

for losses from the biobarrier due to methane production and release of DOC. Additional injections may be required for longer treatment durations (*e.g.*, several years) or at sites with a high flux of native electron acceptors through the biobarrier.

Although tested at multiple sites, the installation of permeable biobarriers composed of edible oil emulsions is relatively new. Consequently, there is limited information about the actual longevity of the emulsified oil in the aquifer. Zawtocki *et al.* (2004) and Zawtocki (2005) reported elevated TOC concentrations in a biobarrier beyond 2 years after injection of an oil-in-water soybean emulsion with no loss of biodegradation capability. Injection of vegetable oil at the Hangar K site at CCAFS sustained anaerobic conditions for a period of approximately 68 months (**Appendix H**). Oil longevity may be less, perhaps on the order of months to a year, at sites with high rates of groundwater flow, high levels of native electron acceptors, or high rates of contaminant mass flux through the biobarrier.

When selecting a design life, users should be aware that the calculations included in **Appendix G** assume the source area or biobarrier treatment will operate at 100% efficiency until the day when the organic substrate runs out. On that day, the treatment efficiency is assumed to drop to zero. However, in practice, treatment efficiency will begin to decline as substrate is depleted from the more permeable/contaminated zones, although remaining biomass may sustain bioactivity beyond depletion of the oil due to endogenous decay.

Consequently, users should include an appropriate factor of safety when selecting the design life. In addition, users should take into account project cost, contaminant source(s) and concentrations, and long term remedial objectives when selecting a design life. For long term biobarrier applications, a longer design life may be used with the assumption that additional edible oil will need to be injected after oil from the initial injection is depleted.

#### 4.2.2.3 Hydrogen Demand

As described in **Appendix D**, edible oil ferments in the subsurface generating hydrogen and acetate. The hydrogen and acetate are then used to support anaerobic reductive dechlorination of CAHs. However, hydrogen and acetate may also be consumed during biodegradation of naturally occurring electron acceptors including oxygen, nitrate, sulfate, ferric iron, and manganese. Methanogenesis may also consume a large proportion of hydrogen and acetate. As a consequence, designers must consider both the amount of contaminant to be degraded and the background electron acceptor load.

The amount of substrate required to reduce the mass of CAHs and/or native electron acceptors can be determined by calculating the stoichiometric hydrogen demand of the dissolved CAHs and electron acceptors (*e.g.*, see Appendix C of the Principles and Practices document). First, the contaminant and electron acceptor mass to be degraded is calculated by multiplying the average concentrations by the total groundwater treatment volume. The stoichiometric hydrogen demand required to reduce the contaminant mass can then be calculated by determining the amount of H<sub>2</sub> required for complete reduction of each contaminant or background electron acceptor. The stoichiometric demand is the mass ratio of the contaminant to hydrogen (weight contaminant/weight H<sub>2</sub> [wt/wt H<sub>2</sub>]) and is based upon balanced chemical reduction equations. For example, TCE is completely reduced to ethene according to the following equation:



Since it takes 3 moles of hydrogen (molecular weight = 2.0158) to reduce 1 mole of TCE (molecular weight = 131.389) to ethene, the stoichiometric hydrogen demand is 131.389 divided by 6.047 (3 x 2.0158) or 21.73 (wt/wt H<sub>2</sub>). Therefore, 21.73 grams of TCE is degraded per gram of hydrogen. Similar calculations can be done for each CAH and electron acceptor to determine the stoichiometric hydrogen demand. For each CAH or electron acceptor, the mass is divided by the stoichiometric hydrogen demand to determine the mass of hydrogen required to reduce the contaminant mass. **Table 4.1** provides the chemical reduction equations and stoichiometric hydrogen demand for typical chlorinated solvents and electron acceptors.

**Table 4.1**  
**Stoichiometric Hydrogen Demand for Different Contaminants and Electron Acceptors**

<b>Chlorinated Solvents and Electron Acceptors</b>	<b>Chemical Reduction Equation</b>	<b>Stoichiometric Hydrogen Demand (wt/wt H<sub>2</sub>)</b>
PCE	$C_2Cl_4 + 4H_2 \rightarrow C_2H_4 + 4H^+ + 4Cl^-$	20.57
TCE	$C_2HCl_3 + 3H_2 \rightarrow C_2H_4 + 3H^+ + 3Cl^-$	21.73
<i>cis</i> -1,2-DCE	$C_2H_2Cl_2 + 2H_2 \rightarrow C_2H_4 + 2H^+ + 2Cl^-$	24.05
Vinyl Chloride	$C_2H_3Cl + H_2 \rightarrow C_2H_4 + H^+ + Cl^-$	31.00
Carbon Tetrachloride	$CCl_4 + 4H_2 \rightarrow CH_4 + 4H^+ + 4Cl^-$	19.08
Chloroform	$CHCl_3 + 3H_2 \rightarrow CH_4 + 3H^+ + 3Cl^-$	19.74
1,1,1-TCA	$C_2H_3Cl_3 + 3H_2 \rightarrow C_2H_6 + 3H^+ + 3Cl^-$	22.06
1,1-DCA	$C_2H_4Cl_2 + 2H_2 \rightarrow C_2H_6 + 2H^+ + 2Cl^-$	24.55
Chloroethane	$C_2H_5Cl + H_2 \rightarrow C_2H_6 + H^+ + Cl^-$	32.18
Oxygen	$O_2 + 2H_2 \rightarrow 2H_2O$	7.94
Nitrate	$2NO_3^- + 2H^+ + 5H_2 \rightarrow N_2 + 6H_2O$	12.30
Sulfate	$2SO_4^{-2} + 3H^+ + 8H_2 \rightarrow H_2S + HS^- + 8H_2O$	11.91
Ferric Iron	$2Fe^{+3} + H_2 \rightarrow 2Fe^{+2} + 2H^+$	55.41
Manganese	$MnO_2 + 2H^+ + H_2 \rightarrow Mn^{+2} + 2H_2O$	27.25

The hydrogen released from different edible oils is shown in **Appendix D, Table D.10** and varies from 0.179 to 0.181 moles of H<sub>2</sub> per gram of oil (0.36 to 0.365 grams H<sub>2</sub>/gram oil) depending on the oil composition. The substrate demand is determined by dividing the calculated hydrogen demand for degradation of contaminants and electron acceptors by the amount of hydrogen produced from oil. *Section D* of the biobarrier design spreadsheet in **Appendix G** calculates the hydrogen demand of each contaminant and electron acceptor based on the entered concentrations.

#### 4.2.2.4 Additional Hydrogen Demands and Organic Carbon Released Downgradient

In addition to the contaminants and electron acceptors entering the treatment zone, hydrogen can be consumed during reduction of iron and manganese oxides present in the aquifer matrix. The best approach for estimating the iron and manganese demand is to directly measure the amount of iron and manganese oxides in the aquifer material. Unfortunately, these data are not commonly collected. An alternative approach is to estimate the iron and manganese demand based on the amount of dissolved iron and manganese released to the downgradient aquifer. In previous field studies, dissolved iron concentrations released from edible oil barriers typical vary between 5 and 50 mg/L with somewhat lower levels of dissolved manganese. This approach may underestimate the hydrogen demand exerted by iron and manganese, but should be a reasonable approximation in most cases.

Hydrogen and acetate not consumed by reductive dechlorination or electron acceptor reduction will be fermented to methane or released to the downgradient aquifer. As a consequence, additional substrate must be injected to account for any methane production and DOC released. In previous edible oil applications (*e.g.*, see [Appendix H](#)), methane concentrations downgradient from the treatment zone have varied between 5 and 20 mg/L. Immediately after oil injection, DOC concentrations released from edible oil biobarriers may exceed 200 mg/L. However, DOC concentrations typically decline with time reaching quasi-steady-state levels of 20 to 100 mg/L. Consequently, 50 to 100 mg/L DOC appears to be a reasonable range for the long-term average concentration released. Note that concentrations of DOC within this range may sustain anaerobic degradation processes and effectively extend the treatment zone in a downgradient direction.

The biobarrier and source treatment design spreadsheets ([Appendix G](#)) estimate the amount of substrate used for methane production and the amount of carbon lost from the biobarrier over time. These values are estimated by entering methane concentrations and DOC concentrations in *Section E* of the spreadsheet. The total amount of oil required to support contaminant biodegradation is then calculated in *Section F* of the spreadsheet. This value is only the amount of oil required. Other materials including easily biodegradable soluble substrates (*e.g.*, sodium lactate), bacterial nutrients and vitamins, and surfactants may be added to aid in emulsion preparation and to stimulate rapid growth of desired microbial populations. However, these materials are rapidly depleted and are not expected to support long-term reductive dechlorination.

#### 4.2.2.5 Oil Retention within the Aquifer Matrix

For effective treatment, pure edible oil or edible oil emulsions must be distributed throughout the target treatment zone. As oil is injected or as it migrates through the aquifer pore space, a significant amount is retained. For pure edible oil, the oil is trapped in the aquifer pores as large globules, typically retaining 1.0 to 20 pounds of oil per cubic foot (lb/ft<sup>3</sup>) of treated material (Coulibaly and Borden, 2004). For edible oil emulsions, the small oil droplets adhere to the sediment surfaces, typically retaining between 0.1 to 1.0 pounds of oil per cubic foot of treated material. (Coulibaly and Borden, 2004; Solutions IES, 2005). [Table 4.2](#) illustrates the range of emulsion retained in a variety of sediments in units of grams per gram (g/g). Site-Specific oil retention may need to be verified on an experimental basis (*e.g.*, column studies) if reasonable estimates cannot be found in the literature.

**Table 4.2**  
**Observed Emulsion Retention by Sediment**

Site Specific Aquifer Material	Maximum Retention (g/g)	Effective Retention (g/g)
Blended sand (7% silt + clay) (Coulibaly and Borden, 2004)	0.0054 (Lab Column)	0.0066 (Sandbox)
Blended sand (9% silt + clay) (Coulibaly and Borden, 2004)	0.0061 (Lab Column)	0.0035 (Sandbox)
Blended sand (12% silt + clay) (Coulibaly and Borden, 2004)	0.0095 (Lab Column)	0.0037 (Sandbox)
Aluvium (clayey sand) (Maryland Perchlorate Site)	0.0037 (Lab Column)	0.0013 (Field)
Low K, weathered rock (sandy clay with remnant fractures) (Burlington, NC)	Not measured	0.0017
High K, gravelly sand (Indiana)	Not measured	0.002

The amount of oil required to treat an aquifer based on oil retention alone is determined by multiplying the thickness along the direction of groundwater flow ( $x$ ), width perpendicular to flow ( $y$ ), vertical height of the treated zone ( $z$ ), and oil retention by the aquifer material in  $\text{lb}/\text{ft}^3$ . In many aquifers, the amount of oil retained while achieving a uniform distribution of oil throughout the aquifer matrix is much greater than the amount of oil required for biodegradation alone, and will control the total amount of oil that should be injected.

#### 4.2.2.6 Chlorinated Solvent Partitioning into Oil

As described in [Section D.2](#) of Appendix D, a retardation factor can be used to express contaminant transport velocity. As shown below, it also can be used to estimate the effect of oil injection on the concentration of chlorinated solvents in the aqueous phase as follows:

$$R \text{ (unit less)} = \text{total mass of contaminant} / \text{mass of contaminant in aqueous phase}$$

If all the contaminant is initially dissolved, oil injection should reduce the aqueous phase concentration by a factor equal to  $R$ . However, if a significant fraction of the chlorinated solvent is already sorbed to the aquifer sediment or is present as a DNAPL, the reduction in aqueous phase concentration will not be as dramatic.  $R$  can be calculated by the equation:

$$R = 1 + \rho_B f_o K_p / n \quad (4-2)$$

where:  $\rho_B$  is the aquifer bulk density ( $\text{g}/\text{cm}^3$ )  
 $f_o$  is the fraction of oil in the sediment ( $\text{g}/\text{g}$ )  
 $K_p$  is the oil-water partition coefficient (milliliters per gram [ $\text{ml}/\text{g}$ ])  
 $n$  is porosity (milliliters per cubic centimeter [ $\text{ml}/\text{cm}^3$ ])

$K_p$  values measured by Pfeiffer (2003) for PCE, TCE, *cis*-1,2-DCE and VC are presented in [Table 4.3](#). For other compounds, the octanol-water partition coefficient ( $K_{ow}$ ) can be used as a reasonable estimate of  $K_p$ .  $f_o$  is the grams of oil injected per gram of aquifer material and can be calculated as follows:

$$f_o = \frac{\text{pounds oil injected} / \text{ft}^3 \text{ aquifer}}{\text{aquifer bulk density (lb/ft}^3\text{)}} \quad (4-3)$$

**Table 4.3**  
**Oil-Water Partition Coefficients ( $K_p$ ) for Pure PCE, TCE, *cis*-1,2-DCE, VC and Mixtures of these Materials between Water and Soybean Oil (Pfeiffer, 2003)**

Chlorinated Ethene	Solubility in water (mg/L)	$K_p$ (ml/g)	$K_{ow}$ (ml/g)
PCE	145 @ 24 °C	1,240 (pure compound @ 20 °C) 531 (mixture @ 20 °C) 188 (mixture @ 10 °C)	2,500
TCE	1,100 @ 18 °C	338 (pure compound @ 20 °C) 373 (mixture @ 20 °C) 171 (mixture @ 10 °C)	263
<i>cis</i> -1,2-DCE	2,100 @ 18 °C	61 (pure compound @ 20 °C) 53 (mixture @ 20 °C) 52 (mixture @ 10 °C)	72
VC	2,500 @ 18 °C	22 (pure compound @ 20 °C) 22 (mixture @ 20 °C) 26 (mixture @ 10 °C)	23

Estimated retardation factors for PCE, TCE, *cis*-1,2-DCE and VC in aquifers treated with pure edible oil and edible oil emulsions are presented in **Table 4.4**. For illustration purposes, the sediment oil content for pure oil was calculated assuming 50 percent of the aquifer pore space is occupied by oil (typical residual saturations may be closer to 20 or 30 percent). For emulsion treated aquifers, the sediment oil content was calculated assuming 2 percent residual saturation, a typical value reported by Coulibaly and Borden (2004).

Injection of emulsified edible oil into source zones is not expected to dramatically reduce the amount of CAHs released from these areas. While sorption of PCE will be appreciable, the edible oil often stimulates rapid conversion of PCE to *cis*-1,2-DCE, VC and/or ethene. The much lower partition coefficients for the less chlorinated compounds will substantially reduce the impact of CAH sorption in emulsified oil. In source areas treated with pure edible oil, the impact of CAH sorption to the entrapped oil is expected to be much more significant due to the much larger amounts of oil injected.

**Table 4.4**  
**Estimated Retardation Factors for Different Chlorinated Ethenes**

Comment	Pure Oil	Emulsions
Sediment Bulk Density, $\rho_B$ (g/cm <sup>3</sup> )	1.86	1.86
Porosity (n)	0.3	0.3
Oil fraction (g/g)	0.074	0.003
PCE Retardation Factor ( $K_p = 1240$ )	570	24
TCE Retardation Factor ( $K_p = 338$ )	156	7
<i>cis</i> -1,2-DCE Retardation Factor ( $K_p = 61$ )	29	2.1
VC Retardation Factor ( $K_p = 26$ )	12	1.5

#### 4.2.2.7 Summary – How Much Oil Do You Need?

Two primary approaches are used to determine how much edible oil substrate is required for a given application. The first approach is to calculate a hydrogen demand based on stoichiometric relationships between electron acceptors (CAHs and native) and electron donor (hydrogen). The second approach is based on how much oil is necessary to obtain a uniform distribution of oil throughout the treatment zone based on how much oil will be retained within the aquifer matrix.

*Estimates of the amount of oil to add are based on either 1) the stoichiometric hydrogen demand, or 2) the retention of oil in the aquifer matrix. In many cases, the determining factor will be the oil retention. Better tools are still needed to improve our estimates of the edible oil requirements.*

For the first approach, the amount of oil required to support contaminant biodegradation will be a function of: (a) treatment zone dimensions; (b) site hydrogeology; (c) the system design life; (d) the amount of electron acceptors entering the treatment zone (both CAHs and native electron acceptors); (e) utilization of substrate for methanogenesis, and (f) release of DOC to the downgradient aquifer. Various calculations and potential safety factors are used to estimate the amount of substrate required using site-specific data and design criteria. For ease of understanding and calculation, the factors that are considered to calculate substrate requirements based on hydrogen demand are presented in a spreadsheet in [Appendix G](#).

Another consideration in how much oil to apply should also be related to the mass of oil needed to obtain a uniform distribution of substrate throughout the treatment zone. To determine the amount of oil required for the second approach, estimate 1) oil requirement for biodegradation (*i.e.*, to meet the hydrogen demand), and 2) the amount that will be retained within the aquifer matrix. Some examples of oil retention for sand and sediments on a weight/weight basis are listed in [Table 4.2](#). The appropriate amount of oil to apply will be the largest of these two values. When using pure edible oil, oil entrapment within the aquifer pore spaces is usually the controlling factor. When designing biobarriers using emulsions, oil retention by sediment is the controlling factor in lower groundwater velocity environments while substrate demand for biodegradation may be the controlling factor in very high groundwater flow environments with large amounts of competing electron acceptors (*e.g.*, sulfate). It should be noted that amendment of large quantities of oil may result in excessive production of volatile fatty acids, which could result in suppression of the groundwater pH and may require buffering of the groundwater to maintain bioactivity.

#### 4.2.3 Amendments

Other bioremediation reagents or amendments may be used for 1) rapid stimulation of anaerobic conditions (*e.g.*, soluble organic substrates), 2) verification of substrate distribution (*e.g.*, tracers), 3) enhancement of subsurface microbiology (*e.g.*, nutrients like phosphates or yeast extract, or bioaugmentation cultures), 4) modification of aquifer geochemistry (*e.g.*, pH/buffering adjustment), and/or 5) enhancements for biogeochemical reduction. [Table 4.5](#) lists a few options for amendments that may be considered in an emulsion mixture or for a water chase.

**Table 4.5**  
**Alternative Amendments for Edible Oil Emulsions or Water Chase**

<b>Amendment</b>	<b>Examples</b>	<b>Use</b>	<b>Typical Concentration Range in Injected Fluid (mg/L)</b>
Soluble Substrate	Sodium Lactate Fructose	Rapidly deplete native electron acceptors and establish highly reducing conditions	100 to 10,000
Tracer	Sodium Bromide	Conservative tracer to track substrate distribution (immediately after injection) and to determine seepage velocity (over time)	50 to 500
Nutrients	Yeast Extract Di-ammonium Phosphate	Nutrients for microbial growth	100 to 1,000
Microbiology - Bioaugmentation	Bioaugmentation cultures, for example <i>Dehalococcoides</i> species	Accelerate or encourage complete dechlorination to ethene.	10 <sup>7</sup> to 10 <sup>10</sup> (cells per liter)
Buffering Compounds	Sodium Bicarbonate Potassium carbonates	Maintain pH by buffering acids produced by biological activity	1,000 to 10,000
Biogeochemical Reduction (experimental)	Sulfate – Calcium Sulfate (gypsum) or Magnesium Sulfate (Epsom salts)	Source of sulfate for biological production of hydrogen sulfide, which reduces ferric iron in the aquifer matrix to precipitate reactive iron monosulfides.	1,000 to 10,000

Soluble substrates have been added to emulsion mixtures at several Air Force sites, including at Tinker AFB, Oklahoma (Parsons, 2006a) and at Naval Air Station Fort Worth Joint Reserves Base (Parsons, 2007). Most commercial emulsion products contain 4 to 5 percent sodium lactate by weight. The intent of adding a soluble substrate is to rapidly deplete native electron acceptors and to establish anaerobic conditions more rapidly. This may decrease the acclimation period required before reductive dechlorination of CAHs is achieved. Some commercial emulsion products also contain nutrients such as yeast extract or di-ammonium phosphate. Addition of microbial cultures can boost dechlorination rates.

Sodium bromide is a common tracer used in groundwater tracer studies. Because it is conservative (does not sorb to the aquifer matrix or does not degrade), it is usually used to determine seepage velocity. It could also be used to determine the effects of dilution on the substrate mixture. Typically measurement of TOC is used to determine substrate distribution and the use of a tracer such as bromide is optional.



#### **4.2.4 Source of Make-up Water or Chase Water**

The source of water for make-up (dilution) of an oil emulsion or for a water chase should be carefully considered. Potable water sources may be oxygenated and typically contain chlorine or chloramines to inhibit microbial activity. Neither are beneficial to stimulating anaerobic microorganisms. However, dissolved oxygen is readily consumed and any inhibition of microbial activity due to chlorine or chloramines is usually short lived. Potable water has been used at many sites without a long term impact on dechlorinating activity. Nonetheless, if feasible, the use of water high in DO should be avoided.

Two options are to treat the potable water with an oxygen scavenger, or to use native groundwater. Sodium or potassium bisulfite may be used in small concentrations (less than 5 to 10 parts per million [ppm]) to scavenge DO and transform chlorine and chloramines to chloride compounds. Care should be exercised in using these compounds, excessive amounts may lower pH and also inhibit microbial activity.

Another risk to the use of potable water is the potential for causing spreading of the plume into untreated areas. Perhaps the best option is to use native groundwater whenever possible. This reduces the potential for adverse impacts on the native microbial population and limits the net amount of displacement of groundwater, thus mitigating spread of the contaminants during injection. Many sites are mildly anaerobic to begin with, and the use of native groundwater may help achieve anaerobic conditions more quickly and limit potential acclimation periods for microbial growth and development of anaerobic populations.

#### **4.2.5 Dilution or Chase Water Volumes**

To be effective, edible oil should be distributed as uniformly as possible throughout the aquifer matrix. In practice, there is a limit to the degree that uniform distribution of substrate can be achieved due to aquifer heterogeneity and how the oil is retained within the aquifer matrix. However, the total amount of fluid to be injected is still based on using a volume equivalent to the effective porosity of the volume of aquifer to be treated with oil. For pure oil injection, a water chase is used. For emulsions, the emulsion mixture can be diluted to the desired volume or a water chase may also be used to distribute the oil droplets throughout the treatment zone.

##### **4.2.5.1 Water Chase for Pure Oil Injection**

When a water chase is injected following injection of pure edible oil, the water will tend to follow the same high permeability zones as the oil. Since water is much less viscous than edible oil, it will tend to form channels or fingers as it moves outward through regions saturated with pure oil. Friction loss through these fingers will be much lower than in the oil saturated regions, and the fingers will grow until they breakthrough out into the main part of the water saturated aquifer.

Once this break out occurs, essentially all of the water will migrate through the water saturated channels and additional flushing with water will not be effective in displacing the pure edible oil. Therefore, there is a practical limit to how much chase water can be injected to enhance oil distribution. Most of the oil may be entrapped close to the point of injection. For an application at the Hangar K site at CCAFS, Florida ([Appendix H](#)), the water chase was limited to approximately four times the volume of oil injected per point.

Therefore, the amount of water chase to use for pure oil injections is typically calculated relative to the amount of oil being injected, being limited to 3 to 5 times the volume of oil. To achieve a more uniform distribution of oil, it will be necessary to inject pure oil and the water chase on closer well spacing (*e.g.*, 5- to 10-foot centers) relative to emulsified oil products.

#### 4.2.5.2 Amount of Water Required During Emulsion Injection

Edible oil emulsions are transported in the subsurface by flowing groundwater. Consequently, water must be injected to transport the oil droplets throughout the target treatment zone. Common procedures used include: (a) injecting a concentrated emulsion followed by chase water to distribute the oil; (b) continuous injection of a more dilute emulsion; and (c) recirculation of emulsion through the treatment zone.

Modeling studies (Borden and Coulibaly, 2004) indicate that injection flow rate and concentration have essentially no effect on the final oil distribution in the sediment. The only factors that significantly influence the final oil distribution are 1) the total amount of oil injected, and 2) the total amount of water injected.

Procedures for determining the amount of oil to inject are described in [Section 4.2.2](#) and [Appendix G](#). The total water volume to inject should be equal to the effective pore volume of the target treatment zone. When installing an edible oil barrier using injection wells, the water volume injected per well can be calculated as follows:

$$\text{Injection water volume per well (V)} = (\pi) (D/2)^2 (h) (n_e) \quad (4-4)$$

Where: D is the injection well spacing  
h is the effective vertical height of the treatment zone  
n<sub>e</sub> is the effective porosity.

Typical values of effective porosity are presented in [Table 4.6](#).

The total aquifer volumes of some chlorinated solvent plumes are considerable, and there may be a practical limit to how much water and oil can be processed and injected into the formation. Thus, the thoughtful selection of a specific source treatment zone and/or barrier location represents an effective means to achieve plume containment or remediation without attempting to treat the entire plume and incurring inhibitive or unnecessary expense.

#### 4.2.6 Injection Well Spacing, Injection Intervals, and Well Design

The injection point spacing is primarily a trade off between well installation costs and labor costs. Substrate costs may also vary with spacing and the ROI required. Wider spacing of the injection points reduces injection well installation costs, but typically increases the time/labor required for injection. The well installation costs are affected by the geology and the depth to groundwater, while the labor costs are determined by the time required to inject the oil (which is largely a function of the aquifer permeability).

**Table 4.6**  
**Typical Values for Dry Bulk Density, Total Porosity and Effective Porosity of Aquifer Materials**

<b>Aquifer Matrix</b>	<b>Dry Bulk Density (g/cm<sup>3</sup>)</b>	<b>Total Porosity</b>	<b>Effective Porosity</b>
Clay	1.00-2.40	0.34-0.60	0.01-0.2
Peat	--	--	0.3-0.5
Glacial Sediments	1.15-2.10	--	0.05-0.2
Sandy Clay	--	--	0.03-0.2
Silt	--	0.34-0.61	0.01-0.3
Loess	0.75-1.60	--	0.15-0.35
Fine Sand	1.37-1.81	0.26-0.53	0.1-0.3
Medium Sand	1.37-1.81	--	0.15-0.3
Coarse Sand	1.37-1.81	0.31-0.46	0.2-0.35
Gravelly Sand	1.37-1.81	--	0.2-0.35
Fine Gravel	1.36-2.19	0.25-0.38	0.2-0.35
Medium Gravel	1.36-2.19	--	0.15-0.25
Coarse Gravel	1.36-2.19	0.24-0.36	0.1-0.25
Sandstone	1.60-2.68	0.05-0.30	0.1-0.4
Siltstone	--	0.21-0.41	0.01-0.35
Shale	1.54-3.17	0.0-0.10	--
Limestone	1.74-2.79	0.0-50.0	0.01-0.24
Granite	2.24-2.46	--	--
Basalt	2.00-2.70	0.03-0.35	--
Volcanic Tuff	--	--	0.02-0.35

From: AFCEE, 1995 after Walton, 1988 Domenico and Schwartz, 1990.

Note: g/cm<sup>3</sup> = grams per cubic centimeter.

If the aquifer has a high permeability, the oil will be easier to inject and the injections will take less time. Often multiple wells can be injected simultaneously to reduce the amount of time required to complete the injections. Injection tests are often done to help determine the anticipated injection flow rates and pressures and the approximate time it will take to complete the injections. Well installation and labor costs associated with injection of oil should be evaluated on a site-specific basis to determine the appropriate injection point spacing.

Biobarrier configurations are typically designed to provide 100% coverage of a desired treatment zone. However, subsurface heterogeneities will affect the distribution of the oil in the subsurface. Permeability differences will cause some zones to be over-treated and some zones to remain untreated. Groundwater flow and dispersion will provide some spreading of DOC increasing the reactive zone. However, safety factors are often used to provide overlap between the injections and minimize the potential for untreated zones. The need for a safety factor will depend on hydrogeologic complexities, the amount of available site characterization data, and site-specific concerns such as sensitive downgradient receptors. Injections are commonly designed to provide 5 to 10 percent overlap between injection points. However, depending on site-specific conditions a greater overlap may be desired.

Several alternatives may be used for injection of edible oil substrates including permanent injection wells, temporary injection points, or the use of direct-push-probes (Section 5). As

more applications of the technology are completed, more injection methods will be tested and evaluated.

#### **4.2.7 Additional Planning Considerations**

While oil injection can enhance immobilization and biodegradation of CAHs, there are some potentially negative impacts associated with oil injection including potential breakout at the injection points, groundwater mounding, adverse impacts on downgradient water quality, suppression of the groundwater pH due to excessive production of metabolic acids during the fermentation process, and potential soil gas emissions. These impacts are discussed briefly below.

##### **4.2.7.1 Oil Breakout**

Oil emulsions are typically injected through temporary or permanent wells because of the large volumes of fluid injected. Emulsions can also be injected by direct-push techniques using smaller volumes on closer injection point spacing. While high pressures are not required to inject emulsions in typical aquifer sediments, many practitioners do apply some pressure to the wellhead to increase the injection flow rate. A competent bentonite seal must be installed immediately above the injection screen to minimize the potential for upward migration of emulsion through the annulus between the casing and surrounding soil. For direct-push injection, pressures should be designed to prevent upward migration between the direct-push rod and the soil matrix.

Pure oil injection typically requires additional pressure to distribute the oil away from the injection point. Consequently, there is a greater potential for surface breakout during oil injection at the well seal or the contact between the injection rod and soil for direct-push injection.

##### **4.2.7.2 Groundwater Mounding**

The injection of either pure edible oil or an oil-in-water emulsion typically involves the use of large volumes of water to enhance distribution and increase the ROI of the product away from the point of injection. Depending on the subsurface conditions, the well spacing and the volume of material that is being injected, the design should include a plan to monitor for groundwater mounding to provide some indication of the potential for displacement of groundwater and contaminant mass from the zone of injection. Where groundwater is shallow, mounding of the groundwater table may discharge groundwater and substrate into underground utilities or to the ground surface. One method of minimizing mounding of the groundwater table is to inject into alternating wells or points in either a biobarrier or grid configuration.

##### **4.2.7.3 Effect of Oil Injection on Downgradient Water Quality**

As described in [Section 2.2](#), secondary groundwater quality (*e.g.*, color, odor, dissolved iron, manganese, turbidity, TDS, sulfides, suppressed pH) may be degraded within the oil treatment zone and for a limited distance downgradient. Elevated levels of TOC, lower redox geochemistry compared to background, and elevated levels of metabolic byproducts (*e.g.*, carbon dioxide, ferrous iron, methane) may be observed downgradient. However, because the edible oil substrate is generally not mobile after injection and the dissolved organic carbon

produced in the reaction zone is rapidly degraded, it is reasonable to expect that strongly anaerobic conditions will likewise be limited to a few hundred feet downgradient of the injection zone. Thus, at sites where downgradient groundwater quality may be of concern, a minimum distance of perhaps 300 feet or more should be maintained between injection locations and downgradient receptors. This distance may need to be greater or lesser, depending on the rate of groundwater flow and prevailing geochemical conditions.

#### **4.2.7.4 Soil Gas Emissions**

There is a potential for methane production as a result of oil injection. Highly elevated methane concentrations could potentially pose a problem when found near buildings. Therefore, soil gas monitoring should be conducted when edible oil is applied near the water table surface and in close proximity to buildings or underground utilities (*e.g.*, storm sewers). Biodegradation of the methane will occur rapidly in the presence of oxygen, and soil gas oxygen concentrations should be measured to determine if methane is likely to be biodegraded *in situ*. Soil gas carbon dioxide concentrations are also typically measured because elevated carbon dioxide levels often correlate with methane generation.

In addition to the generation of methane and carbon dioxide, the anaerobic biodegradation process may produce dechlorination products (*e.g.*, VC or CA) that are more volatile than the parent compounds. The potential for migration of these compounds into soil gas and into indoor air is also a major concern at sites where the water table is shallow and occupied buildings are present. Soil gas monitoring for these compounds should be considered if a soil vapor exposure pathway is present.

### **4.3 SOURCE AREA TREATMENT**

Special considerations when designing an edible oil application for source zone treatment include the following:

- Use of pure edible oil versus emulsified edible oil;
- Residual oil saturations and reduction in hydraulic conductivity;
- Partitioning of CAHs into the edible oil; and
- Injection intervals and well spacing in regards to distribution of contaminants and aquifer heterogeneity;

The following subsections summarize these consideration for applying pure edible oil versus emulsified edible oil for source area treatment.

#### **4.3.1 Source Area Treatment Using Pure Edible Oil**

The use of pure edible oil is only considered appropriate for source areas, while edible oil emulsions may be used for both types of treatment. The primary limitation to using pure edible oil is the ability to distribute the oil throughout the aquifer matrix. Studies of oil retention with pure oil (Coulibaly and Borden, 2004) suggest that the residual saturation may be 30 to 50 percent or more. The volume required to distribute the oil throughout the treatment zone is not likely to be practical for all but the smallest source areas.

In theory, such large residual saturations are not required for effective sequestration of PCE or TCE. For example, the partitioning coefficient for TCE listed in [Table 4.3](#) is 338, or 338 times the mass of TCE will partition into oil relative to groundwater. If even 10 percent of the aquifer pore volume were filled with oil there would be sufficient oil to partition the majority of TCE in groundwater (*i.e.*, 34 times the mass of TCE in groundwater) into the oil. In practice, uniformly distributing pure oil at such low saturations is difficult.

Applying pure edible oil at lower saturations may be still be effective, particularly at sites where a low rate of groundwater flow allows for significant diffusion of CAHs toward zones filled with oil, and for highly soluble metabolic acids from biodegradation of the oil to diffuse out into the formation to stimulate reductive dechlorination. [Appendix H.1](#) is an example where this was an effective approach at the Hangar K site at CCAFS, Florida. Based on the volume of oil injected versus the treatment zone pore volume, the oil that was injected accounts for less than 5 percent of the aquifer pore volume. The formation was a homogeneous sand and rates of groundwater flow were calculated to range from 44 to 220 ft/yr. These conditions were interpreted to allow sufficient mixing of CAHs and edible oil substrate for effective treatment due to advection and diffusion.

The site conditions encountered at the Hangar K site may be an exception. As the degree of aquifer heterogeneity or rate of groundwater flow increases, a lack of uniform distribution of edible oil or mixing between CAHs and the oil will likely limit the ability to effectively treat the entire source zone. Therefore, the use of pure edible oil should be applied only where the site is adequately characterized and the oil can be effectively distributed throughout the treatment zone.

#### **4.3.2 Source Area Treatment Using Edible Oil Emulsions**

Edible oil emulsions are much easier to distribute in the subsurface relative to pure edible oil, even when using high residual oil concentrations in excess of 10 percent of the treatment zone pore volume. Because of this, a more common and practical approach to source area treatment is to use an edible oil emulsion. For example, a field prepared vegetable oil emulsion was injected at an effective concentration of 23 percent oil for a DNAPL source at a manufacturing site in Oregon (Jacob *et al.*, 2007). A significant portion of TCE partitioned into the oil (up to 3.8 percent by weight), while complete reductive dechlorination to ethene and ethane was observed.

A similar approach was used at the Landfill 05 Site at Hickam AFB, Hawaii (Parsons, 2006b). At this site the parent CAHs consisted of 1,1,2,2-tetrachloroethane (PCA) and TCE at concentrations as high as 32,000 µg/L and 200,000 µg/L, respectively. A field prepared vegetable oil emulsion was injected into the source area in four injection points at an effective oil saturation of 14 percent. The parent chlorinated solvents (*i.e.*, TCE and 1,1,2,2-PCA) in groundwater were reduced by an order of magnitude or more within the volume of aquifer influenced by the vegetable oil injection. In some cases, it appears that the observed reduction in CAH concentrations in groundwater were due primarily to partitioning, while in other cases the observed reductions in concentrations were due to a combination of anaerobic reductive dechlorination and partitioning.

In summary, source area treatments using edible oil emulsions (either field prepared or commercial) with relatively high effective oil saturation (perhaps 10 to 25 percent of the treatment zone pore volume) may be an effective approach *in lieu* of using pure edible oil.

Care must be taken that excessive fermentation and lowering of pH does not occur; use of a buffering agent may be warranted for these types of edible oil applications.

#### **4.4 BIOBARRIERS USING EDIBLE OIL EMULSIONS**

In addition to the design factors described in Section 4.2, additional considerations when designing an edible oil application in a biobarrier configuration include spacing biobarriers for plume wide remediation and combining a biobarrier with some form of source reduction to avoid indefinite maintenance of the biobarrier(s). Without some form of source reduction, biobarriers may need to operate indefinitely. This may require re-injection of edible substrate every 3 to 5 years. If a source cannot be effectively remediated, it may be beneficial to install multiple biobarriers, particularly near the source area. As the distal portion of the dilute solute plume is remediated, only those biobarriers in close proximity to the source area will need to be maintained.

Spacing of biobarriers along the plume axis should take into account the rate of groundwater flow and travel time between the biobarriers. A primary limitation to site-wide cleanup using biobarriers is desorption of CAHs from the aquifer matrix and diffusion of CAHs out of low permeability sediments outside of the treatment zones. Therefore, several pore volumes of groundwater may need to pass through successive biobarriers before concentrations approach clean up or target concentrations. Given a biobarrier may remain effective for 3 to 4 years for each application of substrate, biobarriers for plume-wide treatment should not be more than 1 to 2 years travel time apart.

#### **4.5 DESIGN OF OIL-IN-WATER EMULSIONS**

The food industry has extensive experience producing stable oil-in-water emulsions with a uniformly small droplet size (Becher, 2001). The primary objective in developing an emulsion formulation is to generate an emulsion with small, uniform droplets that do not flocculate or coalesce. The key factors in generating the desired emulsion are 1) the oil-water interfacial tension, and 2) the mixing energy ([Appendix D](#)). Ideally, the emulsion mixture would be designed to match the site-specific conditions of the aquifer (*i.e.*, based on the adsorptive properties of the aquifer matrix).

Emulsifiers (surfactants) are used to lower the interfacial tension of the edible oil for ease and of emulsification and to stabilize the emulsion. Liquid lecithin mixtures with high hydrophile/lipophile balance (HLB) properties, polysorbates, mono- or di-glycerides, glycerol monooleate (GMO), amino acids, and common soaps are typically used to create field prepared or commercial emulsions. Examples of early field emulsion mixtures are listed on [Table D.5](#) in Appendix D. Commercial formulations for edible oil emulsions ([Appendix C](#)) contain proprietary emulsifiers, and may differ from the emulsifiers listed here.

Coulibaly and Borden (2004) evaluated several different combinations of surfactants and mixers to develop a procedure for generating stable emulsions with small, uniformly-sized oil droplets. Emulsifiers used in these experiments included modified lecithin (Centrophase C from Central Soya, Inc., now the Solae Company), and polysorbate 85 and polysorbate 80 – GMO mixtures. Testing of different differing lecithin products for oil-in-water emulsions by Central Soya, Inc. indicated a lecithin product with a high HLB is required to create a stable emulsion. The Centrophase C lecithin product (HLB <8) used by Coulibaly and Borden (2004) is not the most desirable product for this purpose. Centromix E (HLB of 12) from the

Solae Company is a more suitable product and is available commercially in a soybean oil product designed for emulsification (Textrol-BR<sup>®</sup>). This product has also been used in commercial ionic emulsion formulations by RNAS, Inc.

Emulsions can be prepared in the field through a four-step process: (1) dissolve all water soluble reagents in water; (2) dissolve all oil soluble reagents in oil; (3) emulsify the oil and water together using an appropriate mixer; and (4) inject emulsion into the subsurface. Water soluble reagents may include additional substrates such as sodium lactate or fructose, pH buffers such as sodium bicarbonate, and nutrients such as yeast extract. If abiotic degradation processes are being targeted then sulfate may be added in the form of powdered calcium sulfate (gypsum) or magnesium sulfate (Epsom salts). The ability to create an emulsion of suitable droplet size is primarily a function of the mixing energy applied. Methods for preparing edible oil emulsions in the field are described in [Section 5.2](#).

#### **4.6 COST ANALYSIS OF DESIGN OPTIONS**

The Technology Transfer Office of AFCEE chose to develop the use of edible oil for enhanced *in situ* anaerobic bioremediation as a low cost alternative to enhanced *in situ* bioremediation systems with more costly O&M requirements or using more costly substrates. The cost implications of using edible oil relative to other substrates has been described by Raymond *et al.* (2003). In general, edible oil provides a low cost, long-lasting substrate with a relatively high reducing capacity.

In addition to the cost of the edible oil substrate, the construction of injection wells and the labor required for injection are primary factors in controlling the cost of an edible oil application. To find the lowest cost solution, various design factors need to be considered and balanced during design of the edible oil system. These factors include the following:

- Limiting the size of the application by incorporation of MNA for dilute portions of the plume or as a final phase of the remedy, where appropriate.
- Spacing of multiple biobarriers for plume wide treatment (if part of the design).
- Balancing the dose (*e.g.*, percent residual oil) and the number of re-injections required to achieve sufficient lifespan while reducing adverse impacts on geochemistry or secondary water quality.
- Well spacing and installation costs versus radius of influence and injection time.
- Pressurized injections and injection rates versus time and labor for injection.

Balancing the cost of well installation versus the time and labor for injecting large volumes of substrate is a key factor in the cost of applying edible oil substrate. In practice, the rate of injection slows as the volume of injection increases. In addition, the amount of substrate required to get sufficient overlap increases with an increasing ROI. At some point, the cost of labor for injecting large volumes in a few wells spaced far apart will exceed the cost of injecting a somewhat lesser amount of substrate at a faster rate into more closely spaced injection wells. Often a pilot test or test injection of water to determine the ROI that can be achieved and the rate of injection that can be sustained is useful for determining the most cost effective injection configuration.



## SECTION 5

### METHODS FOR IMPLEMENTING THE EDIBLE OIL PROCESS

This section provides a discussion of methods used for injection of edible oil and the factors that affect the transport and distribution of pure edible oil and edible oil emulsions. The migration and ultimate distribution of edible oil in the subsurface is determined by the interaction between the aquifer and the physical and chemical properties of the oil or the oil emulsion. The scientific basis for these interactions are described in detail in [Appendix D](#). This section focuses on distribution of edible oil and edible oil emulsions in the subsurface, and the field methods used for mixing and injecting these products.

#### 5.1 DISTRIBUTION AND INJECTION OF PURE EDIBLE OIL

##### 5.1.1 Distribution of Pure Edible Oil in the Subsurface

Edible oil is immiscible with water. This means that a distinct interface between the oil and water exists wherever the two fluids are in contact. Because the oil is the non-wetting fluid, the interfaces are concave toward the water. The difference in pressure across the interface is the oil-water capillary pressure (*i.e.*, the capillary pressure is the oil pressure minus the water pressure). The oil pressure always exceeds the water pressure, so the capillary pressure is positive. *As a consequence, pure oil must be injected under pressure to force the oil to imbibe into a water-saturated aquifer.* Capillary pressure ( $P_c$ ) can be calculated by the relationship:

$$P_c = 2\sigma (\cos \theta)/r \quad (5-1)$$

where:  $\sigma$  is the oil-water interfacial tension

$\theta$  is the oil-water contact angle at sediment surfaces

$r$  is the radius of curvature of the oil-water interface

Pfeiffer (2003) measured  $\sigma$  and  $\theta$  for soybean oil, corn oil, and mixtures of these two materials with PCE and TCE. Results of these measurements are summarized in [Table 5.1](#). While there were measurable differences between different materials tested, these differences were not dramatic and are not expected to have a significant impact on the overall performance of the process. Interfacial tensions for the different mixtures of the edible oil and PCE or TCE varied between 16 to 34 dynes per centimeter (dynes/cm) and the contact angle varied between 27 and 54 degrees. These values are in the range often observed for other common NAPLs.

**Table 5.1**  
**Physical Properties of PCE, TCE, Soybean Oil, Corn Oil, and 50:50 Mixtures of Solvents and Edible Oil (Pfeiffer, 2003)**

Material	Interfacial Tension (dynes/cm)	Contact Angle (degrees)
PCE	33.7	44.2
TCE	22.9	53.9
Soybean Oil	24.5	33.0
Corn Oil	33.2	44.8
50% PCE: 50% Soy Oil	16.4	30.9
50% TCE: 50% Soy Oil	16.0	53.7
50% PCE: 50% Corn Oil	19.7	30.7
50% TCE: 50% Corn Oil	18.1	41.5

Note: The contact angle was measured on glass, actual contact angle on sediment surfaces may vary.

The excess pressure required to force oil into the sediment pore spaces is called the entry pressure and is directly related to the capillary pressure – large pores have a low entry pressure while small pores have a high entry pressure. As a consequence, when pure oil is injected into a water-wet formation the oil will preferentially occupy the largest pores and be excluded from small pores where the injection pressure at the pore throat is less than the entry pressure.

If pure edible oil is injected at a constant flow rate, the edible oil will first fill the larger pore spaces adjoining the injection point and then begin to migrate out into the formation through higher permeability channels. Since edible oils are 50 to 100 times more viscous than water, friction losses will begin to increase causing pressure to buildup inside the injection point. This pressure buildup will cause oil to flow into the smaller pore spaces, counteracting the preferential flow through the larger, higher permeability channels to some extent.

When edible oil is injected below the water table, there is a tendency for the oil to rise due to buoyancy effects. During the actual injection process, the effect of high injection pressures will greatly exceed buoyancy effects and flow will be radially away from the injection point. However, after injection ends, lateral pressure gradients will dissipate and buoyancy forces may cause the oil to begin to rise. The edible oil will continue upward until a finer grained, lower permeability layer is encountered that restricts upward migration. The oil may then pool below this lower permeability layer. If sufficient oil collects such that the buoyancy force exceeds the entry force of the lower permeability sediments, then the oil will be forced upward through the largest pore spaces of the low permeability layer.

The critical NAPL thickness ( $Z_N$ ) required for upward migration of light NAPLs from a coarse-grained material into a finer-grained material can be estimated from the relationship:

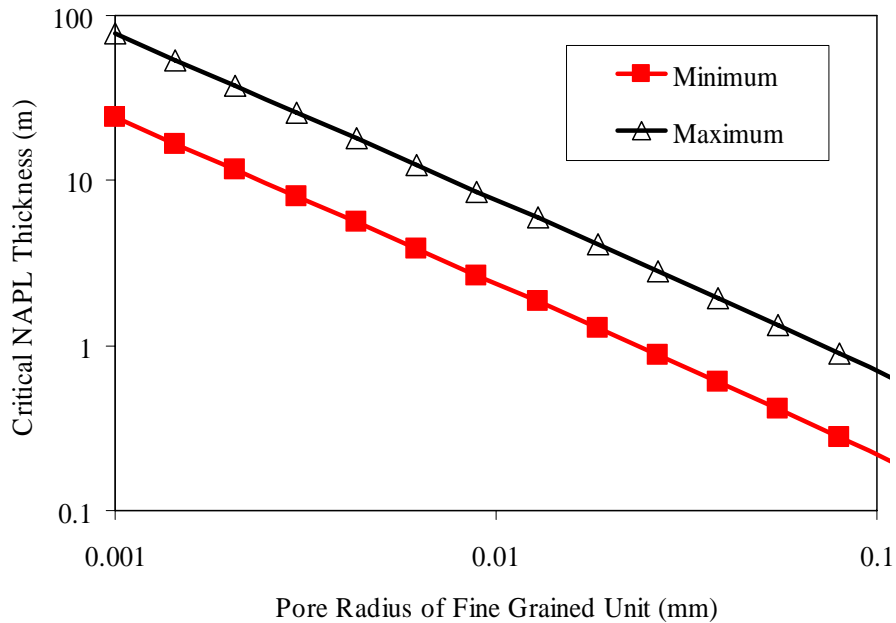
$$Z_N = 2 \sigma \cos \theta (r_F^{-1} - r_C^{-1}) / g (\rho_N - \rho_w) \quad (5-2)$$

where:  $r_F$  and  $r_C$  are the throat radius of the fine and coarse-grained materials

$g$  is the acceleration due to gravity (9.8 meters per second squared [ $m/s^2$ ])

$\rho_N$  and  $\rho_w$  are the NAPL and water density

**Figure 5.1** shows the critical NAPL thickness required for upward migration of a typical edible oil ( $\rho_N = 0.92 \text{ g/cm}^3$ ) from a coarse sand ( $r_c = 1 \text{ millimeter}$ ) into a finer grained unit. The maximum line was calculated using  $\sigma = 34 \text{ dynes/cm}$  and  $\theta = 27 \text{ degrees}$ . The minimum line was calculated using  $\sigma = 16 \text{ dynes/cm}$  and  $\theta = 54 \text{ degrees}$ . These values are based on the measurements by Pfeiffer (2003) and are thought to represent the range of values that might be expected to occur in the field. However, if microbiological processes result in substantial surfactant production, interfacial tensions can be less than 16 dynes/cm.



**Figure 5.1 Critical Edible Oil Thickness for Upward Migration as a NAPL from a Coarse Sand ( $r_c = 1 \text{ millimeter}$ ) into a Fine-grained Unit**

Results presented in **Figure 5.1** indicate that continuous layers of fine-grained silt and clay can entrap large amounts of oil, greatly limiting upward migration of the pure oil. However, if there are any preferential pathways with larger pore openings, the oil could migrate upward through these openings. Even as the oil migrates upward, a portion of the oil will be captured and retained as a residual saturation. ***The use of a water chase during injection may greatly reduce the volume of continuous phase oil available for upward migration, and is strongly recommended.***

As pure edible oil fills the aquifer pore spaces, it greatly reduces hydraulic conductivity and reduces the flow of water. However, as oil flows out into the formation and is replaced by chase water, the permeability to water will recover to some extent. Coulibaly and Borden (2004) measured the effect of soybean oil injection on the permeability of several different sandy sediments in standard laboratory permeameters. The sand filled permeameters were initially saturated with water and then flooded with 3 to 4 pore volumes (PV) of soybean oil followed by water until the permeability stabilized (minimum of 20 PV). These studies demonstrated that pure soybean oil can be distributed in sands with little or no clay.

However, pure soybean oil could not be forced into finer grained clayey sand with the equipment available. These results are consistent with the theoretical results presented above which indicate that pure oil can be easily injected into sands. However, it will be much more difficult to force oil into finer-grained sediments. Also, viscous forces may limit the ability move pure oil more than a few feet away from injection points in lower permeability materials.

Soybean oil residual saturation after flushing with over 20 PV of water varied from 22 to 54 percent for the three sands tested (Table 5.2). Residual saturation was lowest in the most uniform material (Ottawa sand) and highest in the more broadly graded concrete sand. This is consistent with the results of Chatzis and Morrow (1984) who observed that a broader grain size range leads to a higher residual saturation. For the three sands tested, the final permeability after over 30 PV of water displacement was just below half of the initial permeability, indicating that if the oil could be displaced to residual saturation, the permeability loss would not be excessive.

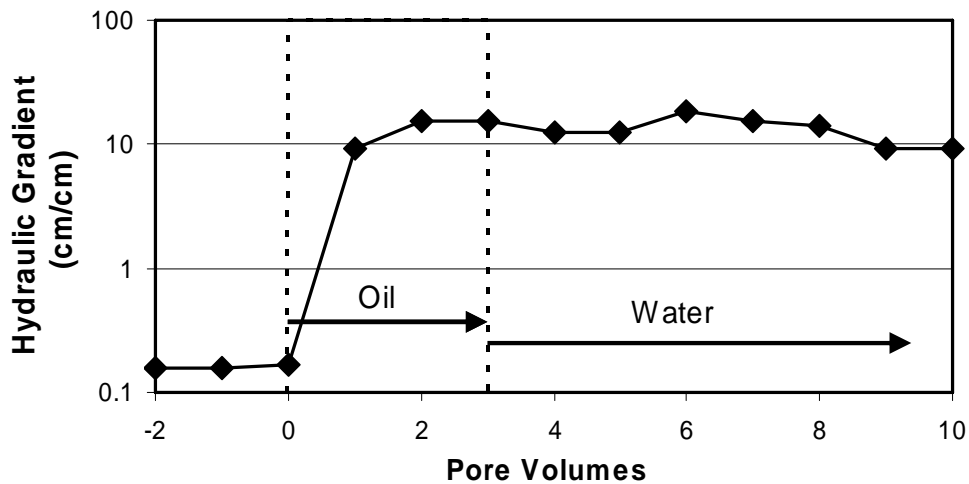
**Table 5.2**  
**Residual Saturation and Change in Hydraulic Conductivity Following Injection with Pure Soybean Oil**

Media	D <sub>50</sub> (mm)	D <sub>10</sub> (mm)	Oil Residual Saturation (% by volume of pore space)	Initial Hydraulic Conductivity (K <sub>o</sub> ) (cm/s)	Final Hydraulic Conductivity (K) (cm/s)	K/K <sub>o</sub>
Ottawa Sand	1.07	0.66	21.7 (3.7)	0.427 (0.035)	0.185 (0.057)	46 (12)
Concrete Sand	0.82	0.15	54.2 (7.9)	0.051 (0.002)	0.026 (0.007)	45 (0)
Play Sand	0.30	0.10	36.5 (2.5)	0.027 (0.006)	0.011 (0.001)	46 (18)
Concrete Sand + 5% kaolinite	0.74	0.03	31.0 (0.1)	0.019 (0.004)	0.008 (0.003)	39 (14)

Note: Residual saturation and permeability change are the average of triplicate column tests. Standard deviations are shown in parentheses.

However, extended flushing with water is required to displace the oil to residual saturation. Figure 5.2 shows the hydraulic gradient (centimeters of water head/centimeter) required to pump 2 PV of water, 3 PV of liquid soybean oil and then 7 PV of water through Ottawa sand at a constant flow rate. There is an almost two order-of-magnitude increase in the hydraulic gradient during soybean oil injection. Once the oil is displaced to residual saturation, hydraulic conductivity returns to roughly half of the pre-injection value. However, more than 7 PV of water flushing were required to achieve this.

In the field, extended flushing with water to reach residual saturation would not be practical. As a consequence, pure edible oil will not be completely displaced to residual saturation and permeability losses can be expected. Large permeability losses may be beneficial when treating source areas, since this will reduce groundwater flow through the source area and the mass discharge of contaminants. However, large permeability losses in biobarriers would not be acceptable since this will cause contaminated groundwater to flow around the biobarrier and remain untreated.



**Figure 5.2** Variation in Hydraulic Gradient during Injection through Ottawa Sand with Three Pore Volumes of Pure Soybean Oil followed by Plain Water at Constant Flow Rate

### 5.1.2 Procedures for Injection of Pure Edible Oil

Pure edible oil can be injected directly into a target treatment zone using permanent wells or through temporary direct push points. When feasible, direct push points are typically used because of their lower costs. However, direct push approaches such as Geoprobe<sup>®</sup> may be limited by the depth of penetration. CPT units may be able to achieve greater depths, but are generally more expensive. The practitioner has the option of performing multiple injections simultaneously via a manifold system for either permanent wells, temporary direct-push points, or for direct injection through the direct-push tooling. The following sections discuss the advantages and limitations of using these techniques.

#### 5.1.2.1 Injection of Pure Edible Oil Using Permanent Wells

Permanent inject injection wells using conventional drilling techniques (*e.g.*, hollow-stem auger or Rotasonic<sup>®</sup> drilling) allows for the installation of well seals that are capable of withstanding injection pressures up to several tens of pounds per square inch (psi). Two general procedures can be used to inject pure edible oil into permanent wells: (1) oil injection followed by a water chase; and (2) push-pull injection. In the water chase approach, the pure oil is first injected under pressure followed by a larger volume of water to push the oil further into the formation.

When a water chase is injected, it will tend to follow the same high permeability zones as the oil. Since water is much less viscous than edible oil, it will tend to form channels or fingers as it moves outward through the oil saturated regions. Once these fingers breakthrough out into the main part of the water saturated aquifer, essentially all of the water will migrate through the water channels and additional flushing with water will not be effective in displacing the oil. Therefore, there is a practical limit to how much chase water can be injected to enhance oil distribution ([Section 4.2.5.1](#)). The injection back pressure may

decrease when water breakthrough occurs, and injection pressures should be monitored carefully when using a water chase with pure oil.

**Figure 5.3** shows a typical oil injection system for pure soybean oil at Naval Support Activity Mid-South, Tennessee. Paired injection wells were installed with 10-foot screened intervals across two vertical horizons using a Rotosonic<sup>®</sup> drilling rig. A simple mixing and injection system was set up to control the flow rate into each well. The setup shown includes a 6,000-gallon tanker of soybean oil and two parallel injection pumps outfitted with control valves and pressure gages. Injection of the soybean oil was followed by a water chase.



**Figure 5.3 Typical Injection System Layout for Pure Edible Oil, Naval Support Activity Mid-South, Tennessee**

For injection of pure edible oil and a water chase, the annular seal must be capable of withstanding planned injection pressures. Back pressure will slowly build as the permeability of the formation is reduced by the physical presence of oil. Injection pressures and flow rates are discussed in **Section 5.2.2.3**.

Push-pull methods may also be used to inject pure edible oil. Oil is first injected under pressure to fill the pore spaces within the target zone. Following injection, free oil and groundwater are pumped back out of the injection well until oil recovery declines to negligible levels. Any oil not recovered is likely to be at residual saturation or very close to it. The primary disadvantage of this method is the recovered oil and groundwater will contain chlorinated solvents and may need to be containerized and treated. The push-pull method was used for a single well pilot test at Hangar K, CCAF, Florida, but the expanded scale test used oil injection into multiple injection points followed by a water chase. Typically injection with a water chase will be the easiest method to implement for more than just a single well pilot test.

### 5.1.2.2 Pure Oil Injection through Direct-Push Points

Perhaps the simplest method for direct injection of pure edible oil is to use a Geoprobe® or CPT direct-push rig. An example of injecting pure oil directly into an aquifer using direct-push probes at Arnold AFB, Tennessee is shown on [Figure 5.4](#). Using this method, the probe rods are pushed to the total depth of the injection interval with an expendable tip. The probe can then be disengaged from the tip exposing the open end of the probe. Free-phase oil is then pumped down the probe and injected into the aquifer as the probe is slowly drawn back up through the injection interval with the rig hydraulic system. This method requires a relatively permeable formation; otherwise, oil may migrate up the outside of the probe under high pressure. The probe may be extracted, equipped with a new expendable tip, re-driven to depth, and the process repeated for a water chase.



**Figure 5.4 Pure Edible Oil Injection through Geoprobe® Rods Using a Grout Pump**

Several commercial procedures have also been established to inject fluids into the subsurface using high-pressure, low-flow grouting probes. Many of these systems have been designed for direct injection of chemical oxidizers to remediate subsurface contaminants. These systems can be modified for edible oil injection by the commercial supplier.

### 5.1.2.3 Injection Pressure and Flow Rate

Injection pressures should be selected based on site-specific conditions. Minimum injection pressures will depend on the hydrostatic pressure and pore space entry pressure at the point of injection. Maximum injection pressures will be limited by the overburden pressure and either fracturing of the aquifer formation or compromise of the injection well seal or annular space around a direct-push probe.

To inject pure edible oil into an aquifer, the injection pressure must be greater than the hydrostatic pressure within the injection well bore. The injection pressure at the point of application will be a combination of the pressure at the well head (*i.e.*, pump pressure) and the pressure exerted by the gravity of the oil in the injection well casing. Note that the viscosity of the oil increases with decreasing temperature, making injection more difficult in cold temperatures. Therefore, the oil may need to be stored and maintained at room temperature during periods of cold weather.

The hydrostatic pressure in a fresh water unconfined aquifer is approximately 0.433 psi per foot of water column. For example, to inject oil at a depth of 10 feet below the water table would require an injection pressure in excess of 4.33 psi. For confined aquifers, the hydrostatic pressure is based on the potentiometric surface elevation, and not the saturated thickness to the overlying confining layer.

To inject over a vertical interval would require an injection pressure in excess of the hydrostatic pressure at the bottom of the injection screen. To inject oil throughout a 10-foot screened interval from 10 to 20 feet below the water table would require a minimum injection pressure of 8.66 psi. Note that the hydrostatic pressure at the top of the well screen in this case is one-half of that at the base of the well screen; thus, the oil will tend to migrate more rapidly outward through the upper portions of the well screen. This is true for injecting any fluid.

To inject pure oil into the aquifer matrix the injection pressure must also overcome the pore space entry pressure. This entry pressure will be highly variable depending on the aquifer matrix composition and heterogeneity, and the properties of the oil used. Therefore, injection pressures based on hydrostatic pressure alone are absolute minimums, and the actual pressure required to penetrate the aquifer will be somewhat higher.

Injection pressures in excess of the overburden pressure will induce hydraulic fracturing, which is generally not desirable as it will result in non-uniform distribution of oil throughout the injection zone. Overburden pressure is approximately 1.0 psi per vertical foot for most common sedimentary deposits. Given the example of an injection well screen interval from 10 to 20 feet below the water table and a depth to water of 10 feet, the overburden pressure at the top of the well screen would be approximately 20 psi. In this case, the minimum injection pressure is approximately 8.66 psi as described above, and the maximum injection pressure is approximately 20 psi. The actual injection pressure should be as close to the overburden pressure as can be safely controlled with the injection system to maximize the injection pressure at the base of the injection screened interval to obtain as uniform a distribution as possible.

In aquifers with fine-grained matrices (*e.g.*, clayey sands or silts) the pore space entry pressure may approach or exceed that of the overburden pressure. Therefore, the rate of injection may not be satisfactory in fine-grained sediments. In this case, it may be necessary to induce hydraulic fracturing by exceeding the overburden pressure. Generally, injection pressures should be slowly raised above the overburden pressure until the formation fractures as evidenced by a drop in pressure and an increase in flow rate. In general, fractures induced in unconsolidated sediment will tend to be vertical and those in consolidated sediments will tend to be horizontal (Hubbert, 1972; Hubbert and Willis, 1972). Vertical fractures could enhance vertical migration of oil, which may not always be desirable.



The distribution of oil with hydraulic fracturing will be non-uniform and relatively uncontrollable. Therefore, selection of sites with fine-grained sediments or relatively impermeable carbonate, igneous, or metamorphic rocks may not be appropriate unless fracturing of the formation is deemed desirable. Sites with well-defined fracture patterns are an exception, where distribution of the oil may be accurately predicted. Few projects have been reported where pure oil was injected into tight formation under pressure with the intention of promoting fracturing. A coarse soybean oil emulsion was injected under increased pressure directly through Geoprobe<sup>®</sup> rods at Site SS015 at Travis AFB, California (Parsons, 2004a). Results supported the conclusion that in the relatively tight formation, most of the oil migrated along silty to sandy horizons in the primarily silty to clayey formation. Flow of contaminated groundwater also was limited to horizons of higher hydraulic conductivity and the application was effective in reducing groundwater contaminant concentrations throughout the treatment zone.

## **5.2 INJECTION AND DISTRIBUTION OF EDIBLE OIL EMULSIONS**

Edible oil can be distributed in aquifers as oil-in-water emulsions followed by a water chase to enhance the distribution of the oil, or the emulsion can be simply be diluted to the desired total volume. Oil-in-water emulsions are miscible with water so the emulsions easily disperse with groundwater after injection. As the oil droplets are transported through the aquifer pore spaces by flowing groundwater, they collide with sediment surfaces and sorb to the aquifer matrix, or are entrapped within pore spaces smaller than the emulsion droplet size. The sediment surfaces gradually become coated with a layer of oil droplets that provides a carbon source for long-term reductive dechlorination.

For the best transport, the emulsion should be stable (*e.g.*, non-coalescing); have small, uniform droplets to allow transport in most aquifers; and have a neutral or negative surface charge to reduce droplet capture by the solid aquifer matrix. Conversely, in coarse grained sediments with little organic material it may be beneficial to use an ionic emulsifier to enhance sorption and oil retention.

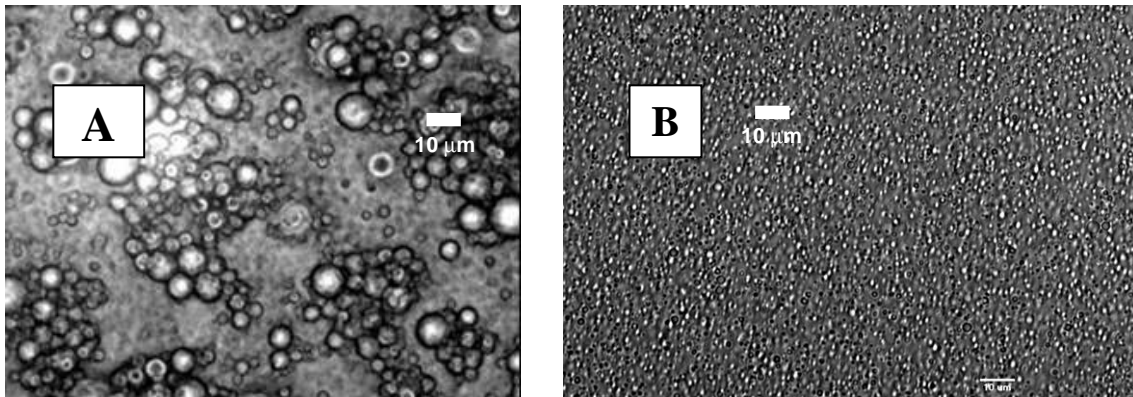
### **5.2.1 Preparation of Oil-in-Water Emulsions**

Emulsions can be prepared in the field or a pre-emulsified commercial product may be used. An emulsion prepared in the field usually follows a four-step process: (1) dissolve all water soluble reagents in water; (2) dissolve all oil soluble reagents in oil; (3) emulsify the oil and water together using an appropriate mixer; and (4) inject emulsion into the subsurface. Note that it will be more difficult to prepare a field emulsion in cold weather due to the increasing viscosity of the oil product with lower temperatures. Approaches used to emulsify the oil and water in the field may include: (1) multiple passes through a static in-line mixer; (2) repeated pumping through a high-speed centrifugal pump; (3) a single pass through a high shear mixer (*e.g.*, Silverson Model 150/250 MS, East Longmeadow, Massachusetts); and (4) multiple passes through a high shear mixer.

Mixing with a static in-line mixer or a centrifugal pump is simpler to implement in the field, but generates a relatively coarse emulsion with oil droplets on the order of 5 to 30 microns. This may be suitable for well sorted sandy sediments, but distribution of an emulsion in finer grained sediments will benefit from use of smaller droplet sizes. Use of emulsions with small oil droplets (less than 1 to 2 micron) is preferred because these emulsions are easier to distribute in most aquifers with less permeability loss and associated

pressure build up. A high shear mixer generates an emulsion with smaller, more uniformly size oil droplets. However, high shear mixers are large pieces of equipment that can be cumbersome to use in the field. This may not be a practical approach for pilot tests or for smaller applications.

An alternative to on-site preparation of an edible oil emulsion is to use a pre-mixed commercial emulsion (see [Appendix C](#) for a list of vendors). Typically, a pre-mixed emulsion is provided as a concentrate and then diluted in the field using an on-site source of water (preferably groundwater). Pre-mixed emulsions are prepared under higher quality control conditions resulting in a more precise mix of the emulsion ingredients and a more controlled droplet size. [Figure 5.5](#) shows the difference in droplet size between an emulsion prepared in the field and a pre-mixed emulsion.



**Figure 5.5 Photomicrographs of Emulsions: (A) Produced in the Field with a High Shear Mixer and (B) a Pre-Mixed Emulsion (White scale bar is 10 microns)**

Pre-mixed emulsions are easier to handle in the field, require less equipment, and the amount of labor associated with preparation and injection is reduced. Commercial emulsions are concentrated and still require dilution and mixing with makeup water in the field. Pound for pound the materials cost for purchase of the pre-mixed emulsions is higher than the cost to purchase the raw materials for preparing emulsions in the field. However, the cost of equipment and labor to prepare field emulsions must be considered when evaluating the economics of using commercial emulsions.

Some emulsion suppliers also include more easily degradable soluble substrates and nutrients (*e.g.*, lactate and yeast extract) to stimulate rapid initial growth of dechlorinating microorganisms. The practitioner may easily modify the composition of the emulsion product by adding water soluble amendments during dilution and mixing of the emulsion product with make-up water in the field.

### **5.2.2 Procedures for Injection of Edible Oil Emulsions**

Projects involving injection of edible oil emulsions typically, but not always, involve the following steps: (1) installation of injection wells and injection system manifold; (2) emulsion preparation; and (3) emulsion and chase water injection. Edible oil emulsions may also be injected using direct-push techniques. Typically several direct-push rods and injection tooling are driven and injection occurs simultaneously using an injection manifold.

### 5.2.2.1 Injection System Setup

**Figure 5.6** shows the layout of an injection system used with a field prepared emulsion at Altus AFB, Oklahoma. The process used conventionally-drilled injection wells, located 5 feet on-center, that were installed in a linear, biobarrier configuration. A simple mixing and injection system was set up to control the flow rate into each well. A polyethylene vertical tank stored make-up water. The temporary aluminum mixing tank (*i.e.*, a locally purchased farm trough) was used for blending individual ingredients brought to the site which included soybean oil, emulsifiers, sodium lactate, and yeast extract. The mixture was passed through a high-speed shear mixer and re-circulated in the mix tank. Once the emulsion was prepared it was injected simultaneously into three injection wells at a time.



**Figure 5.6 Typical Injection System Using a Field Prepared Emulsion, Altus AFB, Oklahoma**

A similar design was used at Edwards AFB. A process flow diagram from this project is shown as **Figure 5.7**. At this site, four conventionally-drilled wells, located 7.5 feet on-center and screened from 45 to 65 feet bgs, were injected simultaneously. The emulsion was prepared from soybean oil and lecithin emulsifier blended on site using treated groundwater obtained from a nearby air stripping remediation system. The emulsion was injected under 10 psi of pressure and chased with additional groundwater to increase distribution.

The use of a pre-manufactured emulsion concentrate eliminates the need for a mixer in the field and provides for a higher degree of quality control of the emulsion mixture and droplet size. The emulsion product must still be diluted in the field, but the emulsion products disperse readily in water. Automatic dosing systems (dosimeters) may be used to mix and dilute the emulsion product to the desired concentration. An example of a dosimeter set up is shown in **Figure 5.8**.

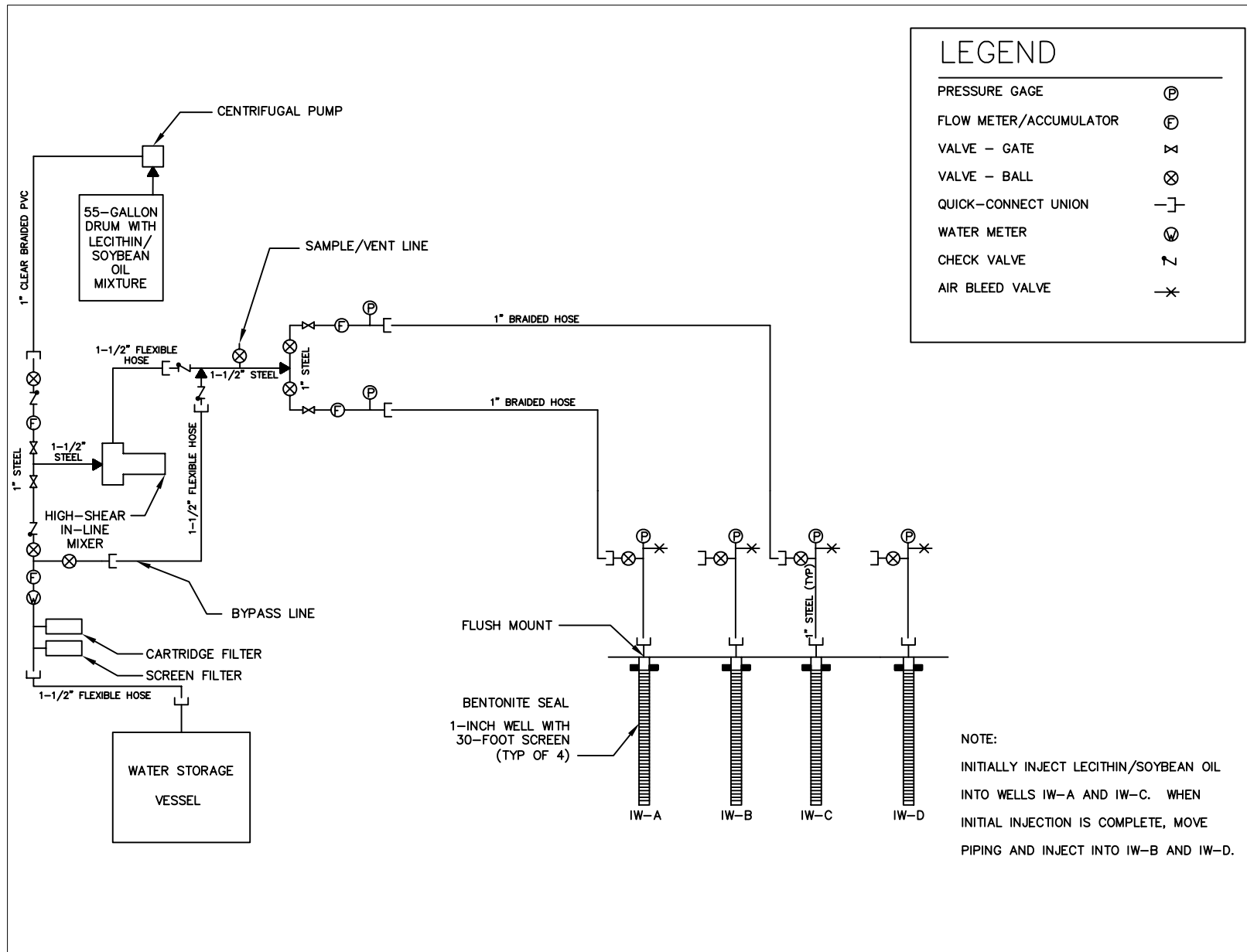


Figure 5.7 System Used to Prepare and Inject Soybean Oil-Lecithin Emulsion at Edwards Air Force Base, California



**Figure 5.8 Setup of Automatic Metering System for Dilution of Concentrated Emulsion Product** (Photo courtesy of EOS Remediation, Inc.)

These systems install directly to any available water supply line (*e.g.*, extraction well or fire hydrant) and operate without electricity, using water pressure as the power source. The emulsion concentrate is pulled directly from the supply drum, tote, or tank and is mixed with water at the set dilution rate. The water pressure forces the diluted emulsion downstream to the injection well. The desired final concentration of dilute, low viscosity emulsion (*e.g.*, 1:4 to 1:20 product to water dilutions) can be adjusted by simply dialing in the percentage by volume of emulsion to be added to the water stream. The amount of emulsion concentrate is directly proportional to the volume of water entering the system so variations in water pressure or flow rate have no effect on the dilution.

### 5.2.2.2 Emulsion Injection Wells

Emulsions can be injected through the direct-push rod and tooling, through temporary 1-inch direct-push wells, or through permanent 2-inch or 4-inch diameter wells installed using conventional drilling techniques. The selection of the most appropriate method for installing injection points depends on site-specific conditions including flow rate per well, volume of fluid that must be injected, injection pressure, and drilling costs. Injection designs are optimized to provide the maximum injection flow rate while trying to minimize the drilling cost.

Using properly prepared emulsions, it is possible to move injected emulsions up to 20 feet away from the injection point in permeable formations. However, achieving effective distribution of the emulsion often requires injecting large volumes of water. Process economics will depend on the cost for installation of each injection point and the injection flow rate that can be achieved. In many cases, it is desirable to install temporary or permanent wells that can be manifolded together to allow simultaneous injection of multiple points.

Injection wells should be thoroughly developed prior to beginning injection to obtain maximum injection rates and minimize the injection time. In addition, whether injections are

performed through permanent or temporary wells, care should be taken to install a good cement/bentonite well seal directly above the target injection interval. This will reduce surface breakout if the emulsion is injected under pressure.

Site-specific injection pressures should be estimated and wells should be constructed to withstand injection pressures (*e.g.*, greater than 10 psi). Wells are typically installed with 6 to 24 inches of polyvinyl chloride (PVC) casing projecting above grade and a glue-on threaded PVC coupling. The injection hose can then be connected directly to the injection well.

**Figure 5.9** shows a typical injection well fitting with a flow meter, shut-off valve, and pressure gauge. It is beneficial to purge air from the injection lines, as forcing air into the well screen or the formation will reduce permeability to water (*i.e.*, the emulsion mixture). Once injection is complete, the well head fitting can be removed for further use and the well locked. Permanent injection wells may cost more to install, but allow for repeated injections.



**Figure 5.9 Typical Well Head Configuration**  
(Photo courtesy of Remediation and Natural Attenuation Services, Inc.)

When the contamination extends over a significant vertical extent or across horizons with differing permeability, it may be desirable to install several shorter screened wells to target specific intervals. This allows a known quantity of emulsion to be injected in each interval. While this may increase the cost and complexity of the injection system, it is often a necessity to get effective substrate distribution.

### 5.2.2.3 Emulsion Injection Procedures

Depending on the injection well layout and formation permeability, emulsion injection can require a few hours to several days per well. As a consequence, several wells are typically injected at one time using a simple injection system manifold (**Figure 5.10**). Each injection line has a dedicated pressure gauge, air bleed valve, flow totalizer, and flow control valve.

Commercial proportional feed systems are available that allow for metered injection for up to 10 injection wells at a time (**Figure 5.11**). In this figure, the dosimeters in the foreground are used to meter in a bromide tracer solution. Such systems could also be used to meter in a soluble substrate or soluble amendment to modify the composition of the base product.



**Figure 5.10 Injection System Manifold Showing Separate Control Valve and Flow Totalizer for Each Injection Well** (Photo courtesy of EOS Remediation, Inc.)



**Figure 5.11 Proportional Feed System for a 10-Line Injection System** (Photo courtesy of Remediation and Natural Attenuation Services, Inc.)

When injecting into multiple wells, a common approach is to inject every other well at one at one time. The aquifer is allowed to rest over night and then the system is reversed to inject the remaining wells. This approach reduces the potential for excessive head buildup in the aquifer and may provide for better distribution of emulsion between the injection wells. This also minimizes potential spreading of the plume due to mounding of the water table.

Another alternative is recirculation of groundwater during injection for formations with sufficient permeability to yield groundwater at a rate that meets or exceeds the target injection rate. In addition to the benefits of using native groundwater for make-up water, recirculation may eliminate the need for large holding tanks. Lowering of the potential surface in the extraction well(s), coupled with mounding of the potentiometric surface in the injection well(s), increases the hydraulic gradient between the point of injection and the point of extraction. This can be used to control the flow of the emulsion mixture during injection. The extracted groundwater may be monitored until breakthrough occurs, at which time the recirculation may be reversed or switched to different sets of injection/extraction wells. Properly configured, recirculation arrays may enhance substrate distribution while reducing the number of wells required.

During the injection process, field personnel should regularly record the time, injection pressure, volume injected into each well, water levels in adjacent wells, visual or field observations (*e.g.*, conductivity or turbidity) of substrate or tracers in adjacent wells, and other relevant observations. Some injection wells will often accept flow more rapidly than others. When the flow meter indicates that a well has received the required volume of emulsion or chase water, the control valve is closed and flow is diverted to the remaining wells. Particular attention to the injection process should be made when pilot testing, as modifications to the injection protocol for a full-scale application may enhance substrate distribution while reducing cost.



## SECTION 6

### DATA EVALUATION AND REPORTING

Several methods are available to assess the effectiveness of using edible oil for enhanced *in situ* anaerobic bioremediation of chlorinated solvents. In all cases, multiple line of converging contaminant, hydrogeologic, geochemical, and microbial data should be used. Among these assessments are changes in contaminant concentration and mass over time, changes in groundwater geochemistry, and an increase in contaminant biodegradation rates. Protocols used to evaluate MNA (*e.g.*, USEPA, 1998; AFCEE, 2000b; AFCEE, 2003) and for enhanced anaerobic bioremediation (AFCEE *et al.*, 2004) provide references for many of these methods and techniques.

#### 6.1 CHANGES IN CONTAMINANT CONCENTRATION AND MASS

The primary objective of enhanced *in situ* anaerobic bioremediation is a decrease in contaminant concentration and mass by anaerobic degradation processes. Measurement of contaminant concentrations in groundwater both before and after edible oil addition that demonstrate a reduction in contaminant mass can be used to show that enhanced bioremediation is an effective remedy. In addition, a change in the molar ratios of parent compounds to dechlorination products can be useful in evaluating the extent to which anaerobic reductive dechlorination is occurring.

Many of these methods have been developed to evaluate MNA. The AFCEE Long Term Monitoring Decision Support Software Package with the Monitoring and Remediation Optimization System (MAROS) (AFCEE, 2003) is a useful example of computational tools used to evaluate contaminant trends and plume attenuation (accessed on the AFCEE web page at <http://www.afcee.brooks.af.mil/products/techtrans/models.asp>). Typically, trends resulting from substrate addition will be readily apparent in the immediate reaction zone. Therefore, some of these tools will more useful for determining the effects of localized treatment (*e.g.*, source reduction or a biobarrier) on greater overall plume dynamics.

It is important when evaluating the attenuation of a contaminant plume that the data demonstrate a clear and meaningful trend in contaminant concentration and/or mass over time at appropriate monitoring locations. The following sections describe some of the common considerations and methods used to determine trends in contaminant concentration and mass when using edible oil for enhanced *in situ* anaerobic bioremediation of chlorinated solvents. Both visual and mathematical methods can be used to evaluate mass reduction and plume attenuation.

### 6.1.1 Partitioning of Contaminant Mass into Edible Oil

Interpretation of trends in dissolved CAH concentrations is complicated by the effects of dissolution, sorption/desorption, and partitioning. For example, partitioning of CAH mass from the dissolved phase to the edible oil may cause an initial ‘apparent’ reduction in dissolved concentrations. The practitioner of enhanced bioremediation using edible oil should be aware of these processes when interpreting groundwater analytical results.

Because chlorinated compounds are hydrophobic, partitioning of these compounds into the edible oil is likely to occur. **Table D.1** in **Appendix D** lists experimental partitioning coefficients of chlorinated ethenes into edible oil. **Table 6.1** shows concentrations of chlorinated compounds in edible oil and groundwater in an injection well before and after injection of pure soybean oil for a pilot test site at CCAFS in Florida (Parsons, 2002a; **Appendix H**). The concentration of TCE in groundwater in the injection well dropped from 100,000 micrograms per liter (µg/L) to 84 µg/L within approximately 2 months of oil injection. The concentrations of *cis*-1,2-DCE and VC also decreased rapidly.

**Table 6.1**  
**Concentrations of Chlorinated Compounds in Vegetable Oil and Groundwater in an Injection Well at the Hangar K Site, CCAFS, Florida (Parsons, 2002a)**

Compound	Date and Concentration (µg/L)									
	6/8/99 <sup>a/</sup>		8/24/99		10/19/99		11/17/99		12/14/99	
	Oil	Water	Oil	Water	Oil	Water	Oil	Water	Oil	Water
TCE	ND	100,000	44,000	84	99,000	230	47,000	130	68,000	160
<i>cis</i> -1,2-DCE	ND	48,000	15,000	230	29,000	660	13,000	340	22,000	460
VC	ND	330	3,900	<10	<1,000	56	<1,000	<10	<1,000	<10

<sup>a/</sup> Oil injected on June 15, 1999.

ND = Not Detected

It is important that this rapid reduction in groundwater contaminant concentration not be attributed entirely to biodegradation. In this case, much of the observed reduction in contaminant concentrations was caused by partitioning of the chlorinated compounds into the edible oil. An evaluation of molar ratios may be required in this case to determine if conversion of higher chlorinated compounds to lower chlorinated compounds is occurring due to anaerobic reductive dechlorination. The following sections provide a brief discussion of several methods that are used to visualize the biological transformations that are occurring in the aquifer.

### 6.1.2 Visual Techniques for Determining Contaminant Trends

There are several ways to present data showing changes in contaminant concentrations and plume configuration over time after edible oil injection. The following subsections describe some of the common techniques available to illustrate contaminant reduction.

### 6.1.2.1 Concentration Isopleth Maps

One method consists of preparing isopleth maps of contaminant concentrations over space and/or time. Note that incomplete site characterization may bias the interpretation of isopleth maps. **Figure 6.1** shows isopleth maps of TCE in groundwater for a field test site at Travis AFB, California (Parsons, 2004b). Note that the multi-year contaminant data were collected during approximately the same seasonal time period. This is important because seasonal variations in aquifer recharge can cause significant changes in contaminant concentrations and groundwater geochemistry. **Figure 6.1** indicates that enhanced biodegradation is effective in removing TCE from the subsurface.

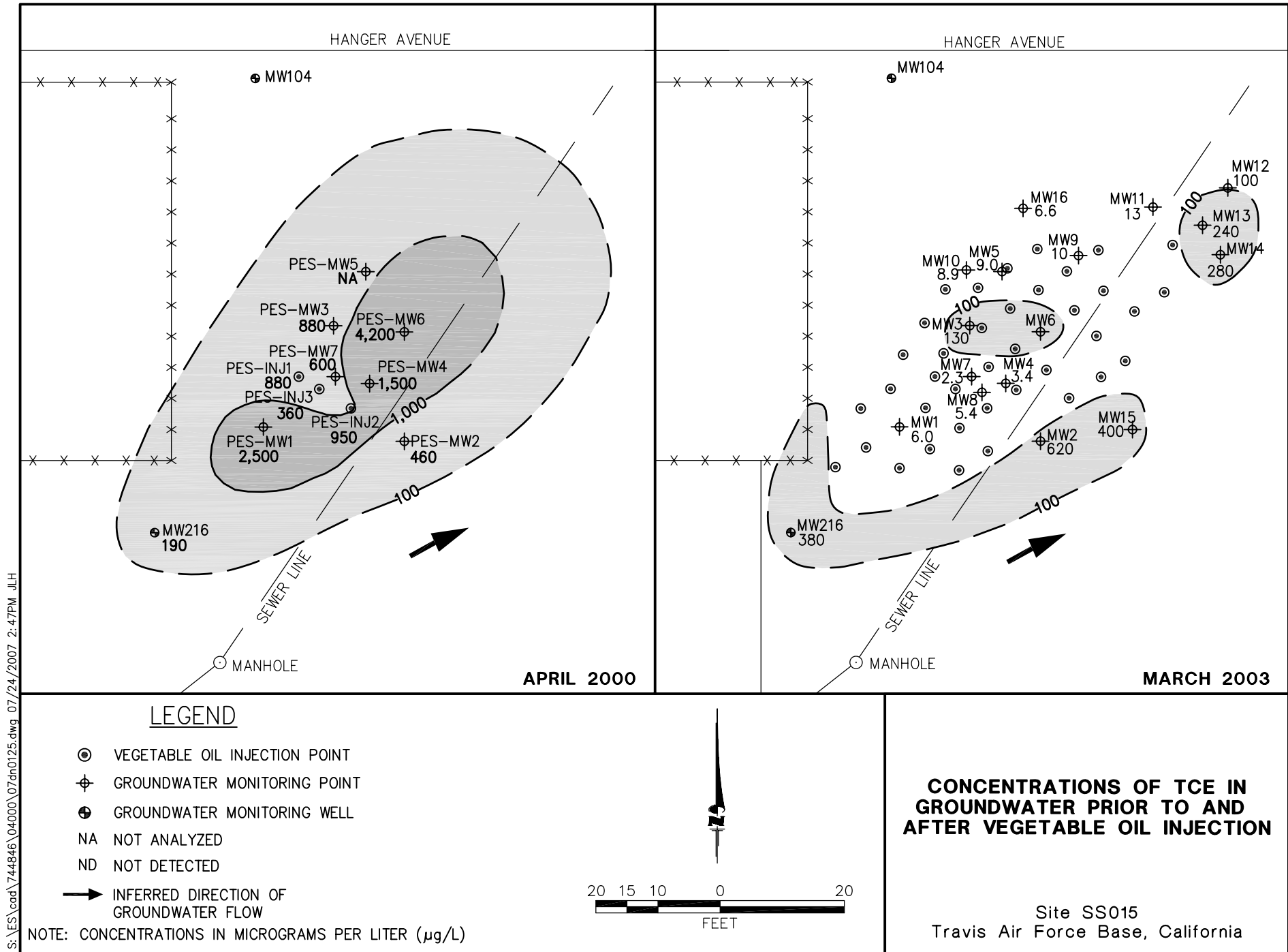
### 6.1.2.2 Concentration Versus Time and Distance Plots

A method that can be used to present data showing changes in contaminant concentrations and plume configuration is to plot contaminant concentrations versus time for individual monitoring wells, or to plot contaminant concentrations versus distance downgradient for several wells along a groundwater flow path over several sampling events. Traditional data presentations show the changes in concentration of each target compound or indicator parameter. After treatment is initiated, plots of individual contaminants including parent compounds and degradation products also can be useful in evaluating the effectiveness of the edible oil application.

Trends in the data can be analyzed by plotting concentration data versus time. Where there are high starting concentrations, data can be plotted on semi-log paper with log concentration being plotted against linear time. Plotting the concentration data on the log scale counters the relatively large changes in concentration data (*e.g.*, a concentration reduction from 1.0 mg/L to 1.0 µg/L represents a 1,000-fold reduction). **Figure 6.2** shows conceptually how concentrations of individual compounds change as sequential anaerobic reductive dechlorination proceeds. It is important to keep in mind that **Figure 6.2** is a conceptual model only.

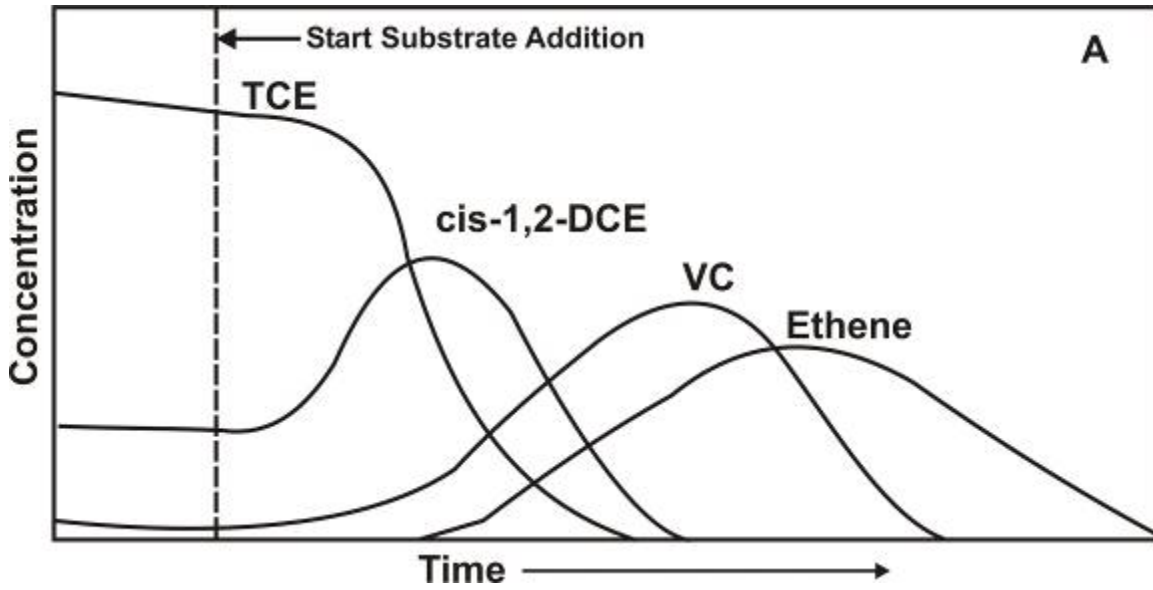
Evaluating the change in the molar concentrations and fractions (or ratios) of parent compounds to dechlorination products also can be very useful in determining the efficacy of biodegradation brought about by edible oil injection. During biodegradation, the molar ratios of the compounds involved in the reaction chain will change. Looking at molar concentrations is more accurate and informative than evaluating changes in concentration alone for the parent/dechlorination products because of the different molecular weights of the compounds. **Appendix D** provides the molecular weight of various chlorinated compounds. Calculation of molar concentrations is described in Section 6.3 of AFCEE, *et al.* (2004).

Plotting the molar fraction or ratio over time is often used when there is a constant or continuing source of contaminant mass entering a treatment zone. In this case, the total molar concentration may remain elevated or even increase because of continuing mass inputs, but an increase in the molar ratio of dechlorination products will demonstrate that sequential anaerobic reductive dechlorination is occurring (AFCEE *et al.*, 2004).



S:\ES\cad\744846\04000\07.dn0125.dwg 07/24/2007 2:47PM JLH

**Figure 6.1 Concentrations of TCE in Groundwater Prior to Injection and 3 Years After Injection at site SS-015, Travis AFB, California**



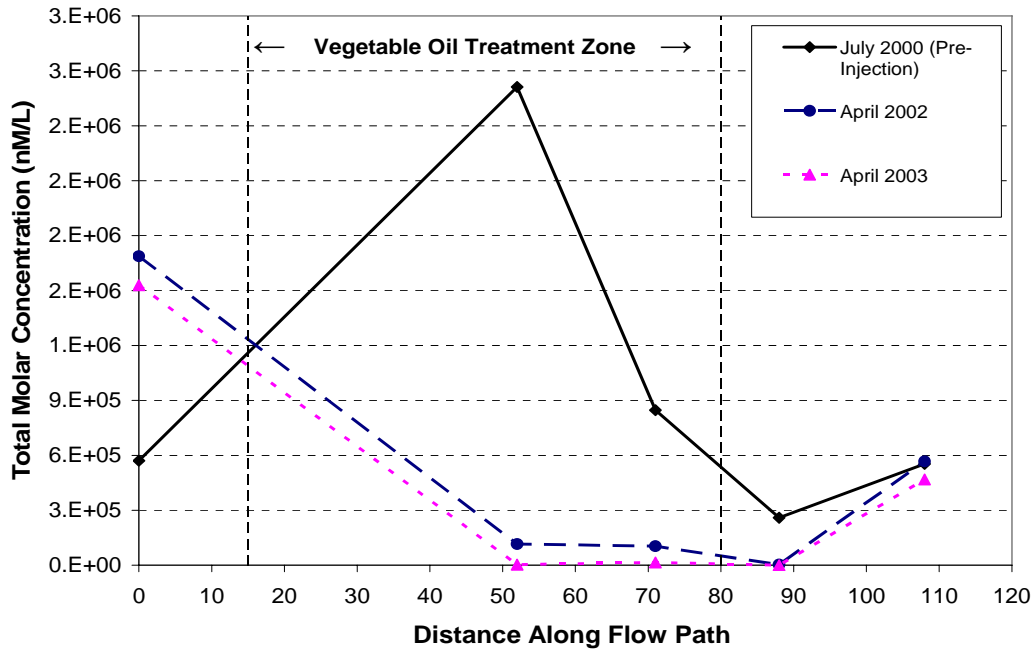
**Figure 6.2 Changes in Chlorinated Ethenes Over Time Due to Sequential Reductive Dechlorination**

By converting concentration to molar concentration and plotting these values versus distance from the treatment zone allows the practitioner to evaluate the effectiveness of the treatment and its influence along the groundwater flow path. Plotting changes to the molar fraction or total molar concentration at one location in the treatment zone is a way of determining the effectiveness of the treatment at that location.

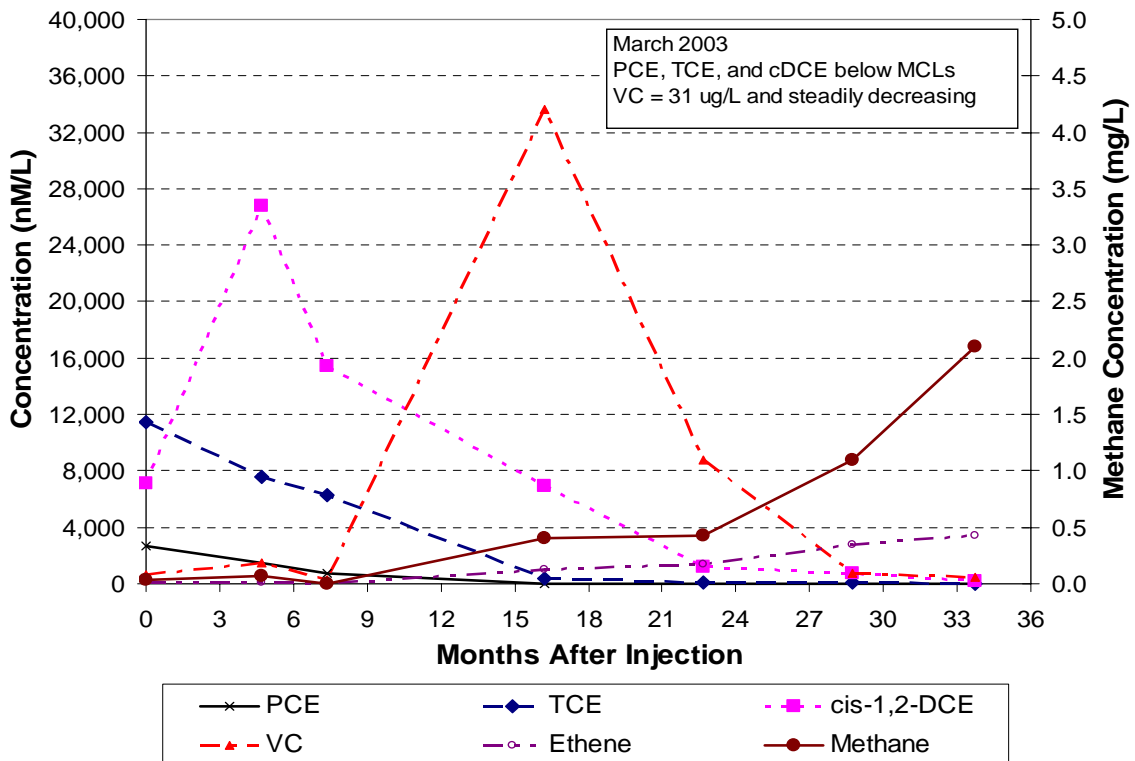
**Figure 6.3** presents a plot of total molar concentration of CAHs versus distance along the flow path through an edible oil treatment zone for three sampling events, one before edible oil injection (July 2000) and two after injection (April 2002 and April 2003). The combination of decreasing contaminant concentrations after edible oil injection shown by the plot on **Figure 6.3**, and the lack of contaminant migration provide reasonable evidence that addition of an edible oil substrate was effective in reducing CAH concentrations.

**Figure 6.4** shows data derived from a monitoring well at Travis AFB that illustrate how concentrations of individual compounds changed over time at a location where edible oil was used to stimulate sequential reductive dechlorination of chlorinated ethenes. **Figure 6.4** also points out that temporal accumulation of intermediate dechlorination products (*i.e.*, *cis*-1,2-DCE and VC) may be observed. It is important to understand that this is a natural occurrence with sequential reductive dechlorination and that a sufficient period of monitoring time must be allowed for the process to run its course.

**Figure 6.5** is an alternative presentation of data illustrating the changes in molar concentration of the target chlorinated compounds over time in a source area. The data, derived from a pilot test using emulsified oil substrate in a pilot test conducted at the Tarheel Army Missile Plant in Burlington, North Carolina averages data from four injection/monitor wells.

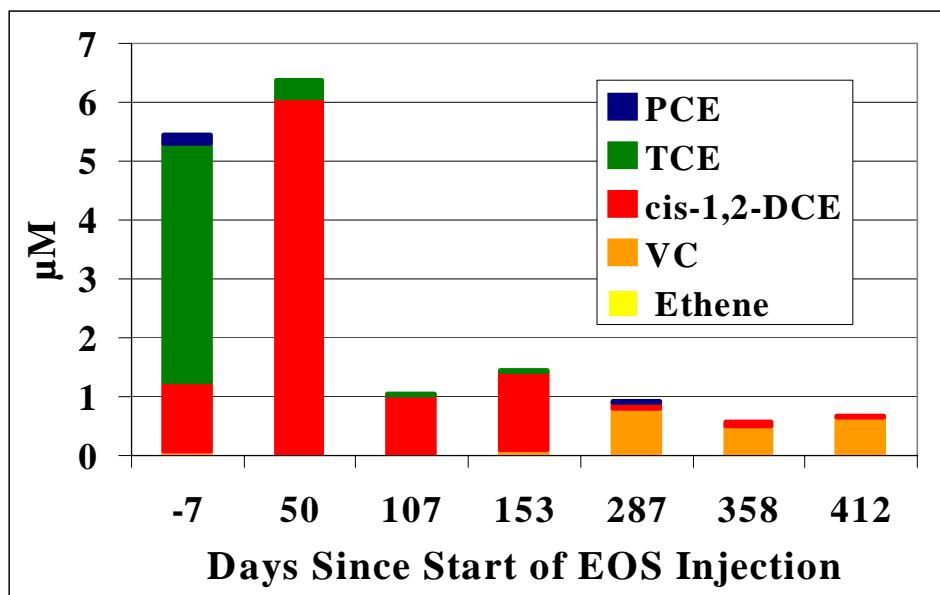


**Figure 6.3** Changes in Total Molar Concentration (PCE + TCE + DCE + VC + Ethene) Over Distance along a Central Flow Path through a Treatment Zone at CCAFS, Florida



**Figure 6.4** Changes in Concentration of Chlorinated Ethenes, Ethene, and Methane Over Time at Well MP04, Travis AFB, California (Parsons, 2004a)

The principle contaminant prior to injection of substrate was TCE with some *cis*-1,2-DCE present. Soon after injection, TCE was reduced substantially with production of *cis*-1,2-DCE. By 287 days after injection, much of the *cis*-1,2-DCE was converted to VC. The relative changes in concentrations of chloroethenes in **Figure 6.5** are consistent with the conceptual changes associated with sequential reductive dechlorination as illustrated in **Figure 6.2**. However, the sharp decrease in total molar concentration between 50 and 107 days from injection may also be indicative of an alternate attenuation mechanism (*e.g.*, biogeochemical reduction) because conservation of molar concentrations of TCE and *cis*-1,2-DCE to VC and ethene was not observed.



**Figure 6.5** Changes to Molar Concentrations of Chlorinated Compounds in Groundwater after Injection of Emulsified Oil Substrate (Solutions-IES, 2005)

### 6.1.3 Chlorine Number Plots

Chlorine number (Cl#) is another approach for evaluating the effect of anaerobic biodegradation processes, particularly the extent to which sequential degradation of PCE or TCE is occurring. Cl# is calculated as:

$$\text{Cl\#} = \frac{4 [\text{PCE}] + 3 [\text{TCE}] + 2 [\text{DCE}] + [\text{VC}]}{[\text{PCE}] + [\text{TCE}] + [\text{DCE}] + [\text{VC}] + [\text{ethene}] + [\text{ethane}] + [\text{acetylene}]}$$

where [ ] indicates concentration in moles per liter. For example, groundwater containing only TCE would have a Cl# = 3.0. However, if half of the TCE is reduced to DCE, the Cl# would decline to 2.5. When calculating Cl#, it is assumed that non-detect measurements are equal to zero and that ethene, ethane, and acetylene (due to abiotic transformation) are stable under reducing conditions. The change in Cl# to <1.0 suggests complete transformation from chlorinated parent molecules to non-chlorinated, non-toxic end products.

**Figure 6.6** shows the variation in Cl# before (November 2001) and 13 months after emulsion injection (January 2003) in a pilot test at Altus AFB Site SS-17. There was a substantial decline in Cl# in all of the injection wells following emulsion injection. In contrast, there was no significant change in Cl# in upgradient monitoring well TS-MW-1.

In the downgradient monitoring wells, the results were more variable. In TS-MW-5, the Cl# dropped from 2.17 prior to injection to 0.63 in January 2003 indicating substantial conversion of TCE to lesser-chlorinated compounds. In downgradient monitoring wells TS-MW-2 and TS-MW-3, there was no substantial change in Cl# with time due. This was due to the very low permeability of the aquifer in this area, which prevented effective distribution of organic substrate to these wells. Over the next year, the Cl# in TS-MW-2 and TS-MW-3 did gradually drop as treated water migrated into this area from the upgradient biobarrier (data not shown in **Figure 6.6**).

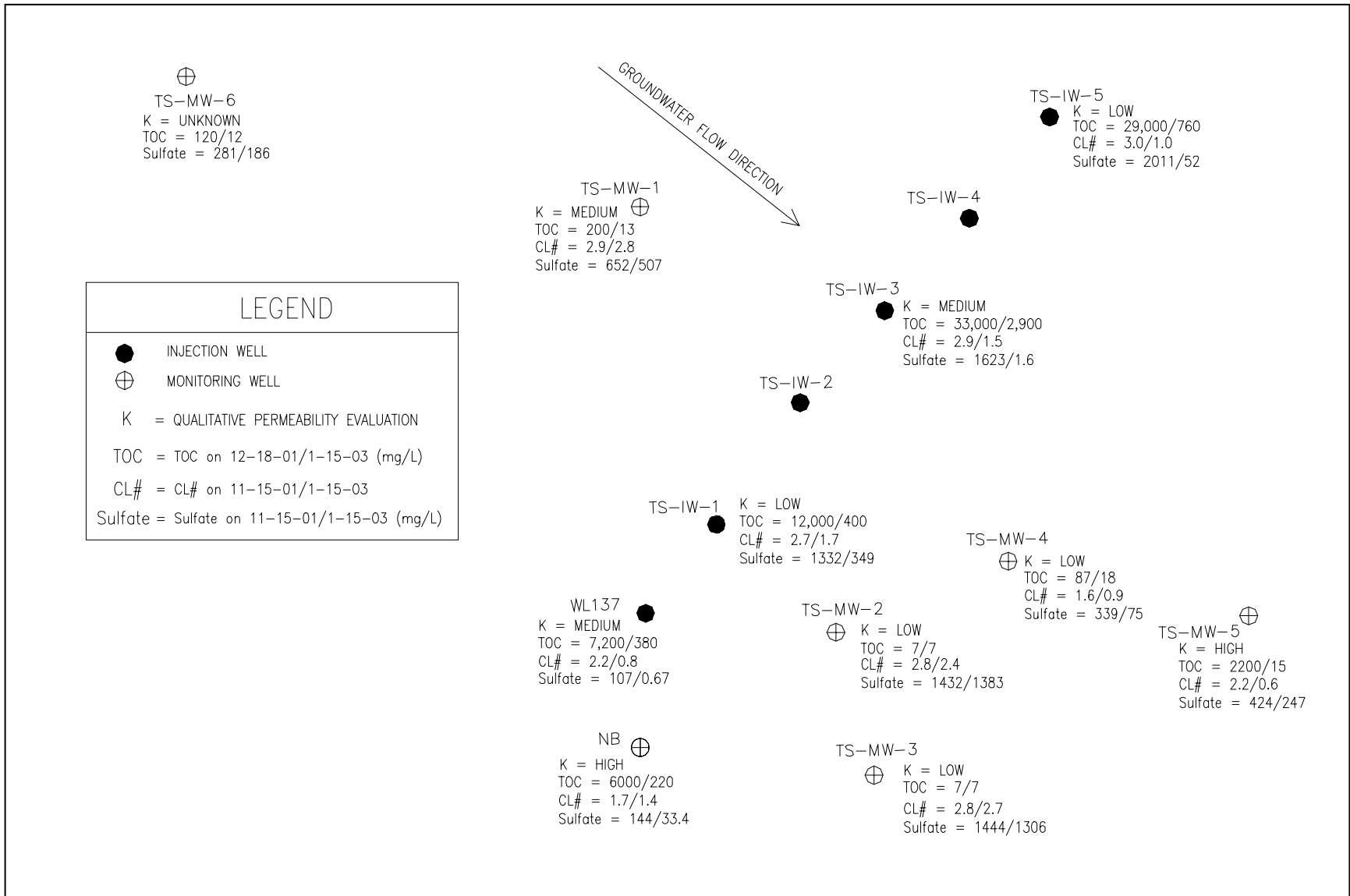
#### **6.1.4 Statistical Techniques for Determining Contaminant Trends**

The Principles and Practices document (AFCEE *et al.*, 2004; Section 6) provides an introduction to statistical techniques for determining contaminant trends. These techniques are usually intended for use in determining the effectiveness of MNA, but may be useful for evaluating the impact of a source reduction or biobarrier configuration on overall plume dynamics. The following overview of statistical methods is excerpted from the Principles and Practices document.

First, trends can be analyzed by plotting concentration data versus time, usually on semi-log paper with log concentration being plotted against linear time. Linear regression calculations can then be used to evaluate concentration trend. Discerning trends in the plotted data can be subjective process, particularly if the data do not display a uniform trend, but show some variability over time. In these cases a statistical test such as the Mann-Whitney U Test or Mann-Kendall Test can be useful. As mentioned previously, seasonal effects on contaminant concentrations should be considered in any trend analysis. Statistical methods should not be used to analyze apparent trends across data points that are not comparable. Initial comparative analyses should be conducted using data from similar hydrogeological conditions (such as seasons) and data quality. More detailed presentations of the steps required to use either the Mann-Whitney or the Mann-Kendall Tests are provided in AFCEE *et al.* (2004).

The Mann-Whitney U test (also called the Wilcoxon Rank-Sum Test) is currently being used by the State of New Jersey to determine plume stability (28 N.J.R. 1143). The test is performed using data for every contaminant at every monitoring well at a site where this plume stability test is being applied. The test is nonparametric (Mann and Whitney, 1947), which means that the test does not assume that the data are normally distributed.





**Figure 6.6 Relative Hydraulic Conductivity, TOC, Sulfate, and Chlorine Numbers throughout Altus AFB Pilot Test Plot**

The Mann-Kendall Test is another nonparametric test (Gilbert, 1987) that can be used to define the stability of a solute plume (*i.e.*, stable, diminishing, or expanding) based on concentration trends at individual wells. To evaluate plume stability or attenuation, four or more independent sampling events are required. As with the Mann-Whitney test, the Mann-Kendall test is applied to data for each contaminant of interest at each monitoring well located in plume area. This approach has limitations, as data sets can show a tremendous amount of scatter but still return the conclusion that the plume is stable (*i.e.*, no significant trend could be established statistically). To counter this problem, one can apply a more sophisticated analysis using Mann-Kendall by comparing the Mann-Kendall S statistic, a calculated confidence level, and the coefficient of variance for the sample data (Gilbert, 1987).

## 6.2 CHANGES IN GROUNDWATER GEOCHEMISTRY

Assessing biological activity at a field site based on monitoring data can be difficult. However, there are a number of monitoring parameters that can be indicative of anaerobic biodegradation processes. First, the presence of methane in the groundwater indicates that fermentation is occurring and that the potential for reductive dechlorination exists. Second, the transformation of PCE and TCE has been studied intensely and many researchers report that of the three possible DCE isomers, 1,1-DCE is the least significant intermediate and that *cis*-1,2-DCE predominates over *trans*-1,2-DCE (Barrio-Lage *et al.*, 1987, Parsons *et al.*, 1984; Parsons *et al.*, 1985). If *cis*-1,2-DCE comprises more than 80 percent of the total mass of the DCE isomers then the DCE is likely the result of biodegradation (USEPA, 1998).

This is in line with statements made by the Remediation Technologies Development Forum (RTDF) research consortium (RTDF, 1997) who reported that TCE biodegradation yields greater than 80% of the *cis*-1,2-DCE isomer (*trans*-1,2-DCE may be produced as well), while manufactured DCE is typically only 10 to 20% *cis*-1,2-DCE. Note that if 1,1,1-TCA is present at the site, then dehydrochlorination of 1,1,1-TCA will produce 1,1-DCE, which may interfere with this type of analysis. Third, because chlorinated ethenes are 55 to 85 percent chlorine by mass, the degradation of these compounds releases a large mass of chloride. Therefore, elevated chloride concentrations are also indicative of reductive dechlorination.

To summarize, the following rules-of-thumb indicate that site conditions are suitable for anaerobic reductive dechlorination to occur:

1. DO concentrations are low (less than 0.5 mg/L) and ORP is low (less than 0.0 mV),
2. Fe(II) is being produced and sulfate is depleted,
3. Methane is being produced, and
4. Hydrogen concentrations are greater than 1 nanomolar or nanomoles per liter (1 nM or nmol/L).

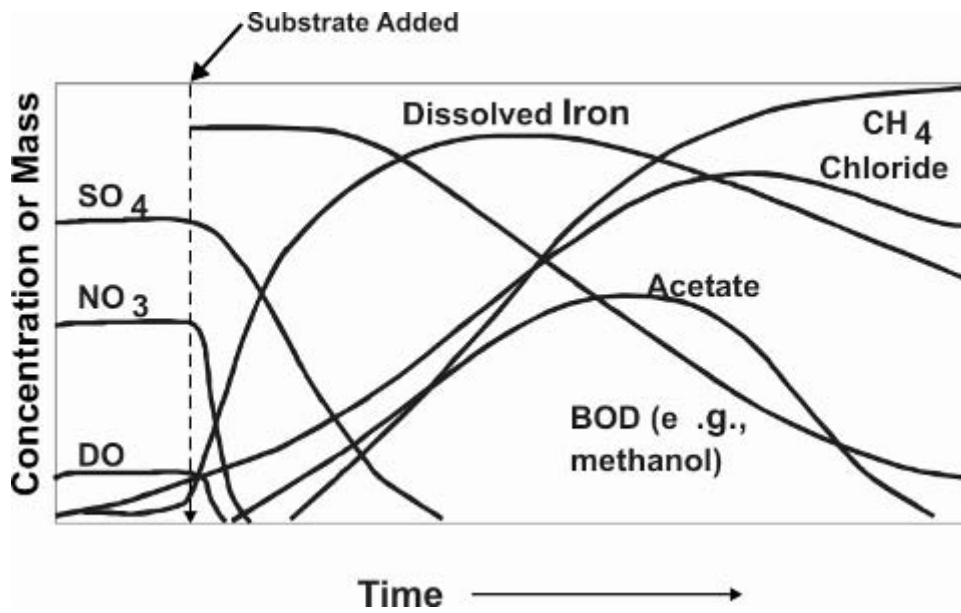
The following are site conditions that indicate anaerobic reductive dechlorination is occurring:

1. Dechlorination products are being produced (such as *cis*-1,2-DCE or VC),
2. Ethene and ethane are being produced (even low concentrations are indicative of biodegradation), and
3. Chloride concentrations are elevated.

**Table 6.2** summarizes the trends in various analyte concentrations during biodegradation. **Figure 6.7** illustrates conceptually how select geochemical parameters typically change over time after edible oil injection. The variability associated with collecting groundwater samples makes precise definitions of reactions or zones of differing oxidation-reduction potential difficult, and the various types of evidence should be weighed together to determine if edible oil addition has stimulated reductive dechlorination.

**Table 6.2**  
**Trends in Contaminant, Electron Acceptor, Metabolic Byproduct, and Total Alkalinity Concentration during Biodegradation**

<b>Analyte</b>	<b>Terminal Electron Accepting Process</b>	<b>Trend in Analyte Concentration During Biodegradation</b>
Fuel Hydrocarbons	Aerobic Respiration, Denitrification, Manganese (IV) Reduction, Iron (III) Reduction, Methanogenesis	Decreases
Highly Chlorinated Solvents and Daughter Products	Reductive Dechlorination	Parent Compounds Decrease, Daughter Products Increase Initially and then may Decrease
Lightly Chlorinated Solvents	Aerobic Respiration, Denitrification, Manganese (IV) Reduction, Iron (III) Reduction (Direct Oxidation)	Compound Concentration Decreases
Isotopic enrichment of parent compounds and dechlorination products.	Reductive Dechlorination	Changes in stable carbon isotope fractionation indicate degradation is occurring, versus a change in contaminant concentration due to non-destructive processes such as partitioning or dilution.
Changes in density of dechlorinating population density ( <i>e.g.</i> , Dehalococcoides)	Reductive Dechlorination	Increase in density (cells per liter) of dechlorinating populations.
Dissolved Oxygen	Aerobic Respiration	Decreases
Nitrate	Denitrification	Decreases
Manganese (II)	Manganese (IV) Reduction	Increases
Iron (II)	Iron (III) Reduction	Increases
Sulfate	Sulfate Reduction	Decreases
Methane	Methanogenesis	Increases
Chloride	Reductive Dechlorination or Direct Oxidation of Chlorinated Compound	Increases
ORP	Aerobic Respiration, Denitrification, Manganese (IV) Reduction, Iron (III) Reduction, Methanogenesis	Decreases
Alkalinity	Aerobic Respiration, Denitrification, Iron (III) Reduction, and Sulfate Reduction	Increases



**Figure 6.7 Changes in Select Geochemical Indicator Parameters Over Time Due to Anaerobic Biodegradation of Organic Carbon**

### 6.2.1 Native Electron Acceptors

Native electron acceptors potentially compete for substrate (*e.g.*, hydrogen) at the expense of anaerobic reductive dechlorination of CAHs. After depletion of DO, anaerobic microbes will use nitrate as an electron acceptor, followed by manganese IV [Mn(IV)], ferric iron [Fe(III)], then sulfate, and finally carbon dioxide (methanogenesis). Each sequential reaction drives the redox potential of the groundwater downward into the range within which reductive dechlorination can occur most efficiently. Some electron acceptors (DO, nitrate, and sulfate) can be measured directly in groundwater. It is easier to evaluate the use of manganese Mn(IV) and Fe(III) based on an measurement of their reduced forms, or the use of carbon dioxide by measuring the production of methane, ([Section 6.2.2.2](#)).

#### 6.2.1.1 Dissolved Oxygen

DO is the most thermodynamically favored electron acceptor used by microbes for the biodegradation of organic carbon, whether natural or anthropogenic. Anaerobic bacteria generally cannot function at DO concentrations greater than about 0.5 mg/L, and hence anaerobic reductive dechlorination will not occur. It is important to have a source of organic carbon such as edible oil in the aquifer that can be used by aerobic microorganisms as a primary substrate. During aerobic respiration, DO is depleted and concentrations will decrease.

Trends in concentrations of DO can be used to assess the effectiveness of the edible oil process, especially in areas that previously were aerobic. Depending on the amount of fermentable organic carbon already present in the aquifer, DO levels may already be depleted and addition of an organic substrate may not result in a significant change in DO concentrations across the site. Note that from a practical perspective, systematic problems with the sampling and analysis of DO are common, mainly because even a minor exposure of sampled ground water to atmospheric oxygen can cause a high bias. Conflicting data, like

elevated DO, should be viewed as primarily a sampling problem when the preponderance of other geochemical parameters suggests that anaerobic conditions exist.

#### **6.2.1.2 Nitrate**

After DO has been depleted in the microbiological treatment zone, nitrate may be used as an electron acceptor for anaerobic biodegradation of organic carbon, primarily via denitrification. In order for anaerobic reductive dechlorination of CAHs to be an efficient process, nitrate concentrations in the contaminated portion of the aquifer must be less than 1.0 mg/L. However, if nitrate is already depleted or naturally present at low concentrations, there may be little change in nitrate concentrations.

#### **6.2.1.3 Sulfate**

After dissolved oxygen and nitrate have been depleted in the microbiological treatment zone, sulfate may be used as an electron acceptor for anaerobic biodegradation. This process is termed sulfate reduction and results in the production of sulfide. Concentrations of sulfate greater than 20 mg/L may cause a substantial amount of substrate (*e.g.*, hydrogen) to be used for sulfate reduction. Sulfate must be reduced in order to reach methanogenic conditions, and high sulfate levels may lower the efficiency at which substrate is utilized for reductive dechlorination of CAHs.

However, in many plumes with high concentrations of sulfate, reductive dechlorination of CAHs can still occur. Complete reductive dechlorination has been stimulated at several high-sulfate Air Force sites using edible oil including sites at Altus AFB, Oklahoma (sulfate up to 2,200 mg/L) ([Appendix H](#)) and at Travis AFB, California (sulfate up to 5,400 mg/L). It should be recognized that multiple processes may occur (*e.g.*, biogeochemical reduction) within any enhanced bioremediation system, and that the presence of high sulfate concentrations does not necessarily preclude effective application of the edible oil process. Excessive levels of sulfides produced by reduction of sulfate can be inhibitory to microorganisms that facilitate reductive dechlorination of CAHs. This can be the case at high sulfate/low iron sites where there is insufficient iron to precipitate sulfides out of solution.

### **6.2.2 Metabolic Byproducts and Oxidation-Reduction Potential**

Depending on initial groundwater geochemistry, metabolic byproducts of biodegradation can include ferrous iron (Fe(II)), manganese II (Mn(II)), methane, ethane, ethene, increased alkalinity, chloride, reduced redox potential, dissolved hydrogen, and VFAs.

#### **6.2.2.1 Iron (II) and Manganese (II)**

In some cases, solid-phase bioavailable Fe(III) and Mn(IV) are used as electron acceptors during anaerobic biodegradation of organic carbon. During this process, Fe(III) is reduced to Fe(II), which is soluble in most groundwater systems. Similarly, Mn(IV) is reduced to soluble Mn(II). Therefore, concentrations of Fe(II) and Mn(II) in groundwater can be used as indicators of anaerobic biodegradation. Care must be taken when interpreting Fe(II) concentrations because they may be biased low by re-precipitation with sulfides.

### 6.2.2.2 Methane, Ethane, Ethene

Methanogenesis is characterized by coupled enzymatic reactions. Excess hydrogen released during substrate fermentation can be used to reduce carbon dioxide to methane. In addition, acetate may also be fermented forming carbon dioxide and methane. Methanogenesis generally occurs after oxygen, nitrate, Fe(III), and sulfate have been depleted in the treatment zone. The presence of methane in groundwater is indicative of strongly reducing conditions because methanogenic bacteria are obligate anaerobes. The presence of methane above background concentrations in areas with chlorinated solvents is an indication that the groundwater geochemical conditions are favorable for anaerobic reductive dechlorination. The fastest and most complete reductive dechlorination of CAHs typically occurs under methanogenic conditions.

Ethane and ethene are the desired end-products of the reductive dechlorination process for chlorinated ethenes and chlorinated ethanes. These light hydrocarbon gasses can be detected in groundwater at low concentrations, but tend not to accumulate as a result of diffusion into a volatile phase (gas) or as a result of further biodegradation to carbon dioxide (CO<sub>2</sub>) and water. The presence of elevated levels of ethene and ethane are favorable indicators that the biodegradation pathway for sequential reductive dechlorination is complete.

### 6.2.2.3 pH and Alkalinity

There is often a positive correlation between zones of microbial activity and increased alkalinity. Increases in alkalinity result from dissolution of carbonate mineral by carbon dioxide produced during substrate biodegradation and by reduction of iron oxide minerals. Alkalinity is important in the maintenance of groundwater pH because it buffers the groundwater system against acids generated during both aerobic and anaerobic biodegradation. A pH close to neutral (*i.e.*, 6 to 8) is the most conducive to the proliferation of healthy, diverse microbial populations. Low pH conditions (<5) are detrimental to sulfate-reducing and methanogenic bacteria. Fermentative organisms that favor lower pH conditions will compete with both sulfate reducing and methanogenic bacteria in this environment. This can result in the formation of undesirable low-molecular-weight organic byproducts of fermentation, such as ketones, alcohols, and aldehydes. Lowering of pH is more prevalent where excessive amounts of organic substrate have been applied.

Aquifer systems with lower buffering capacities are more susceptible to a decrease in pH due to biological activity. Alkalinity is an indicator of the buffering capacity of an aquifer system. From a practical standpoint, alkalinity greater than 300 mg/L are generally sufficient to buffer against adverse pH changes. Alkalinity less than 100 to 200 mg/L is a cause for concern, and pH should be monitored carefully. In such cases, pH buffering may be used during implementation to raise and/or neutralize pH against further decreases.

Buffering may be implemented using compounds such as sodium bicarbonate (NaHCO<sub>3</sub>), quicklime (CaO), dolomitic quicklime (CaO/MgO), caustic hydroxide (NaOH), and magnesium hydroxide (Mg(OH)). It is more cost effective to add these materials during the initial injection, rather than re-mobilizing to the site for an additional injection of buffering agent. Commercial emulsified oil products are now available in buffering formulations or with buffering mixtures that can be added when diluting and mixing the concentrated product.

#### 6.2.2.4 Chloride

Chloride is released to groundwater during biodegradation of CAHs. This results in chloride concentrations in the contaminant plume that are elevated relative to background concentrations. As a consequence, elevated chloride concentrations can serve as a useful indicator of reductive dechlorination. However, if substantial levels of chloride are present in the background groundwater, it may be difficult to detect small increases in chloride concentration.

Chloride ions generally do not enter into oxidation-reduction reactions, do not form important solute complexes with other ions unless the chloride concentration is extremely high, do not form salts of low solubility, are not significantly adsorbed on mineral surfaces, and play few vital biochemical roles (Hem, 1985). Thus, physical processes control the migration of chloride ions in the subsurface and chloride behaves as a conservative indicator of biological activity.

#### 6.2.2.5 Oxidation-Reduction Potential

The ORP of groundwater is a measure of electron activity (Eh) and is an indicator of the relative tendency of a solution to accept or transfer electrons. The redox of groundwater generally ranges from -400 mV to +800 mV. Oxidation-reduction reactions in groundwater containing organic compounds (natural or anthropogenic) are usually biologically mediated, and therefore, the redox of a groundwater system depends upon and influences rates of biodegradation. Knowledge of the redox of groundwater is important because some biological processes operate only within a prescribed range of redox conditions. Redox measurements can be used to provide real-time data on the location of areas undergoing anaerobic biodegradation. Due to instability, redox measurements should be taken in the field during well purging and immediately before sample acquisition using a direct-reading meter.

#### 6.2.2.6 Dissolved Hydrogen

Concentrations of dissolved hydrogen have been used to evaluate redox processes, and thus the efficiency of reductive dechlorination, in groundwater systems (Lovley and Goodwin, 1988; Lovley *et al.*, 1994; Chapelle *et al.*, 1995). The concentration of hydrogen can be used to identify groundwater where reductive dechlorination may be occurring. Hydrogen is continuously produced in anoxic groundwater systems by fermentative microorganisms that decompose natural and anthropogenic organic matter. This hydrogen is then consumed by respiratory microorganisms that use nitrate, Fe(III), sulfate, or CO<sub>2</sub> as terminal electron acceptors. This continuous cycling of hydrogen is called *interspecies hydrogen transfer*.

Significantly, nitrate-, Fe(III)-, sulfate- and CO<sub>2</sub>-reducing (methanogenic) microorganisms exhibit different efficiencies in utilizing the hydrogen that is being continually produced. Nitrate reducers are highly efficient users of hydrogen and maintain very low steady-state hydrogen concentrations. Fe(III) reducers are slightly less efficient and thus maintain somewhat higher hydrogen concentrations. Sulfate reducers and methanogenic bacteria are progressively less efficient and maintain even higher hydrogen concentrations. Because each TEAP has a characteristic hydrogen concentration associated with it, hydrogen concentrations can be an indicator of predominant redox processes. These characteristic ranges are given in [Table 6.3](#). If hydrogen concentrations are very low, reductive dechlorination is not efficient

and Type III behavior is indicated. If hydrogen concentrations are greater than approximately 1.0 nM, rates of reductive dechlorination should have environmental significance.

**Table 6.3**  
**Range of Hydrogen Concentrations for a Given Terminal Electron-Accepting Process**

TERMINAL ELECTRON-ACCEPTING PROCESS	DISSOLVED HYDROGEN CONCENTRATION		
	(nmol/L)	(atm )*	(µg/L)
Denitrification and Manganese Reduction	< 0.1	< 1.3 x 10 <sup>-7</sup>	< 2.0 x 10 <sup>-4</sup>
Iron (III) Reduction	0.2 to 0.8	0.26 - 1.0 x 10 <sup>-6</sup>	0.4 - 1.6 x 10 <sup>-3</sup>
Sulfate Reduction	1 to 4	1.3 - 5.0 x 10 <sup>-6</sup>	2.0 - 8.0 x 10 <sup>-3</sup>
Methanogenesis	5 to 20	63 - 250 x 10 <sup>-6</sup>	1.0 - 4.0 x 10 <sup>-2</sup>
<b>Optimum for Anaerobic Reductive Dechlorination</b>	<b>2 to 11</b>	<b>2.6 - 125 x 10<sup>-6</sup></b>	<b>4.0 x 10<sup>-3</sup> - 2.2 x 10<sup>-2</sup></b>

Adapted from Lovley et al., 1994; Chapelle et al., 1995; and Yang and McCarty, 1998 per AFCEE *et al.*, 2004

\* In gas phase in equilibrium with water containing dissolved hydrogen.

Redox measurements are based on the concept of thermodynamic equilibrium and, within the constraints of that assumption, can be used to evaluate redox processes in groundwater systems. The hydrogen method is based on the ecological concept of interspecies hydrogen transfer by microorganisms and, within the constraints of that assumption, can also be used to evaluate redox processes. These methods, therefore, are fundamentally different.

A direct comparison of these methods (Chapelle *et al.*, 1995) has shown that redox measurements were effective in delineating oxic from anoxic groundwater, but that redox measurements could not distinguish between nitrate-reducing, Fe(III)-reducing, sulfate-reducing, or methanogenic zones in an aquifer. In contrast, the hydrogen method could readily distinguish between different anaerobic zones. For those sites where distinguishing between different anaerobic processes is important information, hydrogen measurements are an available technology for making such distinctions. At sites where concentrations of redox sensitive parameters such as dissolved oxygen, Fe(II), sulfide, and methane are sufficient to identify operative redox processes, hydrogen concentrations are not always required to identify redox zones.

In practice, it is preferable to interpret hydrogen concentrations in the context of electron acceptor (oxygen, nitrate, Fe(III), sulfate) availability and the presence of the final products (Fe(II), hydrogen sulfide, methane) of microbial metabolism (Chapelle *et al.*, 1995). For example, if sulfate concentrations in groundwater are less than 0.5 mg/L, methane concentrations are greater than 0.5 mg/L, and hydrogen concentrations are in the 5-20 nM range, it can be concluded with a high degree of certainty that methanogenesis is the predominant redox process in the aquifer. Similar logic can be applied to identifying denitrification (presence of nitrate, hydrogen <0.1 nM); Fe(III) reduction (production of Fe(II), hydrogen 0.2 to 0.8 nM); and sulfate reduction (presence of sulfate, production of sulfide, hydrogen 1-4 nM).



Methods for measuring hydrogen in groundwater are commercially available. Hydrogen measurements can be useful, especially on sites where other parameters may not offer clear-cut indications of conditions favorable for enhanced reductive dechlorination. However, their use is limited, often due to cost of sample collection and analysis.

### 6.3 BIODEGRADATION RATE CONSTANT CALCULATIONS

If biodegradation has been stimulated by addition of edible oil, then an increase in biodegradation rates should be observed. Biodegradation rate constants should be estimated prior to substrate addition (if possible) and during performance monitoring. Biodegradation rate constant estimates can be calculated by many methods. The reader is referred to such documents as USEPA (1998) and Newell *et al.* (2003) for a detailed discussion of biodegradation rate constant estimation.

While monitoring contaminant biodegradation rates can be very useful, accurate estimation of biodegradation rate constants can be difficult due to partitioning of chlorinated solvents between the sediment, injected oil and aqueous phases. Monitoring well sample protocols tend to preferentially extract sample volume from zones of higher permeability. However, groundwater sampling results will also be influenced by the slow diffusion of contaminants out of lower permeability zones.

In contaminant source areas, there are no generally accepted methods for estimating overall average contaminant biodegradation rates. The point decay approach described by Newell *et al.* (2003) can be used to estimate rates of contaminant decline in individual monitor wells. However, these rates may not be representative of the entire treatment zone. Pure edible oil and oil-in-water emulsions are preferentially transported through the higher permeability (K) zones. As a consequence, biodegradation rates may be greater in the higher K zones than low K zones. Contaminant concentrations often decline very rapidly in monitor wells (which preferentially sample the high K zones), even though some contaminants remain in the lower permeability layers.

For a strongly heterogeneous site in the North Carolina Piedmont, Solutions-IES (2005) reported that TCE was reduced from approximately 1,000 µg/L to below detection within 50 days of emulsion injection. However, *cis*-1,2-DCE, VC, and ethene continued to be produced for over 12 twelve months indicating additional TCE was slowly diffusing out of lower permeability zones and being degraded. Slow diffusion of contaminants out of low K zones is not a problem as long as some oil remains to support contaminant biodegradation. However, if the oil is depleted before both the high and low K zones are remediated, additional oil injections may be necessary to maintain biodegradation rates.

In barrier systems, mass transfer between high and low K zones is less of an issue, and degradation rates can be calculated once geochemical and microbiological conditions stabilize. To be considered 'stable', important indicators of biogeochemical conditions (pH, ORP, DO, sulfate, methane) and contaminant biodegradation (contaminant molar ratios, Cl#) should be reasonably constant over three or more sampling events. Once conditions stabilize, degradation rates can be estimated by adjusting the rate constants in BIOCHLOR (Aziz *et al.*, 2000; 2002) until model simulations approximately match average concentrations (after conditions stabilize) in monitor wells at various locations upgradient and downgradient of the barrier. Typically, degradation rates are assumed equal to background conditions, except in areas directly impacted by edible oil (indicated by DOC > 20 mg/L). Accurate estimates of

hydraulic gradient, permeability and effective porosity will also be required for calibration of BIOCHLOR. Once accurate estimates of degradation rates are available, BIOCHLOR can be used to determine the required barrier width. Typically, a range of groundwater velocities is used in this analysis to account for seasonal variations in groundwater flow.

User's of this protocol should be aware that it may take several years after oil injection for biogeochemical and microbiological conditions to stabilize and to collect sufficient data for accurate estimation of degradation rates. If this extended data collection period is not practical, preliminary degradation rate estimates can be developed using monitoring data collected before conditions stabilize. However, these preliminary rate estimates may be lower than actual long-term degradation rates. Monitoring results from multiple sites treated with edible oil indicates that degradation rates can slowly increase over several years as the anaerobic microbial community gradually grows and adapts to the increased level of organic substrate and native electron acceptors are depleted.

#### **6.4 PROJECT REPORTING**

A detailed report should be prepared summarizing and submitting all relevant site data collected during the field test. The report should reiterate the objectives and goals of the field test and to what extent they were achieved, and whether system expansion or a full-scale application is feasible.

**Figure 6.8** provides an example outline for reporting the results of an enhanced *in situ* anaerobic bioremediation field test using edible oil. Included in this outline are an introduction and technology description, a site-specific data review, a description of system installation and oil injection, monitoring protocols and data interpretation, and conclusions and recommendations. Specific items in the report should include, but are not limited to, the following:

***Field Test Objectives:***

- Field test and data quality objectives.

***System Installation and Operation:***

- Injection system performance and any operational or safety issues of concern.
- Delivery system efficiency including flow rates, injection pressures, volumes, concentrations, and suppliers of injected reagents.
- Extent and uniformity of reagent distribution and radius of influence.
- As-built drawings and specifications.
- Cost summary.

***System Performance:***

- Organic carbon released to the aquifer system.

- Electron donor utilization rates and the efficiency of electron donor utilization for reductive dechlorination as compared to alternate biodegradation processes (*e.g.*, methane production).
- Loss of electron donor and tracer compounds, effective radii of influence, and apparent electron donor requirements.
- Electron acceptor reduction and prevailing electron accepting processes.
- Extent of anaerobic reductive dechlorination of contaminant mass, including actual/significant changes in contaminant concentrations and mass considering volatilization, dilution, degradation, and dechlorination product formation and persistence.
- Reaction kinetics and estimated biodegradation rates.
- Contributions or effects of any additional amendments added to the system (*e.g.*, secondary substrates, microbial augmentation, nutrients, or vitamins/cofactors).

***Secondary Issues:***

- Secondary impacts to water quality.
- Gas accumulation in the unsaturated zone.
- Impacts on site infrastructure and operations.

***Recommendations:***

- Feasibility and relative cost-effectiveness of the edible oil process to meet full-scale remedial objectives.
- Scale-up issues, design considerations, and mitigation or contingency measures.

Based on this information, the report should detail the overall effectiveness of the edible oil injection system and make objective recommendations regarding continued application of enhanced anaerobic bioremediation using edible oil.

**Figure 6.8 Example Table of Contents**

Acronyms and Abbreviations
Executive Summary
Section 1 – Introduction
1.1 Objectives
1.2 Scope of Work
1.3 Report Organization
1.4 Site History
1.5 Technology Description
Section 2 – Site Data Review
2.1 Hydrogeology
2.2 Historical Contaminant Results
2.2.1 Soil Gas Analytical Results
2.2.2 Soil Analytical Results
2.2.3 Groundwater Quality Data
Section 3 – Field Test Implementation
3.1 System Installation
3.1.1 Injection and Monitoring Well Sampling Locations
3.1.2 Injection and Monitoring Well Construction
3.1.3 Soil Gas Sampling Point Installation
3.2 Measurement of Baseline Geochemical Conditions and Contaminant Profiles
3.3 Substrate Addition
3.3.1 Injection System Configuration
3.3.2 Injection Volumes, Pressures, and Rates
3.3.3 Radius of Influence Testing
3.4 Aquifer Testing
3.5 Process Monitoring Protocol
Section 4 – Pilot Test Results
4.1 Site Hydrogeology
4.1.1 Groundwater Flow
4.1.2 Changes in Hydraulic Conductivity
4.2 Chlorinated Aliphatic Hydrocarbons in Groundwater
4.2.1 Pre-injection Distribution of CAHs
4.2.2 Post-injection Distribution of CAHs
4.2.3 Rates and Extent of Enhanced Anaerobic Biodegradation
Section 4 – Pilot Test Results (continued)
4.3 Biogeochemical Results
4.3.1 Electron Donors and Substrate Depletion
4.3.2 Alternate Electron Acceptors
4.3.3 Metabolic Byproducts
4.3.4 Indicator Parameters
4.4 Soil Vapor Results
4.5 Secondary Water Quality
Section 5 – Conclusions and Recommendations
Section 6 – References
Appendices
A – Analytical Results
B – Field Investigation Data

## SECTION 7

### REFERENCES

- Adrian, L., U. Szewzyk, J. Wecke, and H. Gorisch. 2000. Bacterial dehalorespiration with chlorinated benzenes. *Nature*, Vol. 408:580-583.
- Adrians, P., M.J. Barcelona, K.F. Hayes, M.L. McCormick, and K.L. Skubal. 2001. Biotic and Abiotic Dechlorination in Iron-Reducing and Sulfidogenic Environments. *Proceedings of the Sixth International Symposium on In-Situ and On-Site Bioremediation*, San Diego, California. Vol. 6(8):193-199. Battelle Press, Columbus, Ohio. June.
- Air Force Center for Environmental Excellence (AFCEE), Naval Facilities Engineering Service Center (NFESC), and the Environmental Security Technology Certification Program (ESTCP). 2004. *Principles and Practices of Enhanced Anaerobic Bioremediation of Chlorinated Solvents*. Prepared by the Parsons Corporation, Denver, Colorado. August.
- AFCEE. 1995. *Technical Protocol for Implementing Intrinsic Remediation with Long-Term Monitoring for Natural Attenuation of Fuel Contamination Dissolved in Groundwater*. Technology Transfer Division, Brooks Air Force Base, San Antonio, Texas.
- Allen H.E., G. Fu, W. Boothman, D.M. DiToro, and J.D. Mahony. 1991. *Determination of acid volatile sulfide and selected simultaneously extractable metals in sediment*. USEPA 821/R-91-100. US Environmental Protection Agency, U.S. Government Printing Office: Washington, DC.
- AFCEE. 1995. *Free Product Recovery Protocol, Revision. 2*. Air Force Center for Environmental Excellence, Brooks Air Force Base, Texas.
- AFCEE. 2000a. *Aqueous and Mineral Intrinsic Bioremediation Assessment (AMIBA) Protocol*. Prepared by Earth Science Services and Rowan University. (<http://www.afcee.brooks.af.mil/products/techtrans/monitorednaturalattenuation/amiba/mainmenu.pdf>).
- AFCEE. 2000b. *Designing Monitoring Programs to Effectively Evaluate the Performance of Natural Attenuation*. Air Force Center for Environmental Excellence, Brooks City-Base, TX.
- AFCEE. 2003. Monitoring and Remediation Optimization System (MAROS). Available at: <http://www.afcee.brooks.af.mil/products/rpo/default>
- Arnold, W.A., P. Winget, and C.J. Cramer. 2002. Reductive dechlorination of 1,1,2,2-tetrachloroethane. *Environmental Science & Technology*, Vol. 36:3536-3541.

- Aziz, C.E., C.J. Newell, J.R. Gonzales, P.E. Haas, T.P. Clement, and Y-W Sun. 2000. *BIOCHLOR – Natural Attenuation Decision Support System, User’s Manual, Version 1.0*. EPA/600/R-00/008.
- Aziz, C.E., C.J. Newell and J.R. Gonzales, 2002. *BIOCHLOR – Natural Attenuation Decision Support System, User’s Manual Addendum, Version 2.2*. Air Force Center for Environmental Excellence, Brooks City-Base, Texas. March.
- Ballapragada, B.S., H.D. Stensel, J.A., Puhakka, and J.F. Ferguson. 1997. Effect of hydrogen on reductive dechlorination of chlorinated ethenes. *Environmental Science & Technology*. Vol. 31(6): 1728-1734.
- Barrio-Lage, G., F.Z. Parsons, R.S. Nassar, and P.A. Lorenzo. 1987. Biotransformation of trichloroethene in a variety of subsurface materials. *Environmental Toxicology and Chemistry*. Vol. 6:571-578.
- Becher, P. 2001. *Emulsions: Theory and Practice*. 3rd ed. Oxford University Press, New York. 513 pp.
- Bedard, D.L., J.J. Bailey, B.L. Reiss, and G. Van Slyke Jerzak. 2006. Development and Characterization of Stable Sediment-Free Anaerobic Bacterial Enrichment Cultures that Dechlorinate Aroclor 1260. *Applied and Environmental Microbiology*, Vol. 72(4):2460-2470.
- Borden, R. C. and B. X. Rodriguez, 2006. Evaluation of Slow Release Substrates for Anaerobic Bioremediation. *Bioremediation Journal*, Vol. 10(1-2):59-69.
- Borden R.C., M.T. Lieberman and M.D. Lee. 2004. *Technology Application of Low Cost Emplacement of Insoluble Organic Substrate for Enhanced In Situ Reductive Dechlorination of Halogenated Aliphatic Hydrocarbons, Altus Air Force Base, Altus, Oklahoma*. Prepared for the Air Force Center for Environmental Excellence, Brooks City-Base, Texas.
- Bouwer, E.J., and P.L. McCarty. 1983. Transformations of halogenated organic compounds under denitrification conditions. *Applied and Environmental Microbiology*, Vol. 45:1295.
- Bouwer, E.J. and J.P. Wright. 1988. Transformations of Trace Halogenated Aliphatics in Anoxic Biofilm Columns. *Journal of Contaminant Hydrology*, Vol. 2(2):155-169.
- Bradley, P.M. 2003. History and Ecology of Chloroethene Biodegradation: A Review. *Bioremediation Journal*, Vol. 7(2):81-109.
- Bradley, P.M., and F.H. Chapelle. 1997, Kinetics of DCE and VC mineralization under methanogenic and Fe(III)-reducing conditions: *Environmental Science & Technology*, Vol. 31:2692 - 2696.
- Bradley, P.M., and F.H. Chapelle. 1996. Anaerobic mineralization of vinyl chloride in Fe (III) reducing aquifer sediments. *Environmental Science & Technology*, Vol. 30:2084-2086.
- Bradley, P.M., J.E. Landmeyer, and R.S. Dinicola. 1998a. Anaerobic oxidation of [1,2-<sup>14</sup>C]Dichloroethene under Mn(IV)-Reducing Conditions. *Applied Environmental Microbiology*, Vol. 64:1560-1562.

- Bradley, P.M., F.H. Chapelle, and J.T. Wilson. 1998b. Anaerobic mineralization of vinyl chloride in Fe(III)-reducing, aquifer sediments. *Journal of Contaminant Hydrology*, Vol. 31(1-2):111-127.
- Braus-Stromeyer, S.A., A.M. Cook, and T. Leisinger. 1993a. Biotransformation of Chloromethane to Methanethiol. *Environmental Science & Technology*, Vol. 27:1577-1579.
- Braus-Stromeyer, S.A., Hermann, R., Cook, A.M., and Leisinger, T. 1993b. Dichloromethane as the sole carbon source for an acetogenic mixed culture and isolation of a fermentative, dichloromethane-degrading bacterium. *Applied Environmental Microbiology*, Vol. 59:3790-3797.
- Brown, R.A., G.J. Skladany, J. Warner, A. Chemburkar, and D. Tisconcik. 2005. Laboratory Evaluation of Biotic/Abiotic Attenuation of Chlorinated Solvents. *Proceedings of the Eight International Situ and On-Site Bioremediation Symposium*. Baltimore, Maryland, June 2005. Paper N-17. Battelle Press, Columbus, Ohio.
- Bunge, M., L. Adrian, A. Kraus, M. Opel, W.G. Lorenz, J.R. Andreesen, H. Gorisch, and U. Lechner, 2003. Reductive dehalogenation of chlorinated dioxins by an anaerobic bacterium. *Nature*, Vol. 421:357-360.
- Butler, E.C., and K.F. Hayes. 1998. Effects of Solution Composition and pH on the Reductive Dechlorination of Hexachloroethane by Iron Sulfide. *Environmental Science & Technology*, Vol. 32(9):1276-1284.
- Butler, E.C. and K.F. Hayes. 1999. Kinetics of the transformation of trichloroethylene and tetrachloroethylene by iron sulfide. *Environmental Science & Technology*, Vol. 33: 2021-2027.
- Butler, E.C. and K.F. Hayes. 2000. Kinetics of the Transformation of Halogenated Aliphatic Compounds by Iron Sulfide. *Environmental Science & Technology*, Vol. 34(3): 422-429.
- Butler, E.C. and K.F. Hayes. 2001. Factors Influencing Rates and Products in the Transformation of Trichloroethylene by Iron Sulfide and Iron Metal. *Environmental Science & Technology*, Vol. 35(19):3884-3891.
- Campbell, T.J., D.R. Burris, A.L. Roberts, and J.R. Wells. 1997. Trichloroethylene and Tetrachloroethylene Reduction in a Metallic Iron–Water–Vapor Batch System. *Environmental Toxicology and Chemistry*, Vol. 16(4): 625–630.
- Chapelle, F.H., P.B. McMahon, N.M. Dubrovsky, R.F. Fujii, E.T. Oaksford, and D.A. Vroblesky. 1995. Deducing the distribution of terminal electron-accepting processes in hydrologically diverse groundwater systems. *Water Resources Research*, Vol. 31(2):359-371.
- Chapelle, F.H., D.A. Vroblesky, J.C. Woodward and D.R. Lovley. 1997. Practical considerations for measuring hydrogen concentrations in groundwater. *Environmental Science & Technology*, Vol. 31:2873- 2877.
- Chatzis, I. and N.R. Morrow. 1984. Correlation of capillary number relationships for sandstones. *Society Petroleum Engineering Journal*, Vol. 24:555-562.

- Chen, C., Puhakka, JA, and Ferguson, JF. 1996. Transformations of 1,1,2,2-tetrachloroethane under methanogenic conditions. *Environmental Science & Technology*. Vol.30(2):542-547.
- Coulibaly, K.M., C.M. Long, and R.C. Borden. 2006. Transport of Edible Oil Emulsions in Clayey Sands: One-Dimensional Column Results and Model Development. *Journal of Hydrologic Engineering*, Vol. 11(3):230-237.
- Coulibaly, K.M. and R.C. Borden. 2004. Impact of edible oil injection on the permeability of aquifer sands. *Journal of Contaminant Hydrology*, Vol. 71(1-4): 219-237.
- Coulibaly, K.M. 2003. *Permeability Reduction and Emulsified Soybean Oil Distribution in Aquifer Sediments: Experimental and Modeling Results*. Doctor of Philosophy in Marine, Earth and Atmospheric Sciences, North Carolina State University, Raleigh, NC.
- Cowan, D. 2000. Innovative Abatement and Remediation of Perchlorate at McGregor, Texas Weapons Plant Site. *Soil Sediment & Groundwater*, June/July, pp. 25-26.
- Cox, E.E., E. Edwards and D. Major. 2000. Natural attenuation of 1,2-dichloroethane in groundwater at a chemical manufacturing facility. In: *Remediation of Chlorinated and Recalcitrant Compounds*, Volume 2, Battelle Press. May 2000.
- Cox, E., E. Edwards, L. Lehmicke, and D.W. Major. 1995. Intrinsic biodegradation of trichloroethylene and trichloroethane in a sequential anaerobic-aerobic aquifer. *Intrinsic Bioremediation*, pp. 223-231. Columbus, Ohio, Battelle Press. Eds. Hinchee, R.E., Wilson, J.T., and Downey, D. C.
- Cox, E.E., M. McMaster, L. Lehmicke, S. Neville, and D.W. Major. 1998. Natural Attenuation of 1,2-Dichloroethane and Chloroform in Groundwater at a Superfund Site. In: Wickramanayake, G.B. and Hinchee, R.E. (Eds.), *Proceedings from the First International Conference on Remediation of Chlorinated and Recalcitrant Compounds, Natural Attenuation - Chlorinated and Recalcitrant Compounds, Monterey, CA, May 1998*. Vol. C1-3, pp. 309-314.
- Criddle, C.S., J.T. DeWitt, D. Grbic-Galic, and P.L. McCarty. 1990. Transformation of Carbon Tetrachloride by *Escherichia coli* k-12. *Applied and Environmental Microbiology*, Vol. 56:3247-3254.
- Davis, J.W. and C.L. Carpenter. 1990. The aerobic biodegradation of vinyl chloride in groundwater. *Applied and Environmental Microbiology*, Vol. 56:3878-3880.
- De Wildeman, S., A. Neumann, G. Diekert, and W. Verstraete. 2003. Growth-substrate dependent dechlorination of 1,2-dichloroethane by a homoacetogenic bacterium. *Biodegradation*, Vol. 14:241-247.
- DeBruin, W.P., Kotterman, M.J.J., M.A. Posthumus, G. Schraa, and A.J.B. Zehnder. 1992. Complete biological reductive transformation of tetrachloroethene to ethane. *Applied Environmental Microbiology*, Vol. 58(6):1996-2000.
- Devlin, J.F. and D. Muller. 1999. Field and laboratory studies of carbon tetrachloride transformation in a sandy aquifer under sulfate reducing conditions. *Environmental Science & Technology*, Vol. 33: 021-1027.



- Domenico, P.A. and F.W. Schwartz. 1990. *Physical and Chemical Hydrogeology*. John Wiley and Sons, New York, New York, 824 p.
- Duhamel, M., S.D. Wehr, L. Yu, H. Rizvi, S. Seepersad, S. Dworatzek, E.E. Cox, and E.A. Edwards. 2002. Comparison of anaerobic dechlorinating enrichment cultures maintained on tetrachloroethene, trichloroethene, *cis*-dichloroethene, and vinyl chloride. *Water Research*, Vol. 36:4193-4202.
- Dyer, M., E. Van Heiningen, and J. Gerritse. 2000. In situ bioremediation of 1,2-dichloroethane under anaerobic conditions. *Geotechnical and Geological Engineering*, Vol. 18:313-334.
- Ensign, S.A., M.R. Hyman, and D.J. Arp. 1992. Cometabolic degradation of chlorinated alkenes by alkene monooxygenase in a propylene-grown *Xanobactor* strain. *Applied and Environmental Microbiology*, Vol. 58(9):3038-3046.
- Environmental Security Technology Certification Program (ESTCP). 2005. *Bioaugmentation for Remediation of Chlorinated Solvents: Technology Development, Status, and Research Needs*. ESTCP, Arlington, Virginia. Available at <http://www.estcp.org/technology/upload/bioaugchlorinatedsol.pdf>.
- Fagervold, S.K., J.E.M. Watts, H.D. May, and K.R. Sowers. 2005. Sequential Reductive Dechlorination of *meta*-Chlorinated Polychlorinated Biphenyl Congeners in Sediment Microcosms by Two Different *Chloroflexi* Phylotypes. *Applied and Environmental Microbiology*, Vol. 71(12): 8085-8090.
- Fennell, D.E., I. Nijenhuis, S.F. Wilson, S.H. Zinder, and M.M. Häggblom, 2004. *Dehalococcoides ethenogenes* Strain 195 Reductively Dechlorinates Diverse Chlorinated Aromatic Pollutants, *Environmental Science and Technology*, Vol. 38:2075-2081.
- Fennell, D.E., A.B. Carroll, J.M. Gossett, and S.H. Zinder. 2001. Assessment of indigenous reductive dechlorinating potential at a TCE-contaminated site using microcosms, polymerase chain reaction analysis, and site data, *Environmental Science and Technology*, Vol. 35:1830-1839.
- Fennell, D. E., J.M. Gossett and S.H. Zindler. 1997. Comparison of butyric acid, ethanol, lactic acid, and propionic acid as hydrogen donors for the reductive dechlorination of tetrachloroethene. *Environmental Science & Technology*, Vol. 31(3): 918-926.
- Ferris, S., B. Henry, C. Coker, and R. Lantzy. 2006. Pilot Test Evaluation for Enhanced Anaerobic Bioremediation of Chlorinated Ethanes. *Proceedings of the Fifth International Conference on Remediation of Chlorinated and Recalcitrant Compounds*. Monterrey, California, May 2006. Paper A-1. Battelle Press, Columbus, Ohio.
- Flynn, S., F. Löffler and J. Tiedje. 2000. Microbial community changes associated with a shift from reductive dechlorination of PCE to reductive dechlorination of *cis*-DCE and VC. *Environmental Science & Technology*, Vol. 34: 1056-1061.
- Freedman, D.L., M. Lasecki, S. Hashsham and R. Scholze. 1995. Accelerated biotransformation of carbon tetrachloride and chloroform by sulfate-reducing enrichment cultures. *In: Bioremediation of Chlorinated Solvents*, R.E. Hinchee, A. Leeson, and L. Semprini (eds). Battelle Press, Columbus, Ohio.

- Freedman, D.L., and J.M. Gossett. 1989. Biological Reductive Dechlorination of Tetrachloroethylene and Trichloroethylene to Ethylene under Methanogenic Conditions. *Applied and Environmental Microbiology*, Vol. 55(9):2144-2151.
- Gander, J.W., G.F. Parkin, and M.M. Scherer. 2002. Kinetics of 1,1,1-Trichloroethane Transformation by Iron Sulfide and a Methanogenic Consortia. *Environmental Science & Technology*, Vol. 36(21):4540-4546
- Gerritse, J., Borger, A., van Heiningen, E., Rijnaarts, H., Bosma, T, Taat, J., van Winden, B., Dijk, J., and J. de Bont. 1999. Assessment and Monitoring of 1,2-Dichloroethane Dechlorination. In: *Engineered Approaches for In Situ Bioremediation of Chlorinated Solvent Contamination*. A Leeson and B.C. Alleman (Eds.). Vol. 5(2):73-79. Battelle Press, Columbus, Ohio.
- Gilbert, R.O. 1987. *Statistical Methods for Environmental Pollution Monitoring*. Van Nostrand Reinhold, New York.
- Gossett, J.M. and S.H. Zinder. 1996. Microbiological aspects relevant to natural attenuation of chlorinated ethenes. In: *Proceedings of the Symposium on Natural Attenuation of Chlorinated Organics in Groundwater*: EPA /540/R-96/509, Dallas TX, September 11-13, 1996.
- Gregory, K.B., M.G. Mason, H.D Picken, L.J. Weathers, and G.F. Parkin, G.F. 2000. Bioaugmentation of Fe(0) for the remediation of chlorinated aliphatic hydrocarbons. *Environmental Engineering Science*, Vol. 17:169-181.
- Hageman, K.J., J.D. Istok, J.A. Field, T.S. Buscheck, and L. Semprini. 2001. In situ anaerobic transformation of trichlorofluoroethene in trichloroethene-contaminated groundwater. *Environmental Science & Technology*, Vol. 35:1729-1735.
- Harkness, M.R. and R. Farnum. 2004. How Slow is Slow in Slow Release? Presented at: *Fourth International Conference on Remediation of Chlorinated and Recalcitrant Compounds*, Monterey, CA., May 2004.
- Hartmans, S., J. de Bont, J. Tramper, and K. Luben. 1985. Bacterial degradation of vinyl chloride. *Biotechnology Letters*, Vol. 7(6):383-388.
- He, J., K.M. Ritalahti, K. Yang, SS. Koenigsberg and F.E. Löffler. 2003. Detoxification of vinyl chloride to ethene coupled to growth of an anaerobic bacterium. *Nature*, Vol. 424:62-65.
- He, J., K.R. Robrock, and L. Alvarez-Cohen. 2006. Microbial Reductive Debromination of Polybrominated Diphenyl Ethers (PBDEs), *Environmental Science and Technology*, Vol. 40:4429-4434.
- He, J., Y. Sung, M.E. Dollhopf, B.Z. Fathepure, J.M. Tiedje, and F.E. Löffler. 2002. Acetate versus hydrogen as direct electron donors to stimulate the microbial reductive dechlorination process at chloroethene-contaminated sites. *Environmental Science & Technology*, Vol. 36:3945-3952.
- Hem, J.D. 1985. *Study and Interpretation of the Chemical Characteristics of Natural Water*. United States Geological Survey Water Supply Paper 2254, 264 p.

- Hendrickson, E.R., J.A. Payne, R.M. Young, M.G. Starr, M.P. Perry, S. Fahnestock, D.E. Ellis, and R.C. Ebersole. 2002. Molecular analysis of *Dehalococcoides* 16S ribosomal DNA from chloroethene-contaminated sites throughout North America and Europe. *Applied Environmental Microbiology*, Vol. 68(2):485-495.
- Henssen, M.J.C., A.W. van der Werf, S. Keuning, C. Hubach, R. Blokzijl, E. van Keulen, B. Albas, C. Haasnoot, H. Boender and E. Meijerink. 2001. Engineered fullscale bioremediation of chlorinated ethenes. In: *Proceedings of the Sixth International Symposium on In situ and On-Site Bioremediation*, San Diego, CA. Vol 6 (8): 11-17. Battelle Press, Columbus, OH. June, 2001.
- Hinchee, R.E., S.K. Ong, R.N. Miller, D.C. Downey, and R. Frandt. 1992. *Test Plan and Technical Protocol for a Field Treatability Test for Bioventing, Revision 2*. Air Force Center for Environmental Excellence, Brooks Air Force Base, Texas.
- Holliger, C., G. Schraa, A.J.M. Stams, and A.J.B. Zehnder. 1993. A highly purified enrichment culture couples the reductive dechlorination of tetrachloroethene to growth. *Applied Environmental Microbiology*, Vol. 59:2991-2997.
- Holliger, C., G. Schraa, and A.J.B. Zehnder. 1990. Reductive dechlorination of 1,2-dichloroethane and chloroethane by cell suspensions of methanogenic bacteria. *Biodegradation*, Vol. 1(4):253-261.
- Hopkins, G.D., L. Semprini, and P.L. McCarty. 1993. Microcosm and In Situ Field Studies of Enhanced Biotransformation of Trichloroethylene by Phenol-Utilizing Organisms. *Applied and Environmental Microbiology*, Vol. 59(7):2277-2285.
- Hubbert, M.K. 1972. Natural and Induced Fracture Formation. *American Association of Petroleum Geologist Memoir* 18: 235-238.
- Hubbert, M.K, and D.G. Willis. 1972. Mechanics of Hydraulic Fracturing. *American Association of Petroleum Geologist Memoir* 18: 239-257.
- Hunkeler, D., R. Aravena, K. Berry-Spark and E. Cox. 2005. Assessment of Degradation Pathways in an Aquifer with Mixed Chlorinated Hydrocarbon Contamination Using Stable Isotope Analysis. *Environmental Science & Technology*, Vol. 39:5975-5981
- Hunkeler, D., R. Aravena, and E. Cox. 2002. Carbon Isotopes as a Tool to Evaluate the Origin and Fate of Vinyl Chloride: Laboratory Experiments and Modeling of Isotope Evolution. *Environmental Science & Technology*, Vol. 36(15):3378-3384.
- Interstate Technology and Regulatory Council (ITRC) Work Group. 1998. *Technical and Regulatory Requirements for Enhanced In Situ Bioremediation of Chlorinated Solvents in Groundwater*. December 1998. (<http://www.itrcweb.org>).
- Interstate Technology and Regulatory Council (ITRC) Work Group. 1999. *Natural Attenuation of Chlorinated Solvents in Groundwater: Principals and Practices*. (<http://www.itrcweb.org>).
- Institute for Shortening and Edible Oils (ISEO). 1999. *Food Fats and Oils*, 8<sup>th</sup> Ed., Washington, DC, 40 pg (<http://www.iseo.org/foodfatsoils.pdf>).

- Jacob, C.L., B. Jonsson, H.D. Larsen, and B.A. Gilles. 2007. Full-Scale Treatment of A DNAPL Source Zone Through Injection of Food-Grade Vegetable Oil. Paper presented at the *Ninth International In Situ and On-Site Bioremediation Symposium*, Baltimore, MD. (in press). Battelle Press, Columbus, OH, June.
- Jain, V. 2000. *Hydraulic Conductivity Reduction in Surfactant-Enhanced Aquifer Remediation due to Emulsification*, Doctor of Philosophy, University of Michigan, Ann Arbor, MI.
- Jain, V. and A.H. Demond. 2002. Conductivity reduction due to emulsification during surfactant enhanced-aquifer remediation. 1. Emulsion transport. *Environmental Science & Technology*, Vol. 36:5426 -5433.
- Jung, Y. 2006. Transport of Edible Oil Emulsions in Clayey Sands: 3D Sandbox Results and Model Validation. *Journal of Hydrologic Engineering*, Vol. 11(3):238-244.
- Jung, Y. 2003. *Transport of Emulsified Edible Oil in a 3-Dimensional Sandbox: Experimental and Modeling Results*, Masters of Science in Civil Engineering, North Carolina State University, Raleigh, NC.
- Kampbell, D.H., J.T. Wilson, and S.A Vandergrift. 1989. Dissolved oxygen and methane in water by a GC headspace equilibrium technique. *International Journal of Environmental Analytical Chemistry*, Vol. 36:249-257.
- Kennedy, L., J.W. Everett, E. Becvar, and D. DeFeo. 2006. Field-scale demonstration of induced biogeochemical reductive dechlorination at Dover Air Force Base, Dover, Delaware. *Journal of Contaminant Hydrology*, Vol. 88(2006):119-136.
- Kennedy, L.G., and J. Everett. 2003. *Aqueous and Mineral Intrinsic Bioremediation Analyses (AMIBA) of the Pine Bark Mulch Permeable Barrier at Altus Air Force Base SMU-7 (OU-1)*. Draft Report prepared for the Air Force Center for Environmental Excellence, San Antonio, Texas. November.
- Kennedy L.G., J.W. Everett, K.J. Ware, R. Parsons, and V. Green, 1999. Methods for Analyzing Iron and Sulfur Minerals for Natural Attenuation Assessment with Field Examples. *Bioremediation Journal*, Vol. 3:259-275.
- Kim, Y., J.D. Istok, and L. Semprini. 2006. Push-Pull Tests Evaluating *In Situ* Aerobic Cometabolism of Ethylene, Propylene, and *Cis*-1,2-dichloroethylene. *Journal of Contaminant Hydrology*, Vol. 82 (2006): 165-181.
- Kim, Y., J.D. Istok, and L. Semprini. 2004. Push-Pull Tests for Assessing *In Situ* Aerobic Cometabolism. *Groundwater*, Vol. 42(3): 329-337.
- Klecka, E. Lutz, N.J. Klier, R.J. West, J.W. Davis, D. Ellis, J.M. Odom, T.A. Ei, F.H. Chappelle, D.Major, and J. Salvo. 1997. Intrinsic bioremediation of chlorinated ethenes at Dover Air Force Base. In: *In Situ and On-Site Bioremediation: Volume 3*. Alleman, B.C. And Leeson, A. (Eds). Battelle Press, Columbus, OH.
- Kohler-Staub, D., S. Frank, and T. Leisinger. 1995. Dichloromethane as the sole carbon source for *Hyphomicrobium* sp. strain DM2 under denitrification conditions. *Biodegradation*, Vol. 5:237-248.

- Kriegman-King, M. R. and M. Reinhard. 1994. Transformation of Carbon Tetrachloride by Pyrite in Aqueous Solution. *Environmental Science & Technology*, Vol. 28(4):692-700.
- Kriegman-King, M. R. and M. Reinhard. 1992. Transformation of Carbon Tetrachloride in the Presence of Sulfide, Biotite, and Vermiculite. *Environmental Science & Technology*, Vol. 26(11):2198-2206.
- Krone, U.E., R.K. Thauer, H.P.C. Hogenkamp, and K. Steinbach. 1991. Reductive formation of carbon monoxide from CCl<sub>4</sub> and Freons 11,12,1nd 13 catalyzed by corrinoids. *Biochemistry*, Vol. 30:2713-2719.
- Kueper, B.H., D. Redman, R.C. Starr, S. Reitsma, and M. Mah. 1993. A field experiment to study the behavior of tetrachloroethylene below the water table: Spatial distribution of residual and pooled DNAPL. *Ground Water*, Vol. 31(5): 756-766.
- Lalman, J.A. and D.M. Bagley. 2000. Anaerobic degradation and inhibitory effects of linoleic acid. *Water Resources*, Vol. 34(17):4220-4228.
- Lalman, J.A. and D.M. Bagley. 2001. Anaerobic degradation and methanogenic inhibitory effects of oleic and stearic acids. *Water Resources*, Vol. 35(12):2975-2983.
- Lang, W., S. Sokhansanj, and F.W. Sosulski. 1992. Modeling the temperature-dependence of kinematic viscosity for refined canola oil. *Journal of American Oil and Chemical Society*, Vol. 69:1054.
- Lee, M.D., M.T. Lieberman, W. Beckwith, R.C. Borden, P. Haas, E.S.K. Becvar, K. Dobson, and G.J. Sandlin. 2005. Vegetable Oil Pilots to Enhance DNAPL Sequestration and Reductive Dechlorination. In: *Proceedings of the Eight International In Situ and On-Site Bioremediation Symposium*, Baltimore, MD. Paper D-07. Battelle Press, Columbus, OH, June.
- Lee, M.D., R.C. Borden, W.J. Beckwith, T. Crotwell, and P.E. Hass. 2001. Effective distribution of edible oils- Results from five field applications. In: V.S. Magar, D. Fennell, J.L. Morse, B.C. Alleman, and A. Leeson (eds.), *Anaerobic Degradation of Chlorinated Solvents*. Volume 6(7). Battelle Press. Columbus, OH.
- Lee, M.D., R.J. Buchanan, and D.E. Ellis. 2000. Laboratory studies using edible oils to support reductive dechlorination, In: G. Wickramanayake, A. Gavaskar, B. Alleman, and V. Magar, (eds), *Bioremediation and Phytoremediation of Chlorinated and Recalcitrant Compounds*, p. 77-84.
- Lee, M.D., M.T. Lieberman, W.J. Beckwith, R.C. Borden, J.W. Everett, and L.G. Kennedy. 2003. Pilots to enhance trichloroethene reductive dechlorination and ferrous sulfide abiotic transformation. In: V.S. Magar and M.E. Kelley (eds.), *Proceedings of the Seventh International In Situ and On-Site Bioremediation Symposium*, Orlando, FL. Battelle Press, Columbus, OH, June 2003.
- Lee, W. and B. Batchelor. 2000. Abiotic Reductive Dechlorination of Chlorinated Ethylenes by Iron-bearing Soil Minerals and Potential Interactions with Biotic Processes. In *Chemical-Biological Interactions in Contaminant Fate*; Tratnyek, P. G., Adriaens, P., Roden, E. E., Eds.; *220th American Chemical Society National Meeting*; American Chemical Society: Washington, DC, pp 338-340.

- Lendvay, J.M., F.E. Löffler, M. Dollhopf, M.R. Aiello, G. Daniels, B.Z. Fathepure, M. Gebhard, R. Heine, R. Helton, J. Shi, R. Krajmalnik-Brown, C.L. Major, M.J. Barcelona, E. Petrovskis, J.M. Tiedje, and P. Adriaens. 2003. Bioreactive Barriers: A Comparison of Bioaugmentation and Biostimulation for Chlorinated Solvent Remediation. *Environmental Science and Technology*, Vol. 37(7):1422-1431.
- Lieberman, M.T., N.L. Lindow, R.C. Borden, and G.M. Birk. 2003. Anaerobic biodegradation and biotransformation using emulsified edible oil. In: Calabrese, E.J., P.T. Kosteci, and J. Dragun (eds.), *Contaminated Soils, Sediments and Water: Science in the Real World*. Springer, Vol. 9, Chapter 32, pp 485-500.
- Lindow, N.L. 2004. *Use of Soybean Oil and Soybean Products for Groundwater Bioremediation*, Master of Science Thesis, North Carolina State University, Raleigh, NC, May 2004.
- Löffler, F., Q. Sun, J. Li, and J. Tiedje. 2000. 16S rRNA gene-based detection of tetrachloroethene-dechlorinating *Desulfuromonas* and *Dehalococcoides* species. *Applied Environmental Microbiology*, Vol. 66(4):1369-1374.
- Logan, B.E. 1999. *Environmental Transport Processes*. John Wiley & Sons, New York.
- Long, C.M. 2004. *Enhanced Reductive Dechlorination in Edible Oil Barriers – Experimental and Modeling Results*, Masters of Science in Civil Engineering, North Carolina State University, Raleigh, NC.
- Long, C.M. and R.C. Borden. 2004. Enhanced reductive dechlorination in columns treated with edible oil emulsion. *Journal of Contaminant Hydrology*, July 2004.
- Lovley, D. R. and S. Goodwin. 1988. Hydrogen concentrations as an indicator of the predominant terminal electron-accepting reactions in aquatic sediments. *Geochimica et Cosmochimica Acta*, Vol. 52:2993-3003.
- Lovley, D.R., F.H. Chapelle, and J.C. Woodward. 1994. Use of dissolved H<sub>2</sub> concentrations to determine distribution of microbially catalyzed redox reactions in anoxic groundwater. *Environmental Science & Technology*, Vol. 28(7):1205-1210.
- Lu, Xiaoxia, J. Wilson, and D.H. Kampbell. 2006. Relationship between *Dehalococcoides* DNA in ground water and rates of reductive dechlorination at field scale. *Water Research*, Vol. 40:3131-3140.
- Magli, A., F.A. Rainey, and T. Leisinger. 1995. Acetogenesis from dichloromethane by a two-component mixed culture comprising a novel bacterium. *Applied Environmental Microbiology*, Vol. 61(8):2943-2949.
- Major, D.W., M.L. McMaster, E.E. Cox, E.A. Edwards, S.M. Dworatzek, E.R. Hendrickson, M.G. Starr, J.A. Payne, and L.W. Buonamici. 2002. Field demonstration of successful bioaugmentation to achieve dechlorination of tetrachloroethene to ethene. *Environmental Science & Technology*, Vol. 36(23):5106-5116.
- Major, D.W., E.H. Hodgins, and B.J. Butler. 1991. Field and laboratory evidence of in situ biotransformation of tetrachloroethene to ethene and ethane at a chemical transfer facility in North Toronto. In: *In Situ and On Site Bioreclamation*, R. Hincsee and R. Olfenbuttel (eds.). Butterworth-Heinemann, Stoneham, MA.

- Mann, H.B. and D.R. Whitney. 1947. On a test of whether one or more random variables is stochastically larger than in the other. *Annals of Mathematical Sciences*, Vol. 18:52-54.
- Maymo-Gatell, X., Y. Chien, J.M. Gossett, and S.H. Zinder. 1999. Reductive Dechlorination of Chlorinated Ethenes and 1,2-Dichloroethane by *Dehalococcoides ethenogenes* 195, *Applied and Environmental Microbiology*, Vol. 65:3108-3113.
- Maymo-Gatell, X., Y. Chien, J.M. Gossett, and S.H. Zinder. 1997. Isolation of a bacterium that reductively dechlorinates tetrachloroethene to ethene. *Science*, Vol. 276:1568-1571.
- McCarty, P.L., and Semprini, L. 1994. Groundwater Treatment for Chlorinated Solvents, Section 5. In: Norris, R.D., Hinchee, R.E., Brown, R., McCarty, P.L, Semprini, L., Wilson, J.T., Kampbell, D.H., Reinhard, M., Bouwer, E.J., Borden, R.C., Vogel, T.M., Thomas, J.M., and Ward, C.H., editors, *Handbook of Bioremediation*: Lewis Publishers, Boca Raton, Florida.
- Messmer, M, and T. Leisinger. 1997. Degradation of dichloromethane by *Dehalobacterium formicoaceticum*. Information on the internet page of the Institute for Microbiology at the Swiss Federal Institute of Technology in Zürich, Switzerland.
- Montgomery Watson Harza. 2003. *Draft Treatability Study Report, Enhanced Bioremediation Via Vegetable Oil Emulsion Injection, Landfill 1 (LF-08)*. Prepared for Whiteman AFB and the Air Force Center for Environmental Excellence. April.
- Morse, J.J., B.C. Alleman, J.M. Gossett, S.H. Zinder, D.E. Fennell, G.W. Sewell, and C.M. Vogel. 1998. *Draft Technical Protocol: A Treatability Test for Evaluating the Potential Applicability of the Reductive Anaerobic Biological In Situ Treatment Technology (RABITT) to Remediate Chloroethenes*. Prepared for ESTCP. February 1998.
- National Academy of Sciences. 2000. *Natural Attenuation for Groundwater Remediation*. Available at [www.nap.edu/openbook/0309069327/html/r1.html](http://www.nap.edu/openbook/0309069327/html/r1.html).
- Nelson, M.J.K, S. Montgomery, and P. Prichard. 1988. Trichloroethylene Metabolism by Microorganisms that Degrade Aromatic Compounds. *Applied and Environmental Microbiology*, Vol. 54(2):604-606.
- Newell, C.J., H.S. Rafai, J.T. Wilson, J.A. Connor, J.A. Aziz, and M.P. Suarez,. 2003. Calculation and use of first-order rate constants for monitored natural attenuation studies. *Ground Water Issue*. Cincinnati, OH: USEPA.
- Newman, W.A., and R.C. Pelle. 2006. Enhanced Anaerobic Bioremediation of Chlorinated Solvents Utilizing Vegetable Oil Emulsions. *Remediation*, Summer 2006, pp. 109-122.
- Noureddini, H., B.C. Teoh, and L.D. Clements. 1992a. Densities of vegetable-oils and fatty-acids. *Journal of the American Oil and Chemical Society*, Vol. 69:1184-1188.
- Noureddini, H., B.C. Teoh, and L.D. Clements. 1992b. Viscosities of vegetable-oils and fatty-acids *Journal of the American Oil and Chemical Society*, Vol. 69:1189-1191.
- Oldenhuis R., J.Y. Oedzes, J.J. van der Waarde, and D.B. Janssen. 1991. Kinetics of chlorinated hydrocarbon degradation by *Methylosinus trichorsporium* OB3b and toxicity of trichloroethylene. *Applied and Environmental Microbiology*, Vol. 57:7-14.

- Parsons Infrastructure & Technology Group, Inc. (Parsons). 2007. *Final Project Completion Report for an Enhanced Bioremediation Field Feasibility Test at North Lobe of the AOC-2 TCE Plume, Naval Air Station Fort Worth Joint Reserve Base, Texas*. Prepared for the Air Force Center for Engineering and the Environment, Brooks City-Base, Texas. June.
- Parsons. 2006a. *Final Project Completion Report for a Field Feasibility Test for In Situ Bioremediation of Chlorinated Solvents Via Vegetable Oil Injection at Site FTA-2, Tinker Air Force Base, Oklahoma*. Prepared for the Air Force Center for Environmental Excellence, Brooks City-Base, Texas. May.
- Parsons. 2006b. *Final Project Completion Report, Demonstration Study for Enhanced In Situ Bioremediation of Chlorinated Solvents at Site LF05 (Former Tri-Services Landfill), Hickam Air Force Base, Oahu, Hawaii*. Prepared for the Air Force Center for Environmental Excellence, Brooks City-Base, Texas. July.
- Parsons. 2004a. *Final Summary of Laboratory Microcosm Studies and Engineering Implications of Using Vegetable Oils to Stimulate Reductive Dechlorination of Chlorinated Solvents*. Prepared for the Strategic Environmental Research and Development Program. June.
- Parsons. 2004b. *Final Project Completion Report for a Field Feasibility Test for In Situ Bioremediation of Chlorinated Solvents Via Vegetable Oil Injection at Site SS015, Travis Air Force Base, California*. Prepared for the Air Force Center for Environmental Excellence, Brooks City-Base, Texas. July.
- Parsons. 2002a. *Final Phase II Field Feasibility Test for In Situ Bioremediation of Chlorinated Solvents Via Vegetable Oil Injection at Hanger K Area, Cape Canaveral Air Force Station, Florida*. Prepared for the Air Force Center for Environmental Excellence, San Antonio, Texas. March.
- Parsons. 2002b. *Technology Application for Enhanced In-Situ Bioremediation of Chlorinated Aliphatic Hydrocarbons via Organic Substrate Addition for Site FF-87, Former Newark AFB, Ohio*. Prepared for the Air Force Center for Environmental Excellence, San Antonio, Texas. January.
- Parsons. 2002c. *Final Field Feasibility Test for In-Situ Bioremediation of Chlorinated Solvents via Vegetable Oil Injection at Site N-6, Former Naval Support Activity Mid-South, Millington, Tennessee*. July. Denver, Colorado.
- Parsons 2002d. *Final Interim Report: Performance and Cost of Anaerobic Dechlorination, Phase I Site Survey*. Prepared for the Naval Facilities Engineering Service Center (NFESC), Port Hueneme, California and the Environmental Security Technology Certification Program, Arlington, Virginia. December.
- Parsons, F., P.R. Wood, and J. DeMarco. 1984. Transformations of tetrachloroethene and trichloroethene in microcosms and groundwater. *Journal American Water Works Association*. Vol.76:56-59.
- Parsons, F., G. Barrio-Lage, and R. Rice. 1985. Biotransformation of chlorinated organic solvents in static microcosms: *Environmental Toxicology and Chemistry* Vol. 4:739-742.



- Perlmutter, M.W., R. Britto, J.D. Cowan, M. Patel, and M. Craig. 2000. Innovative technology: In situ biotreatment of perchlorate-contaminated groundwater. In: *Air and Waste Management Association, 93rd Annual Conference and Exhibition*, Salt Lake City, Utah.
- Pfeiffer, P. 2003. *Abiotic Effects of Vegetable Oil Added to Enhance In-Situ Bioremediation of Chlorinated Solvents*. Masters of Science Thesis, University of Colorado, Boulder, CO.
- Pfeiffer, P.R., A.R. Bielefeldt, T. Illangasekare, and B. Henry. 2005. Partitioning of chlorinated ethenes into vegetable oil. *Water Research*, Vol. 39(18):4521-4527.
- Przybylski, R. 2004. *Canola Oil: Physical and Chemical Properties*, Canola Council of Canada, Winnipeg, MB, (<http://www.canola-council.org/pubs/Chemical1-6.pdf>)
- Ralston, A.W. and C.W. Hoerr. 1942. The solubilities of the normal saturated fatty acids. *Journal of Organic Chemistry*. Vol. 7(6):546-555.
- Raymond, R.L., Jr., M.D. Lee, R.J. Buchanan, and D.E. Ellis. 2003. Cost Implications of Hydrogen Donor Selection for In Situ Bioremediation of Chlorinated Solvents. Proceedings of the *Seventh International Symposium of In Situ and On-Site Bioremediation* (Orlando, Florida, June 2003). Paper A-37. Battelle Press, Columbus, Ohio.
- Remediation Technologies Development Forum (RTDF). 1997. Natural Attenuation of Chlorinated Solvents in Groundwater Seminar, Class Notes (Contacts: Dr. Leo Lehmicke, Beak Consultants, Seattle, Washington; Dr. Ron Buchanan, DuPont, Wilmington, Delaware).
- Richardson, R.E., V.K. Bhupathiraju, D.L. Song, T.A. Goulet, and L. Alvarez-Cohen. 2002. Phylogenetic characterization of microbial communities that reductively dechlorinate TCE based upon a combination of molecular techniques. *Environmental Science & Technology*. Vol. 36:2652-2662.
- Ritalahti, K.M. and F.E. Löffler. 2004. Populations Implicated in Anaerobic Reductive Dechlorination of 1,2-Dichloropropane in Highly Enriched Bacterial Communities. *Applied and Environmental Microbiology*, Vol. 70:4088-4095.
- Rodriguez, B.X. 2004. *Evaluation of Slow Release Substrates for Anaerobic Bioremediation*. Masters of Science in Civil Engineering, North Carolina State University, Raleigh, NC.
- Roland, I., G. Piel, L. Delattre, and B. Evrard. 2003. Systematic characterization of oil-in-water emulsions for formulation design. *International Journal of Pharmaceutics*, Vol. 263:85-94.
- Ryan, J.N. and M. Elimelech. 1996. Colloid mobilization and transport in groundwater: Colloids and Surfaces: *Annals of Physiochemistry & Engineering Asp.* 1-56.
- Sawyer, C.N., P.L. McCarty, and G.F. Parkin. 1994. *Chemistry for Environmental Engineering*. McGraw-Hill Inc.
- Schwille, F. 1998. *Dense Chlorinated Solvents in Porous and Fractured Media: Model Experiments* (English Translation), Lewis Publishers, Ann Arbor, Michigan.

- Sin Chit To. 2001. *Use of Vegetable Oil in Reductive Dechlorination of Tetrachloroethene*, Cornell University Masters Thesis, Ithaca, NY.
- Smatlak, C.R., J.M. Gossett and S.H. Zinder. 1996. Comparative kinetics of hydrogen utilization for reductive dechlorination of tetrachloroethene and methanogenesis in an anaerobic enrichment culture: *Environmental Science & Technology*, Vol. 30:2850-2858.
- Solutions IES, Inc. (Solutions IES) 2006. *Edible Oil Barriers for Treatment of Perchlorate Contaminated Groundwater*. Prepared for the Environmental Security Technology Certification Program. February 16, 2006.
- Solutions-IES. 2005. *Report of Groundwater Remediation Pilot Test Effectiveness for the Former Tarheel Army Missile Plant*. Prepared for the US Army Environmental Center, Aberdeen, MD. November.
- Solutions-IES and Terra Systems, Inc. (TSI). 2004. *Enhanced In Situ Reductive Dechlorination of Trichloroethene Using Edible Oil Emulsion, Altus Air Force Base*. Prepared for the Air Force Center for Environmental Excellence, Brooks City-Base, TX, September.
- Solutions-IES and TSI. 2005. *Enhanced In Situ Reductive Dechlorination of Trichloroethene Using Edible Oil Emulsion, Edwards Air Force Base*. Prepared for the Air Force Center for Environmental Excellence, Brooks City-Base, TX. February.
- Soo, H. and C.J. Radke. 1984. The flow mechanism of dilute stable emulsions in porous media. *Industrial Engineering Chemical Fundamentals*, Vol. 23:342-347.
- Soo, H. and C.J. Radke. 1986a. A filtration model for the flow of dilute stable emulsions in porous media – I. Parameter evaluation and estimation. *Chemical Engineering Science*, Vol. 41:273-281.
- Soo, H. and C.J. Radke. 1986b. A filtration model for the flow of dilute stable emulsions in porous media – I. Theory. *Chemical Engineering Science*, Vol. 41:263-272.
- Strand, S.E., and L. Shippert. 1986. Oxidation of chloroform in an aerobic soil exposed to natural gas. *Applied and Environmental Microbiology*, Vol. 52(1):203-205.
- Strategic Environmental Research and Development Program (SERDP) and Environmental Security Technology Certification Program (ESTCP). 2005. *SERDP and ESTCP Expert Panel Workshop on Research and Development Needs for the Environmental Remediation Application of Molecular Biological Tools*. October.
- Stromeyer S.A., K. Stumpf, A.M. Cook, and T. Leisinger. 1992. Anaerobic degradation of tetrachloromethane by *Acetobacterium woodii*: separation of dechlorinative activities in cell extracts and roles for vitamin B<sub>12</sub> and other factors. *Biodegradation*, Vol. 3:113-123.
- Stroo, H.F., A. Leeson, A.J. Shepard, S.S. Koenigsberg, and C.C. Casey. 2006. Environmental remediation applications of molecular biological tools. *Remediation*, Vol. 16:125-136.

- Sung, Y., K.M. Ritalahti, R.P. Apkarian, and F.E. Löffler. 2006. Quantitative PCR confirms Purity of Strain GT, a Novel Trichloroethene-to-Ethene-Respiring *Dehalococcoides* Isolate. *Applied and Environmental Microbiology*, Vol. 73(3): 1980-1987.
- Suthersan, S.S. 2001. *Natural and Enhanced Remediation Systems*. Lewis Publishers, Boca Raton, Florida. 440 p.
- Suthersan, S.S., C.C. Lutes, P.L. Palmer, F. Lenzo, F.C. Payne, D.S. Liles, and J. Burdick. 2002. *Final Technical Protocol for Using Soluble Carbohydrates to Enhance Reductive Dechlorination of Chlorinated Aliphatic Hydrocarbons, December 19, 2002*. Submitted to ESTCP and AFCEE under Contract #41624-99-C-8032.
- TSI and Solutions-IES. 2003. *Interim Report: Technology Application of Low Cost Emplacement of Insoluble Organic Substrate for Enhanced In Situ Reductive Dechlorination of Halogenated Aliphatic Hydrocarbons, Dover Air Force Base*. Prepared for the Air Force Center for Environmental Excellence, Brooks City-Base, TX. March.
- TSI and Solutions-IES. 2004. *Installation Report: Technology Application of Low Cost Emplacement of Slowly-Soluble Organic Substrate for Enhanced In Situ Reductive Dechlorination of Halogenated Aliphatic Hydrocarbons, Arnold Air Force Base*. Prepared for the Air Force Center for Environmental Excellence, Brooks City-Base, TX. June.
- Ullman, S.K. 2004. *Use of Emulsified Vegetable Oil for Remediation of DNAPL Sites: Experimental Evaluation of Emulsion Behavior and Characterization using Tracers*, Masters of Science, Colorado School of Mines, Golden, CO.
- United States Air Force (USAF). 2007. *Final Treatability Study for Enhanced Monitored Natural Attenuation at DP98, Elmendorf Air Force Base, Alaska*. Prepared by Parsons for AFCEE and Elmendorf AFB, Alaska. April.
- United States Environmental Protection Agency (USEPA). 1998. *Technical Protocol for Evaluating Natural Attenuation of Chlorinated Solvents in Groundwater*. Cincinnati, OH: National Risk Management Research Laboratory, Office of Research and Development, USEPA. EPA/600/R-98/128.
- USEPA. 2000. *Engineered Approaches to In Situ Bioremediation of Chlorinated Solvents: Fundamentals and Field Applications*. Office of Solid Waste and Emergency Response, Division of Solid Waste and Emergency Response. EPA 542-R-00-008. July. Available at <http://www.epa.gov/clu-in.org>.
- USEPA and the Remediation Technology Development Forum (RTDF). 1998. *Permeable Reactive Barrier Technologies for Contaminant Remediation*. USEPA Office of Research and Development, EPA/600/R-98/125. September 1998.
- Vannelli T., M. Logan, D.M. Arciero, and A. Hooper. 1990. Degradation of halogenated aliphatic compounds by ammonia-oxidizing bacterium *Nitrosomonas europaea*. *Applied and Environmental Microbiology*, Vol. 56:1169-1171.
- Vogel, T.M. and P.L. McCarty. 1987. Abiotic and biotic transformations of 1,1,1-trichloroethane under methanogenic conditions: *Environmental Science & Technology*, Vol. 21(12):1208-1213.

- Volkering, F. and C. Pijls. 2004. Factors Determining Reductive Dechlorination of *cis*-1,2-DCE at PCE Contaminated Sites. *Proceedings of the Fourth International Conference on Remediation of Chlorinated and Recalcitrant Compounds* (Monterey, CA; May 2004). Paper 3D-10. Columbus, OH: Battelle Press.
- Wackett, L.P., G.A. Brusseau, S.A. Householder, and R.S. Hanson. 1989. Survey of microbial oxygenases: trichloroethylene degradation by propane-oxidizing bacteria. *Applied and Environmental Microbiology*, Vol. 55:2960-2964.
- Walton, W.C. 1988. *Practical Aspects of Groundwater Modeling*. National Water Well Association, Worthington, Ohio, 587 p.
- Westall, J.C. and P.M. Gschwend. 1993. Mobilizing and Depositing Colloids. *Manipulation of Groundwater Colloids for Environmental Restoration*. Lewis Publishers, Ann Harbor, 1993.
- Wiedemeier, T.H., H.S. Rifai, C.J. Newell, and J.T. Wilson. 1999. *Natural Attenuation of Fuels and Chlorinated Solvents in the Subsurface*, John Wiley & Sons, New York, New York, p. 617
- Wild, A.P., W. Winkelbauer, and T. Leisinger. 1995. Anaerobic dechlorination of trichloroethene, tetrachloroethene, and 1,2-dichloroethane by an acetogenic mixed culture in a fixed-bed reactor. *Biodegradation*, Vol. 6(4):309-318.
- Wilkin, R.T. 2006. Mineralogical Preservation of Solid Samples Collected from Anoxic Subsurface Environments. *Groundwater Issue*, EPA/600/R-06/112. October.
- Wilkin, R.T., and K.J. Bischoff. 2006. Coulometric determination of total sulfur and reduced sulfur fractions in environmental samples. *Talanta*, Vol. 70:766-773.
- Wilson, J. T. and B. H. Wilson. 1985. Biotransformation of trichloroethylene in soil. *Applied and Environmental Microbiology*, Vol. 49:242-243.
- Wilson, J.T., H.S. Cho, and F.P. Beck. 1997. Field estimation of hydraulic conductivity for assessments of natural attenuation. In: *In Situ and On-Site Bioremediation*, Volume 2. Columbus: Battelle Press: pp 309-314.
- Yan, T., T.M. LaPara, P.J. Novak. 2006. The reductive dechlorination of 2,3,4,5-tetrachlorobiphenyl in three different sediment cultures: evidence for the involvement of phylogenetically similar *Dehalococcoides*-like bacterial populations. *FEMS Microbiology Ecology*, Vol. 55(2): 248-261.
- Yang, Y. and P.L. McCarty. 1998. Competition for Hydrogen within a Chlorinated Solvent Dehalogenating Anaerobic Mixed Culture. *Environmental Science & Technology*, Vol. 32(22):3591-3597.
- Zawtocki, C. 2005. Naturally cleaner groundwater – Soybean-based emulsion is proving to decontaminate groundwater more quickly than traditional remediation methods. *Military Engineer*, Vol. 97(637):55-56. Sept-Oct 2005.
- Zawtocki, C., M.T. Lieberman and G.M. Birk. 2004. A dash of oil and let marinate, *Pollution Engineering*, May 2004, pp. 30-34.

Zenker, M.J., R.C. Borden, M.A. Barlaz, M.T. Lieberman and M.D. Lee, M.D. 2000. Insoluble substrates for reductive dehalogenation in permeable reactive barriers, *In: G. Wickramanayake, A. Gavaskar, B. Alleman, and V. Magar, editors, Bioremediation and Phytoremediation of Chlorinated and Recalcitrant Compounds*, p. 47-53.

## **APPENDIX A: KEY PROJECT PERSONNEL**

**APPENDIX B**

**SUMMARY TABLE OF DOD EDIBLE OIL APPLICATIONS**

**Table B.1 Summary of DoD Edible Oil Applications for Chlorinated Solvents**

Site Name	Location	Scale	Start Date	Injection Summary	References/Notes
<b>Air Force Center for Environmental Excellence</b>					
Hangar K	Cape Canaveral Air Force Station, FL	Pilot Expanded	June 1999 July 2000	Single Well Neat Oil Injection Test Straight Oil Injection/Water Push	Appendix H; Parsons, 2002a
SS015	Travis AFB, CA	Pilot Expanded	April 2000 December 2000, April 2002	Straight Oil Injection/Water Push Straight Oil/Water Push and Emulsions. Injection Points and Direct Injection	Parsons, 2004b
Site FF-87	Former Newark AFB, OH	Full Expanded	September 2001 October 2003	Injection Points with Emulsion Direct Injection with Emulsion	Parsons, 2002b
Site LF-08	Whiteman AFB, MO	Pilot	July 2002	Direct Injection with Emulsion	Montgomery Watson Harza, 2003
WP-21	Dover AFB, DE	Pilot Expanded	April 2000 August 2003	Straight Oil/Water Push into Injection Points; Injection Points with Emulsion	TSI and Solutions-IES, 2003
Site 14	Edwards AFB, CA	Pilot	September 2000	Injection Points with Emulsion	Solutions-IES and TSI, 2005
Site 162	Edwards AFB, CA	Pilot	December 2005	Injection Points with Emulsion	
SS-17 and OU-1	Altus AFB, OK	Pilot	December 2001 December 2001	Injection Points with Emulsion Single Injection with Emulsion	Solutions-IES and TSI, 2004
SWMU 10	Arnold AFB, TN	Pilot	December 2003	Straight Injection into DNAPL Zone Injection Points with Emulsion	TSI and Solutions-IES, 2004
AOC-2	NAS Fort Worth, TX	Pilot	July 2003	Injection Points with Emulsion	Parsons, 2007
LF-05	Hickam AFB, HI	Pilot	April 2003	Injection Points with Emulsion into DNAPL Source Area	Parsons, 2006b
FTA-2	Tinker AFB, OK	Pilot	October 2003	Injection Points with Emulsion	Parsons, 2006a
IC-42	Former McClellan AFB, CA	Pilot	2004	Emulsion injected into two test cells, one cell bioaugmented	
DP98	Elmendorf AFB, AK	Pilot	July 2005	Permanent injection wells with emulsion and sodium lactate	USAF, 2007
Kenney Plume	Elmendorf AFB, AK	Pilot	August 2006	Permanent injection wells with emulsion and sodium lactate	
SWMU-16	Keesler AFB, MS	Full-scale	August 2005	Injection Points with Emulsion	
SS-041 and SS-042	Rickenbacker AFB, OH	Full-scale	November 2005	Injection points with emulsion; vegetable oil sprayed on excavation backfill	
S-1, R-2, and C-7	Former Gentile AFB, OH	Full-scale	October 2005	Injection points with emulsion	

(continued)



**Table B.1 Summary of DoD Edible Oil Applications for Chlorinated Solvents (continued)**

Site Name	Location	Scale	Start Date	Injection Summary	References/Notes
<b>Air Force Center for Environmental Excellence (continued)</b>					
Arrow Street TCE Plume	Former Wurtsmith AFB, MI	Pilot	September 2005	Single injection point with injection of 10,000 gallons of dilute emulsion.	
<b>Naval Facilities Engineering Command</b>					
Site N-6	NSA Mid-South, TN	Pilot	August 2000	Neat Oil Injection with Water Push	Parsons, 2002c
Anoka County Park	NIROP Fridley, MN	Pilot	November 2001	Injection Points with Emulsion	
Site 17	Naval Weapons Station, Charleston, SC	Pilot	May 2004	Injection Points with Emulsion	
Site 13	NAB Little Creek, VA	Full-Scale	December 2004	Injection Points with Emulsion	
Areas S, M, and F	NWIRP McGregor, TX	Pilot to Full-Scale	1999 to Present	For treatment of perchlorate and chlorinated solvents Oil coated woodchips in biowall trenches. Biowalls recharged by injection of microemulsion through dedicated injection ports in biowall trenches.	Cowan <i>et al.</i> , 2000; Perlmutter <i>et al.</i> , 2000
Site 11	Naval Submarine Base Kings Bay, GA	Full-Scale	December 2001	Injection Points with Emulsion	
Site 4	NSWC White Oaks, MA	Full-Scale	October 2006	Injection Points with Emulsion	
	Naval Training Center Orlando, FL	Full-Scale	2004	Injection Points with Emulsion	
Site 36	Naval Training Center Orlando, FL	Full-Scale	December 2000	Direct Injection of Neat Oil	
Site 39	Naval Training Center Orlando, FL	Full-Scale	January 2001	Direct Injection of Neat Oil	
SA 17	Naval Training Center Orlando, FL	Full-Scale	July 2006	Temporary Recirculation of Emulsion	
OU4	Naval Training Center Orlando, FL	Full-Scale	October 2006 (planned)	Direct Injection of Emulsion	
OU2	Naval Training Center Orlando, FL	Full-Scale	November 2006 (planned)	Direct Injection of Emulsion	

(continued)

**Table B.1 Summary of DoD Edible Oil Applications for Chlorinated Solvents (concluded)**

<b>Site Name</b>	<b>Location</b>	<b>Scale</b>	<b>Start Date</b>	<b>Injection Summary</b>	<b>References/Notes</b>
<b>Other DoD Sites</b>					
Waste Accumulation Pad	Tarheel Army Missile Plant, NC	Pilot	July 2004	Temporary Recirculation of Emulsion through Source Area	Solutions-IES, 2005
IRP Site 2	Air National Guard Base, VT	Pilot	June 2002	Injection Points with Emulsion	
BRAC-51	Defense Depot Hill Utah, UT	Full-Scale	May 2000	Backfill Source Area Excavation	
OU-2	Defense Depot Hill Utah, UT	Pilot	July 1999 July 2000	Single Well Push-Pull Injection Points with Emulsion	
Landfill B3	Camp Stanley, TX	Pilot	October 2006	Injection Well with Emulsion	

**APPENDIX C**  
**VENDOR LIST OF EDIBLE OIL PRODUCTS**

## APPENDIX C VENDOR LIST OF EDIBLE OIL PRODUCTS

EOS Remediation Products, Inc.

Product: EOS<sup>®</sup>-598

Contact: Gary Birk

1101 Nowell Road

Raleigh, NC 27607

Ph: (919) 873-2204

Fax: (919) 873-1074

(www.eosremediation.com)

Remediation and Natural Attenuation Services, Inc.

Product: Newmans Zone<sup>®</sup>

Contact: Bill Newman

PO Box 290068

Brooklyn Center, MN 55429

ph: (763) 585-6191

fax: (763) 585-6195

(www.rnasinc.com)

Terra Systems, Inc.

Product: Slow Release Substrate<sup>™</sup> (SRS<sup>™</sup>)

Contact: Dick Raymond

1035 Philadelphia Pike

Wilmington, DE 19809

ph: (302) 798-9553

fax: (302) 798-9554

(www.terrasystems.net)

The Solae Company

Product: Textrol-BR<sup>®</sup>

Contact: Richard Hilts

5529 Quail Canyon Drive

Fort Wayne, IN 46835

ph: (260) 486-1674

fax: (260) 486-8708

(www.solae.com)

DBI Remediation Products, LLC

Product: CAP-18<sup>®</sup>

Contact: Steve Irvin

10420 Hague Road, Suite D

Fishers, IN 46038

ph: (317) 576-1998

fax: (317) 570-4943

(www.dbiproducts.com)

Regenesis Bioremediation Products

Product: HRC Advanced<sup>®</sup>

Contact: Scott Wilson

1011 Calle Sombra

San Clemente, CA 92673

ph: (949) 366-8000

fax: (949) 366-8090

(www.regenesis.com)

Redox Tech, LLC

Product: Anaerobic Biochem ABC<sup>®</sup>

Contact: John Haselow

1006A Morrisville Parkway

Morrisville, NC 27560

ph: (919) 460-0330

fax: (919) 460-0211

(www.redox-tech.com)

## **APPENDIX D**

### **PROPERTIES AND BEHAVIOR OF EDIBLE OIL**

## **APPENDIX D**

### **PROPERTIES AND BEHAVIOR OF EDIBLE OIL AND EDIBLE OIL EMULSIONS**

Research and field experience has shown that chlorinated solvents can be treated through injection of edible oil as either pure (neat) oil or as an oil-in-water emulsion (*e.g.*, see case studies in [Appendix H](#)). The injection of edible oil may initially reduce aqueous concentrations due to partitioning (sorption) into residual oil. The edible oil is also fermented to molecular hydrogen (H<sub>2</sub>) and low-molecular weight fatty acids, providing carbon and energy for reductive dechlorination ([Appendix E](#)). These processes are a result, in large part, of the physical and chemical properties of edible oil.

This appendix presents background information on the physical and chemical properties of edible oil, the effect of edible oil on the transport and fate of chlorinated solvents, and the distribution of edible oil and edible oil emulsions when injected into the subsurface. The data is presented as follows:

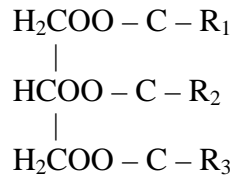
- [Section D.1](#) describes the physical and chemical properties of edible oil and edible oil emulsions.
- [Section D.2](#) describes the effect of residual oil on partitioning of contaminants between the aqueous, nonaqueous phase oil, and solid phases; and the impact of that partitioning on aqueous concentrations and contaminant migration.
- [Section D.3](#) presents information on the biological degradation of edible oil, including selection of edible oil type, fermentation of these oils to hydrogen and acetate, and the stimulation of reductive dechlorination processes.
- [Section D.4](#) describes the distribution of edible oil and edible oil emulsions when injected into the subsurface, including impacts on hydraulic conductivity.

This information is intended to supplement [Section 4](#) and [Section 5](#) of this protocol document, which provide step-by-step guidance for design and implementation of edible oil applications.

#### **D.1 CHEMICAL AND PHYSICAL COMPOSITION OF EDIBLE OIL**

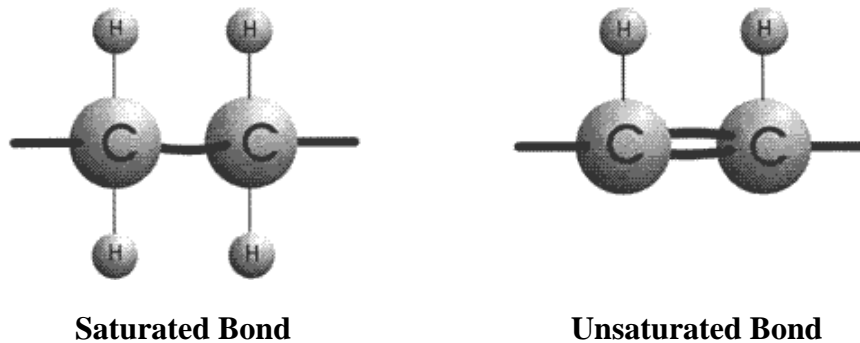
All animal and vegetable fats and oils are classified as triglycerides and contain three long chain fatty acids attached (esterified) to a glycerol core. When all of the fatty acids in a triglyceride are identical, it is termed a "simple" triglyceride. The more common forms, however, are "mixed" triglycerides which contain two or three different fatty acids.

The molecular structure of a typical mixed triglyceride is shown below.



R<sub>1</sub>, R<sub>2</sub> and R<sub>3</sub> represent different long-chain fatty acids. Typically, 100 grams of fat or oil will yield about 95 grams of fatty acids. The physical and chemical characteristics of the fatty acids have a major influence of the properties of the resulting fat or oil.

The predominant fatty acids present in animal and vegetable fats and oils contain 16 or 18 carbon atoms arranged in a chain. Fatty acids containing only single carbon-to-carbon bonds are termed "saturated" while fatty acids containing one or more carbon-to-carbon double bonds are termed "unsaturated." Saturated and unsaturated linkages are illustrated in **Figure D.1**.



**Figure D.1** Single ‘Saturated’ and Double ‘Unsaturated’ Carbon-Carbon Bonds (Institute of Shortening and Edible Oils [ISEO], 1999)

When the fatty acid contains one double bond it is called "monounsaturated." If it contains more than one double bond, it is called "polyunsaturated." Properties of common saturated and unsaturated fatty acids in food oil are presented in **Table D.1**. The melting point of saturated fatty acids increases with chain length. Unsaturated fatty acids often have lower melting points than the corresponding saturated fatty acid. The primary fatty acids present in vegetable oil are lauric, palmitic, stearic, oleic and linoleic. However, different oils contain different proportions of these fatty acids (**Table D.2**).

The physical properties of the different fats and oils will have a significant influence on their transport and distribution in the subsurface. Triglycerides are classified as ‘fats’ if they are solid at room temperature and ‘oil’ if they are liquid at room temperature. The following subsections describe the physical properties of pure edible oils and of edible oil emulsions.



**Table D.1**  
**Common Saturated and Unsaturated Fatty Acids**

<b>Systematic Name</b>	<b>Common Name</b>	<b>No. of Carbon Atoms</b>	<b>No. of Double Bonds</b>	<b>Melting Point °C</b>	<b>Typical Fat Source</b>
Ethanoic	Acetic	2	0	--	--
Butanoic	Butyric	4	0	-7.9	Butterfat
Hexanoic	Caproic	6	0	-3.4	Butterfat
Octanoic	Caprylic	8	0	16.7	Coconut oil
Decanoic	Capric	10	0	31.6	Coconut oil
9-Decenoic	Caproleic	10	1	-	Butterfat
Dodecanoic	Lauric	12	0	44.2	Coconut oil
9-Dodecenoic	Lauroleic	12	1	-	Butterfat
Tetradecanoic	Myristic	14	0	54.4	Butterfat, coconut oil
9-Tetradecenoic	Myristoleic	14	1	18.5	Butterfat
Hexadecanoic	Palmitic	16	0	62.9	Most fats and oils
9-Hexadecenoic	Palmitoleic	16	1	-	Some fish oils, beef fat
Octadecanoic	Stearic	18	0	69.6	Most fats and oils
9-Octadecenoic	Oleic	18	1	16.3	Most fats and oils
9-Octadecenoic	Elaidic	18	1	43.7	Partially hydrogenated oils
11-Octadecenoic	Vaccenic	18	1	44	Butterfat
9,12-Octadecadienoic	Linoleic	18	2	-6.5	Most vegetable oils
9,12,15-Octadecatrienoic	Linolenic	18	3	-12.8	Soybean oil, canola oil
Eicosanoic	Arachidic	20	0	75.4	Peanut oil
9-Eicosenoic	Gadoleic	20	1	-	Some fish oils
5,8,11,14-Eicosatetraenoic	Arachidonic	20	4	-49.5	Lard
5,8,11,14,17-Eicosapentaenoic	-	20	5	-	Some fish oils
Docosanoic	Behenic	22	0	80	Peanut oil
13-Docosenoic	Erucic	22	1	33.4	Rapeseed oil
4,7,10,13,16,19-Docosahexaenoic	-	22	6	-	Some fish oils

Source: ISEO, 1999.

**Table D.2**  
**Percent Fatty Acid Compositions for Major Edible Oils**  
(values in mole fraction of fatty acids as a percent)

Fatty Acid	Soy <sup>1</sup>	Corn <sup>1</sup>	Cotton-seed <sup>1</sup>	Palm <sup>1</sup>	Pea-nut <sup>1</sup>	Olive <sup>1</sup>	Canola <sup>2</sup>	Low Linolenic Canola <sup>2</sup>	High Oleic Canola <sup>2</sup>	Butter-fat <sup>1</sup>	Lard <sup>1</sup>	Beef Tallow <sup>1</sup>
C-4:0, Butyric										4		
C-6:0, Caproic										2		
C-8:0, Caprylic										1		
C-10:0, Capric										3		
C-12:0, Lauric										3		
C-14:0, Myristic			1	1			0.1	0.1	0.1	11	2	3
C-16:0, Palmitic	11	11	22	45	11	13	3.5	3.9	3.4	27	26	24
C-18:0, Stearic	4	2	3	4	2	3	1.5	1.2	2.5	12	14	19
C-20:0, Arachidic					1	1	0.6	0.6	0.9			
C-16:1, Palmitoleic			1			1	0.2	0.2	0.2	2	2	4
C-18:1, Oleic	24	28	19	40	48	71	60.1	61.1	76.8	29	44	43
C-20:1, Gadoleic					2		1.4	1.5	1.6		1	
C18:2, Linoleic	54	58	53	10	32	10	20.1	27.1	7.8	2	10	3
C-18:3, Linolenic	7	1	1			1	9.6	2.1	2.6	1		1
Other					4		2.9	2.2	4.1	3	1	3

Sources: <sup>1</sup> ISEO, 1999. <sup>2</sup> Przybylski, 2004.

## D.1.1 Properties of Pure Edible Oil

### D.1.1.1 Water Solubility and Interfacial Tension

Edible oil is commonly described as being ‘insoluble’ in water. However, all materials have at least some limited aqueous solubility. Unfortunately, very little published information is available on the aqueous solubility of common edible oils. In laboratory studies conducted at 25 degrees Celsius (°C), the aqueous solubility of soybean oil and corn oil were found to be 4.2 mg/L and 2.6 mg/L, respectively (Pfeiffer, 2003; Pfeiffer *et al.*, 2005). ***However, biological activity can greatly enhance the rate of carbon release from residual oil.*** Long (2004) found that live soil columns treated with emulsified soybean oil released between 50 and 100 mg/L dissolved organic and inorganic carbon.

The physical properties of edible oil are directly related to the properties of the fatty acids that they contain. **Table D.3** lists the aqueous solubility of the long-chain saturated fatty acids. Aqueous solubility increases with increasing temperature and decreases with increasing chain length. While edible oil solubility cannot be directly estimated from the fatty acid solubility, one can expect that oil containing predominantly long-chain fatty acids will be less soluble than oil containing shorter chain length fats and that oils will be somewhat less soluble at lower temperatures.

**Table D.3**  
**Aqueous Solubility of Common Saturated Fatty Acids at Different Temperatures**

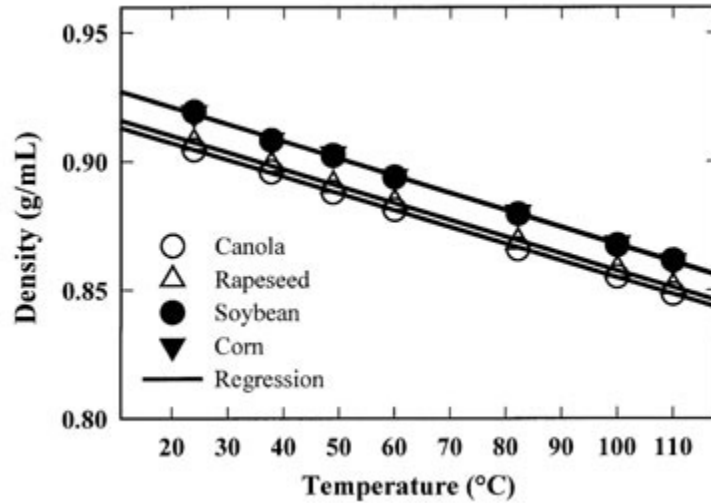
Common Name	No. of Carbon Atoms	Aqueous Solubility (mg/L)				
		0 °C	20 °C	30 °C	45 °C	60 °C
Caproic	6	8,640	9,680	10,190	10,950	11,710
Caprylic	8	440	680	790	950	1130
Capric	10	95	150	180	230	270
Lauric	12	37	55	63	75	87
Myristic	14	13	20	24	29	34
Palmitic	16	4.6	7.2	8.3	10	12
Stearic	18	1.8	2.9	3.4	4.2	5.0

Source: Ralston and Hoerr, 1942.

Only a few studies have been conducted on the surface tension and interfacial tension (against water) of edible oil and fatty acids. The surface tension of edible oil increases with an increase in fatty acid chain length and decreases with increasing temperature. The surface tension of cottonseed oil at 20 °C is 35.4 dynes/cm. The interfacial tension of soybean oil and cottonseed oil against water at 70 °C are both about 30 dynes/cm. At 20 °C, oleic acid has a surface tension of 32.5 dynes/cm and an interfacial tension against water of 15.6 dynes/cm. Surface tension and interfacial tension of edible oil can be lowered by the addition of different surfactants including lecithin, mono and diglycerides, free fatty acids, and traditional soaps.

### D.1.1.2 Density

All edible oils are less dense than water with a density at 15 °C typically varying between 0.91–0.93 grams per milliliter (g/mL). Density is temperature dependent and decreases in value when temperature increases (**Figure D.2**).



**Figure D.2** Effect of Temperature on Density of Selected Oils (Source: Przybylski (2004) adapted from Lang *et al.* (1992) and Nouredini *et al.* (1992a))

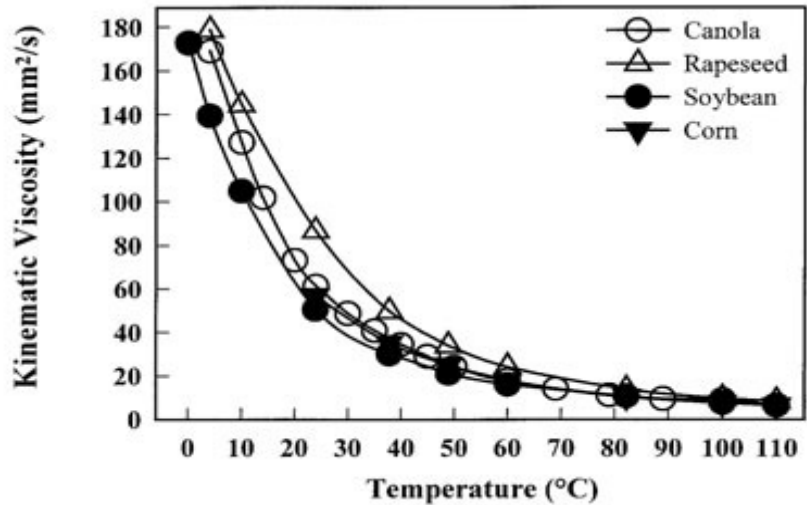
### D.1.1.3 Viscosity

All edible oils are more viscous than water which increases their resistance to flow. **Figure D.3** shows the effect of temperature on the viscosity of selected oils. For comparison, the kinematic viscosity of water is 1.3 milliliters squared per second ( $\text{mm}^2/\text{s}$  or centistokes) at 10 °C and 0.85 centistokes at 80 °C.

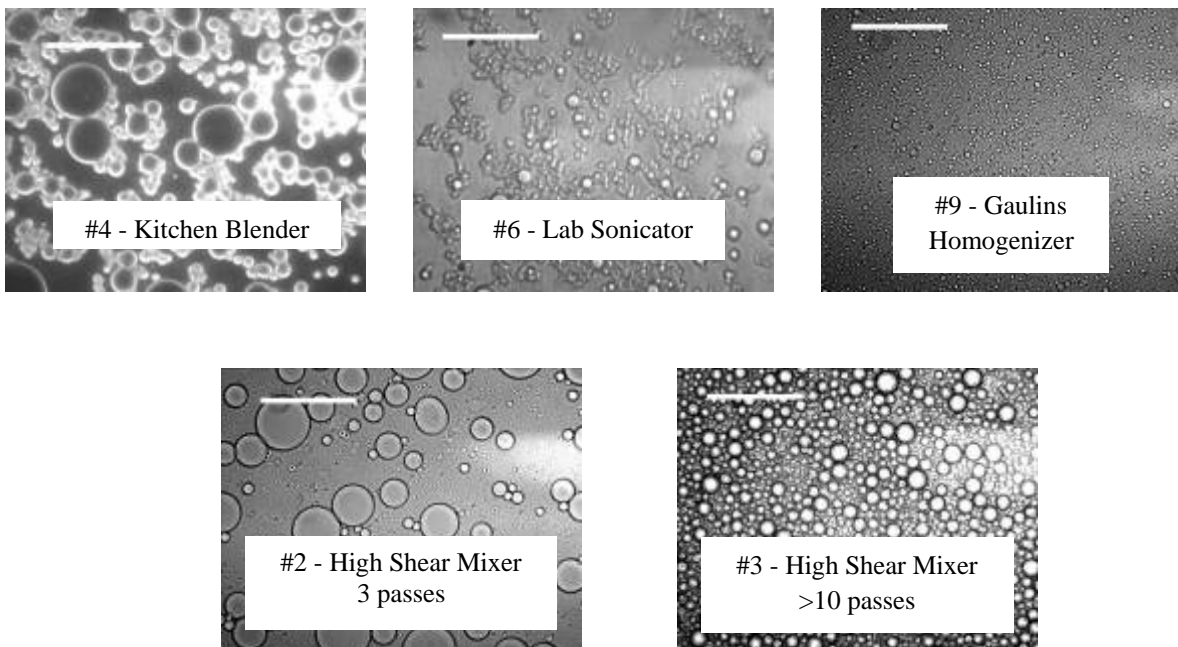
## D.1.2 Properties of Oil-in-Water Emulsions

### D.1.2.1 Emulsion Preparation

The food preparation industry has tremendous experience producing stable oil-in-water emulsions with a uniformly small droplet size (Becher, 2001). The primary objective in developing an emulsion formulation is to generate an emulsion with small, uniform droplets that do not flocculate. The key factors in generating the desired emulsion are 1) the oil-water interfacial tension, and 2) the mixing energy. Ideally, the emulsion mixture would be designed to match the site-specific conditions of the aquifer. Coulibaly and Borden (2004) evaluated several different combinations of surfactants and mixers to develop a procedure for generating stable emulsions with small, uniformly-sized oil droplets. Photomicrographs of several of the emulsions are shown in **Figure D.4**.



**Figure D.3 Effect of Temperature on Viscosity of Selected Oils** (Source: Przybylski (2004) adapted from Lang *et al.* (1992) and Nouredini *et al.* (1992b))



**Figure D.4 Emulsion Droplets Produced with Different Surfactants and Mixing Devices** (as described in Table D.4, white scale bar is 25  $\mu\text{m}$ )

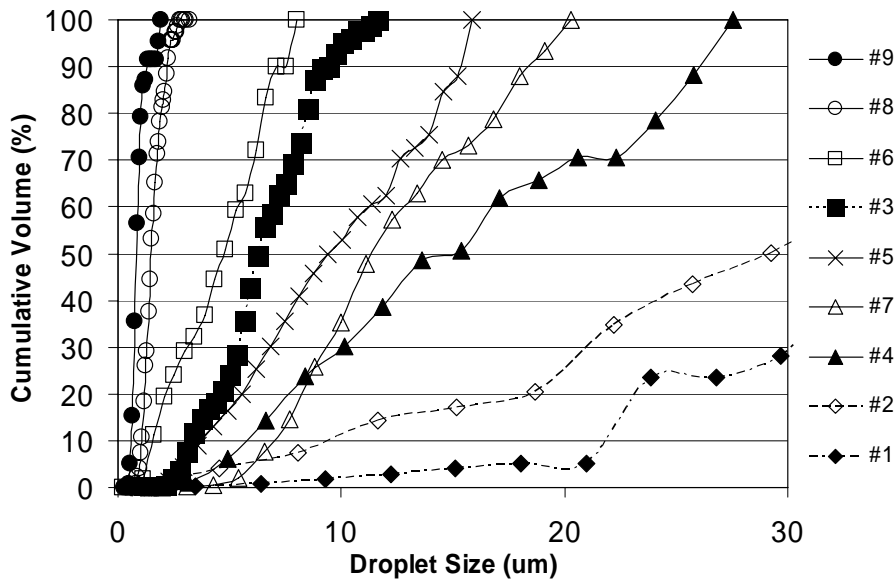
Most of the oil droplet size distributions are strongly non-symmetric with many small droplets and a few large droplets. However, the few large droplets contain a substantial portion of the total oil since the droplet volume is proportional to the diameter cubed. To provide a more useful presentation of these results, a statistical summary of the  $\text{Log}_{10}$

transformed droplet size distribution is presented in [Table D.4](#). The cumulative oil volume vs. droplet diameter for the different mixers is presented in [Figure D.5](#).

**Table D.4**  
**Characteristics of Droplet Size Distributions from Different Surfactant–Mixer Combinations**

#	Surfactant	Mixer	Mixing time	Median (µm)	Mean (µm)	Standard Deviation (µm)	Skewness of Log Dia.
1	Centrophase C lecithin	Kitchen blender on high speed	5 min.	2.7	3.9	3.1	0.7
2	Centrophase C lecithin	Silverson high shear mixer	3 passes	2.4	3.0	2.2	1.2
3	Centrophase C lecithin	Silverson high shear mixer	10 passes	3.2	3.6	1.5	0.5
4	Polysorbate 85	Kitchen blender on high speed	5 min.	4.6	4.8	1.7	0.4
5	Polysorbate 85	Lab. Homogenizer	5 min.	3.2	3.4	1.7	0.7
6	Polysorbate 85	Lab. Sonicator	5 min.	1.4	1.5	1.6	0.6
7	Polysorbate 80-GMO	Waring blender on low speed	3 min.	7.4	7.2	1.6	-0.3
8	Polysorbate 80-GMO	Waring blender on high speed	5 min.	1.2	1.2	1.3	0.2
9	Polysorbate 80-GMO	Gaulins homogenizer	1 pass	0.7	0.7	1.3	-0.3

Note: µm = Droplet diameter in micrometers. Statistics are for Log<sub>10</sub> transformed distribution of the oil droplet diameter.



**Figure D.5** Cumulative Droplet Volume Distributions for Different Emulsion Preparation Methods (emulsion numbers and preparation methods are listed in Table D.4)

The modified lecithin (Centrophase C from Central Soya, Inc., now Solae, LLC) resulted in coarse emulsion with a large average droplet size and wide range of droplets. In contrast, the polysorbate 85 and polysorbate 80 – glycerol monooleate (GMO) mixtures generated droplet size distributions with smaller, more uniform droplets. However, testing of different differing lecithin products for oil-in-water emulsions by Central Soya, Inc. indicated a lecithin product with a high hydrophile/lipophile balance (HLB) is required to create a stable emulsion. The Centrophase C lecithin product (HLB <8) used by Coulibaly and Borden (2004) is not the most desirable product for this purpose. Centromix E (HLB of 12) from Central Soya, Inc. is a much more suitable product and has been used commercially a soybean oil product designed for emulsification (Textrol-BR<sup>®</sup>) from the Solae Company in ionic emulsion formulations from RNAS, Inc.

A single pass through the Silverson mixer generated a very coarse emulsion that separated rapidly (data not shown). However, over 10 passes through the Silverson laboratory mixer (equivalent to > 4 passes through a full-size mixer) generated a good emulsion that was stable with small, uniform droplets.

The Gaulins homogenizer and the Waring commercial blender at high speed for 5 minutes provided the smallest, most uniform droplets. Emulsions prepared with polysorbate 80 - GMO and both the Silverson high shear mixer and dairy homogenizer were stable for at least one month when stored at 4 °C. Droplet size distributions from both mixers were measured immediately after preparation, after storage for one week and after storage for one month. For both mixers, there was no significant change in the droplet size distribution (data not shown).

A variety of different methods have been used to prepare emulsions for use in pilot and full-scale applications of the edible oil process at US Air Force bases. Formulas used for emulsion preparation in AFCEE supported projects are summarized in [Table D.5](#). Lecithin was used as the primary emulsifying agent in early AFCEE-supported projects. Later projects also used mixtures of polysorbate 80 and GMO as emulsifying agents along with sodium lactate and yeast extract as bacterial nutrients.

Emulsions can be prepared in the field through a four-step process: (1) dissolve all water soluble reagents in water; (2) dissolve all oil soluble reagents in oil; (3) blend oil and water together using an appropriate mixer; and (4) inject emulsion into the subsurface. Approaches used to mix the oil and water in the field include: (1) multiple passes through a static in-line mixer; (2) repeated pumping through a high-speed centrifugal pump; (3) a single pass through a high shear mixer (*e.g.*, Silverson Model 150/250 MS, East Longmeadow, Massachusetts); and (4) multiple passes through a high shear mixer.

Mixing with a static in-line mixer or a centrifugal pump is much simpler to implement in the field, but generates a coarse emulsion with relatively large oil droplets (5 to 30 microns). Use of the high shear mixer generates an emulsion with smaller, more uniformly size oil droplets. However, the high shear mixers are large pieces of equipment that can be cumbersome to use in the field. Use of emulsions with small oil droplets is preferred because these emulsions are easier to distribute in most aquifers with less permeability loss and associated pressure build up.

**Table D.5**  
**Formulas Used to Prepare Emulsion at Air Force Base Test Sites**

Air Force Base	Newark (Phase I)	Newark (Phase II)	Tinker	Forth Worth JRB	Dover	Edwards	Altus	Arnold
<b>Date of Application</b>	October 2001	October 2003	October 2003	August 2003	April 2000	September 2000	December 2001	December 2003
<b>Site</b>	FF-87	FF-87	FTA-2	AOC-2	WP-21	Site 14	SS-17	SWMU 10
<b>Water %</b>	74-75 %	91.3 %	93.1 %	88.8 %	96-97 %	81-86 %	70-76%	77%
<b>Soybean Oil %</b>	22-23 %	7.8 %	6.2 %	10.1 %	3 %	12-15 %	20-25 %	20%
<b>Soybean Oil Supplier</b>	Central Soya <sup>a</sup>	Central Soya <sup>a</sup>	Central Soya <sup>a</sup>	Central Soya <sup>a</sup>	Central Soya <sup>a</sup>	Cargill <sup>b</sup>	Lambent <sup>c</sup>	Lambent <sup>c</sup>
<b>Surfactant Type</b>	Lecithin Mix <sup>d</sup>	Lecithin Mix <sup>d</sup>	Lecithin Mix <sup>d</sup>	Lecithin Mix <sup>d</sup>	Lecithin Mix <sup>e</sup>	Lecithin Mix <sup>e</sup>	GMO & PS 80 <sup>f</sup>	GMO & PS 80 <sup>f</sup>
<b>Surfactant %</b>	2-3 %	0.9 %	0.7 %	1.1 %	0.2 %	2-4 %	4-5%	2%
<b>Additives</b>	none	none	Fructose (~12 grams per liter)	Fructose (~5 grams per liter)	none	none	Yeast Extract <sup>g</sup> ; Sodium lactate <sup>h</sup> ; Calcium chloride <sup>j</sup>	Yeast Extract <sup>g</sup> ; Sodium lactate (0.3%) <sup>i</sup> ; Sodium bicarbonate <sup>k</sup>
<b>Other</b>	Post-injection water push	none	Both pre-emulsion and post-emulsion water push	Both pre-emulsion and post-emulsion water push	Post emulsion water push	Pre-condition with lecithin; post-emulsion water push	Post-emulsion water push	Post-emulsion water push

a. Central Soya Corporation, Fort Wayne, IN (now: Solae Company)

b. *Centrapour Salad Oil*, Cargill Inc., Cedar Rapids, IA

c. *Oleocal IVO-114*, Lambent Technologies Corporation, Skokie, IL

d. *Centromix E*, Central Soya Corporation, Fort Wayne, IN (now: *Solae E*, Solae Company)

e. *Centolene A*, Central Soya Corporation, Fort Wayne, IN (now: Solae Company)

f. *Glycerol monooleate & polysorbate 80 premix*, Lambent Technologies Corporation, Skokie, IL

g. *Gistex LS Ferm Powder*, DSM Food Specialties, Egleville, PA

h. *Wilclear (60%)*, obtained from J.R.W. Technologies, Lenexa, KS

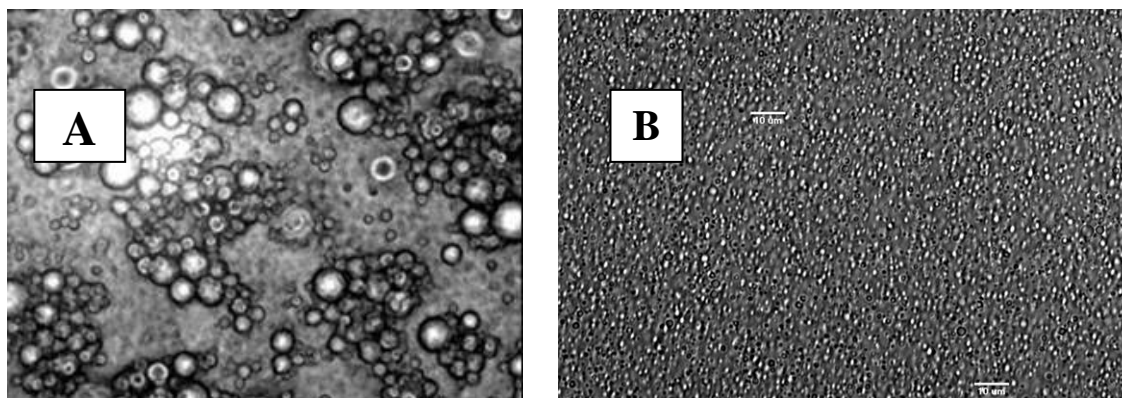
i. *Envirovac 60*, obtained from Purac America, S. Plainfield, NJ

k. *Sodium bicarbonate*, Coyne Chemicals, PA

j. *Calcium chloride (technical grade)*, Cole Parmer, Vernon Hills, IL.



An alternative to on-site emulsion preparation is to use pre-mixed commercial emulsion (see [Appendix C](#) for a list of vendors). Typically, a pre-mixed emulsion is provided as a concentrate and then diluted in the field using an on-site source of water (preferably groundwater). Pre-mixed emulsions are prepared under higher quality control conditions resulting in a more precise mix of the emulsion ingredients and a more controlled droplet size. [Figure D.6](#) shows the difference in droplet size between an emulsion prepared in the field and a pre-mixed emulsion. Pre-mixed emulsions are easier to handle in the field, require less equipment, and the amount of labor associated with preparation and injection is reduced. Some emulsion suppliers also include more easily degradable soluble substrates and nutrients (*e.g.*, lactate and yeast extract) to stimulate rapid initial growth of dechlorinating microorganisms. However, pound for pound the materials cost for purchase of the pre-mixed emulsions is higher than the cost to purchase the raw materials used to prepare the emulsions.



**Figure D.6 Photomicrographs of Emulsions: (a) Produced in the Field with a High Shear Mixer and (b) A Pre-mixed Emulsion (white scale bar is 10  $\mu$ m)**

#### **D.1.2.2 Emulsion Solubility and Interfacial Tension**

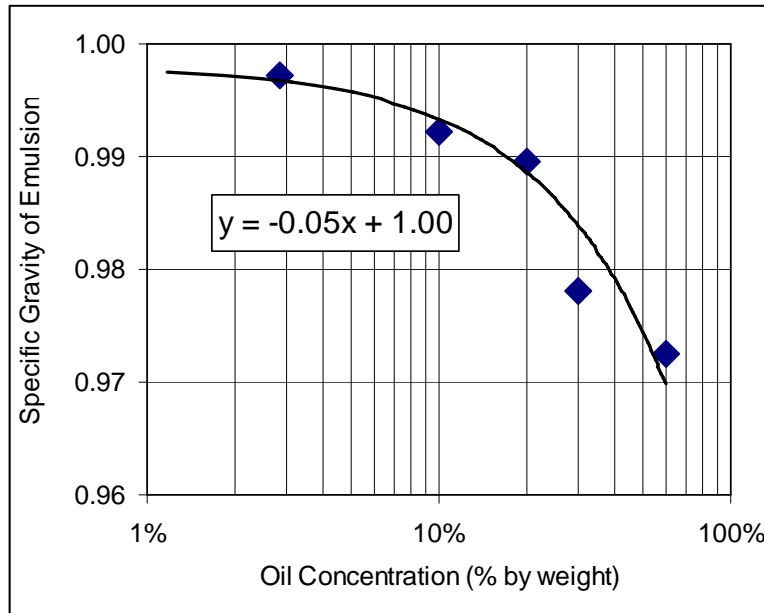
Oil-in-water emulsions are very easy to disperse in water because the individual emulsion droplets are already suspended in the water phase. For example, cream (an oil-in-water emulsion) is very easy to disperse in coffee. Technically, the emulsion does not ‘dissolve’ since the individual oil droplets remain suspended in the aqueous phase. Similarly, the interfacial tension between water and an oil-in-water emulsion is zero since water is the continuous phase for both materials.

Emulsifying an edible oil does not change the inherent water solubility of the oil used to prepare the emulsions. However, breaking the oil up into many small droplets does increase the oil-water interfacial area for dissolution and access by microorganisms.

#### **D.1.2.3 Density of Edible Oil Emulsions**

The density of concentrated oil emulsions is between 0.96 and 1.00 g/ml and varies as a function of oil content. [Figure D.7](#) shows the specific gravity of a commercially available emulsion (60% by weight soybean oil) when diluted in varying amounts of water. The manufacturers typically recommend that this material be diluted 20:1 to 4:1 with water prior to injection (3 to 12% final oil concentration), so the injected emulsion will have a specific

gravity (ratio of emulsion density to water) between 0.994 and 0.999. Given the small difference in density between the diluted emulsion and water, buoyancy effects are not expected to be significant. These density effects can be further reduced by adding dissolved solutes (salts or sodium lactate) to increase the emulsion density.



**Figure D.7 Specific Gravity of EOS 598B Emulsion Diluted with Varying Amounts of Water** (data provided courtesy of EOS Remediation, Inc.)

#### D.1.2.4 Viscosity

The viscosity of oil-in-water emulsions varies as a function of droplet size and oil content. **Table D.6** shows the effect of median oil droplet size on viscosity (Roland *et al.*, 2003). All of these emulsions were prepared with 30% (wt/wt) soybean oil as oily phase and polysorbate 60 and sorbitan monostearate (53:47 ratio) as surfactants. Increasing surfactant concentration resulted in a smaller droplet size and somewhat higher emulsion viscosity.

Concentrated emulsions can be highly viscous (*e.g.*, mayonnaise). However, oil-in-water emulsions commonly used for groundwater remediation are typically much less viscous than pure edible oil and do not require any special equipment for handling. **Figure D.8** shows the viscosity of a commercially available emulsion (60% by weight soybean oil) when diluted in varying amounts of water.

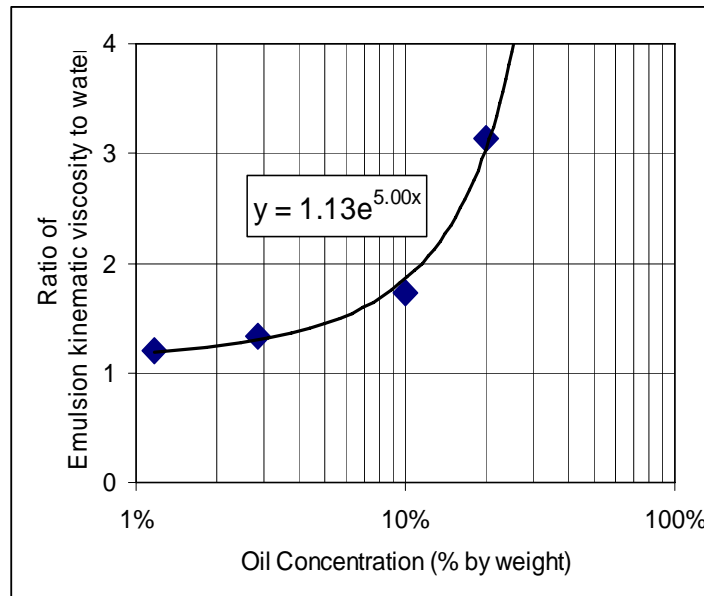
**Table D.6**  
**Representative Oil Droplet Sizes and Dynamic Viscosities of**  
**Soybean Oil Emulsion Preparations** (from Roland *et al.*, 2003)

<b>Emulsion</b>	<b>Mixer</b>	<b>Surfactant Content (%)</b>	<b>Median Droplet Size (µm)</b>	<b>Viscosity (mPa s)<sup>c</sup></b>
H	Hand		69	122
S	Silverson <sup>a</sup>		7	20
D10	Homogenizer <sup>b</sup>	10%	0.3	22
D5	Homogenizer	5%	0.7	12
D2	Homogenizer	2%	2.3	9

<sup>a</sup> Silverson L4R mixer (E.J. Payne Ltd., England) (emulsion S)

<sup>b</sup> MiniDeBEE high-pressure homogenizer (BEEI International Ltd., Israel)

<sup>c</sup> milliPascal seconds = the SI derived unit of dynamic viscosity. The pascal second or kg m<sup>-1</sup> s<sup>-1</sup> is equivalent to 10 poise.



**Figure D.8 Ratio of Emulsion Kinematic Viscosity to Water for EOS 598B Emulsion Diluted with Varying Amounts of Water** (data provided courtesy of EOS Remediation, Inc.)

Viscosity in [Figure D.8](#) is presented as the ratio of emulsion viscosity to water viscosity at 20 °C. The manufacturers typically recommend that this material be diluted 20:1 to 4:1 with water prior to injection (3 to 12% final oil concentration), so the injected emulsion will be between 1.3 and 2.1 times as viscous as water. The somewhat higher viscosity of the emulsion can result in a slight increase in back pressure during the emulsion injection phase, but may also result in somewhat reduced fingering of the injection front.

### D.1.3 Impact of Oil and Emulsion Properties on Material Handling and Injection

**Table D.7** provides information on the viscosity and specific gravity of some typical liquids and common emulsions used for aquifer remediation. At the concentrations typically used for aquifer remediation (3 to 12% oil per volume water), the emulsions have properties similar to milk or cream. Because of their ability to mix evenly in water without outside energy, emulsions can be injected easily using low pressure equipment. Commercial emulsion preparations do not require heating prior to use, even when used at temperatures as low as 10 °C. However, the emulsions should be prevented from freezing as this may damage the emulsion.

**Table D.7**  
**Viscosity Values and Specific Gravity of Some Typical Liquids**

Typical Liquid	centiPoise <sup>a</sup> (cP)	centiStokes (cSt)	Specific Gravity
Water	1	1	1.0
1% Oil-in-water emulsion	1.2	1.2	1.00
Milk	3.2	4	-
5% Oil-in-water emulsion	1.5	1.5	1.00
15% Oil-in-water emulsion	2.4	2.4	0.99
Cream	16.5	20.6	-
Vegetable oil	34.6	43.2	0.91 - 0.95
SAE 30 oil	352	440	0.88 - 0.94
Glycerine	820	650	1.26
Honey	1760	2200	-
Mayonnaise	5000	6250	-

Source: [http://www.engineeringtoolbox.com/dynamic-absolute-kinematic-viscosity-21\\_412.html](http://www.engineeringtoolbox.com/dynamic-absolute-kinematic-viscosity-21_412.html)

<sup>a</sup> centiPoise = centiStokes x specific gravity - where specific gravity is assumed to be 0.8 (except for water). The exact Centipoise of can be calculated: centiPoises (cp) = centiStokes (cSt) x Density.

Note: The pascal second ( $\eta$ ) (Pa s) is the SI derived unit of dynamic viscosity. The pascal second or  $\text{kg m}^{-1}\text{s}^{-1}$  is equivalent to 10 poise. Stokes is a CGS unit of kinematic viscosity. The stokes is defined to be  $1 \text{ cm}^2 \text{ s}^{-1}$ , equivalent to  $10^{-4} \text{ m}^2 \text{ s}^{-1}$ . Kinematic viscosity is defined to be dynamic viscosity (see poise) divided by the density of the liquid.

### D.2 IMPACT OF RESIDUAL EDIBLE OIL ON CONTAMINANT SORPTION

The impact of chlorinated solvent partitioning to the edible oil can be evaluated using the using a retardation factor approach (R) where:

$$R \text{ (unitless)} = \frac{\text{Total mass of contaminant}}{\text{Mass of CAH in aqueous phase}} = \frac{\text{Groundwater velocity}}{\text{Pollutant transport velocity}} \quad (\text{D-1})$$

The retardation factor can be calculated as:

$$R = 1 + \rho_B f_o K_p / n \quad (D-2)$$

where:  $\rho_B$  is the aquifer bulk density ( $\text{g}/\text{cm}^3$ )

$f_o$  is the fraction of oil in the sediment ( $\text{g}/\text{g}$ )

$K_p$  is the oil-water partition coefficient ( $\text{ml}/\text{g}$ )

$n$  is porosity ( $\text{ml}/\text{cm}^3$ ).

This approach assumes that oil-water partitioning is rapid relative to groundwater flow and that partitioning between the oil and water is approximately linear. Long (2004) found that the retardation factor approach provided a reasonably good approximation of chlorinated ethene transport in laboratory columns treated with emulsified soybean oil.

Pfeiffer (2003) examined the partitioning of PCE, TCE, *cis*-1,2-DCE, and VC between water and soybean oil at 20 and 10 °C. Oil-water partitioning was approximately linear suggesting that a retardation factor may be appropriate for estimating pollutant transport velocity in edible oil treated aquifers.  $K_p$  values were higher for the more hydrophobic compounds (Table D.8). PCE partitioning also appeared to be reduced by the presence of other contaminants, indicating a competitive effect. Lower temperatures also reduced partitioning for PCE and TCE in mixtures. However, temperature effects were not significant for *cis*-1,2-DCE and VC. Measured  $K_p$  values were similar to literature values of the octanol-water partition coefficient ( $K_{ow}$ ). The close match between  $K_p$  and  $K_{ow}$  is not surprising given that sorption to octanol is very similar to sorption to vegetable oil.

**Table D.8**  
**Oil-Water Partition Coefficients ( $K_p$ ) for Pure PCE, TCE, *cis*-1,2-DCE, VC and Mixtures of these Materials between Water and Soybean Oil (from Pfeiffer, 2003)**

Chlorinated Ethene	Solubility in water (mg/L)	$K_p$ (ml/g)	$K_{ow}$ (ml/g)
PCE	145 @ 24 °C	1240 (pure compound @ 20 °C) 531 (mixture @ 20 °C) 188 (mixture @ 10 °C)	2500
TCE	1100 @ 18 °C	338 (pure compound @ 20 °C) 373 (mixture @ 20 °C) 171 (mixture @ 10 °C)	263
<i>cis</i> -1,2-DCE	2100 @ 18 °C	61 (pure compound @ 20 °C) 53 (mixture @ 20 °C) 52 (mixture @ 10 °C)	72
VC	2500 @ 18 °C	22 (pure compound @ 20 °C) 22 (mixture @ 20 °C) 26 (mixture @ 10 °C)	23

Estimated retardation factors for PCE, TCE, *cis*-1,2-DCE and VC in aquifers treated with pure edible oil and edible oil emulsions are presented in Table D.9.  $K_p$  values were assumed to be the maximum values reported by Pfeiffer (2003). For illustration purposes, the sediment oil content for pure oil was calculated assuming 50 percent of the aquifer pore space is

occupied by oil (typical residual saturations may be closer to 20 or 30 percent). For emulsion treated aquifers, the sediment oil content was calculated assuming 2 percent residual saturation, a typical value reported by Coulibaly and Borden (2004). Estimated retardation factors for PCE and TCE in an aquifer treated with high residual saturations of pure edible oil are very high, indicating that injection of pure oil can be very effective in sequestering the more hydrophobic contaminants in source areas. For example, the fraction of a contaminant in the aqueous phase will be  $1/R$ , so only  $1/570$  or 0.2 percent of the total PCE mass will be in the aqueous phase. Sequestration will be less effective for *cis*-1,2-DCE and VC because of the much lower  $K_p$  values for these contaminants.

**Table D.9**  
**Estimated Retardation Factors for Different Chlorinated Ethenes**

<b>Comment</b>	<b>Pure Oil</b>	<b>Emulsions</b>
Sediment Bulk Density, $\rho_B$ (g/cm <sup>3</sup> )	1.86	1.86
Porosity (n)	0.3	0.3
Oil fraction (g/g)	0.074	0.003
PCE Retardation Factor ( $K_p = 1240$ )	570	24
TCE Retardation Factor ( $K_p = 338$ )	156	7
<i>cis</i> -1,2-DCE Retardation Factor ( $K_p = 61$ )	29	2.1
VC Retardation Factor ( $K_p = 26$ )	12	1.5

In theory, sorption may substantially delay PCE breakthrough in edible oil emulsion barriers. For example, PCE breakthrough could be delayed by over 2 years in a 10-foot thick emulsion treated barrier with an ambient groundwater velocity of 100 ft/yr. However, in practice, sorption effects are much more limited. Experimental results in laboratory columns have shown that emulsified oil addition results in rapid conversion of PCE and TCE to *cis*-1,2-DCE. Because of its much lower partition coefficient, *cis*-1,2-DCE breakthrough would only be delayed by a few months (Long, 2004).

### **D.3 ENHANCED ANAEROBIC BIOREMEDIATION USING EDIBLE OIL**

Many CAHs can be biodegraded *in situ* by providing a source of biodegradable organic substrate. In practice, the added organic substrates are first fermented to hydrogen (H<sub>2</sub>) and low-molecular weight fatty acids. These short-chain molecules such as acetate, lactate, propionate and butyrate in turn provide carbon and energy for reductive dechlorination. In the reductive dechlorination process, bacteria sequentially replace chlorine atoms with hydrogen forming more reduced degradation products. For example, the chlorinated ethenes are transformed from PCE to TCE to DCE to VC to ethene. If the bacteria are able to obtain metabolically useful energy from reductive dechlorination, this process is referred to as dehalorespiration or halorespiration. Additional information on the microbiology and chemistry of reductive dechlorination can be found in [Appendix E](#) and the Principles and Practices document (AFCEE *et al.*, 2004).

#### **D.3.1 Selection of Oil Type**

A variety of different substrates can be used to generate hydrogen and stimulate reductive dechlorination. Soluble substrates including lactate, molasses and other readily fermented

substrates can be very effective in stimulating reductive dechlorination. However, these substrates must be frequently replenished due to rapid biodegradation and/or transport with flowing groundwater. In contrast, edible oils are slower to degrade and less mobile due to entrapment or sorption to the aquifer matrix. Therefore they do not require frequent injection. This section describes the use of edible oil as a long-lasting, relatively immobile substrate to simulate long-term biodegradation of the CAHs.

Ideal substrates for use in the edible oil process would be: (1) non-toxic, food-grade materials that are sufficiently biodegradable to support complete reductive dechlorination of CAHs; (2) slowly biodegradable in order that residual organic amendment can remain effective in the aquifer for an extended period of time (*e.g.*, 3 to 5 years); and (3) a low unit cost. For example, the United States Department of Agriculture maintains a list of Generally Recognized as Safe (GRAS) materials approved for direct incorporation into food (21CFR173). This list includes a variety of fats and oils including animal and vegetable fats, paraffin, petrolatum, white mineral oil, and several specialty oils.

Petroleum derived oil (*e.g.*, paraffin, petrolatum, and white mineral oil) do not readily ferment to hydrogen and acetate, and consequently would not be good candidates for stimulating reductive dechlorination (He *et al.*, 2002; Borden and Rodriguez, 2005). However, if the target contaminant is nitrate, perchlorate, or another more oxidized material, the petroleum-derived substrates could be useful. Specialty oil including synthetic fats such as olestra can be used to support reductive dechlorination (Borden and Rodriguez, 2005). However, the high cost of the specialty fats will reduce their widespread use. As a consequence, vegetable oils are currently considered to be most useful for stimulating reductive dechlorination in aquifer settings.

Some practitioners have considered employing used fats and oils in lieu of virgin vegetable oil. In theory, recycling spent vegetable oil, such as restaurant waste oil or peanut processing oil, for biodegradation would be less expensive. However, in practice, waste oil are often contaminated with other organics from the cooking processes, are of unknown grade, quality or composition (*i.e.*, mono- or polyunsaturated fats), and may not be available in sufficient quantities from any one source to accommodate the particular project needs. Consequently, this approach has not been implemented to date.

While food-grade materials may not be needed in all cases, use of materials approved for direct incorporation into food may aid in gaining regulatory approval. The requirements for gaining approval for injecting substrates vary from state to state. For example, in North Carolina, the initial proposed use of an injectable substrate required approval from both the State Department of Toxicology and Epidemiology as well as a permit from the UIC Program. In other states such as Florida, the composition of the injectate must be identified and the fate and transport of the ingredients in the amendment must be described to the satisfaction of the regulatory agency. Unlike some other states, Florida also requires information on the potential impact on secondary drinking water quality and an injection permit is needed. Managers should contact the governing state regulatory agency to determine what approvals or permits, if any, may be required to implement the edible oil process. Where cleanup actions are conducted under the Comprehensive Environmental Response, Compensation, and Liability Act (CERCLA) and/or where the DOD is the lead agent, only substantive requirements need to be met. Users are recommended to consult with personnel experienced in implementing *in situ* bioremediation projects in their respective states.

### D.3.2 Anaerobic Fermentation of Edible Oil

This section describes the scientific and metabolic background for understanding how edible oil or oil-in-water emulsions can stimulate anaerobic reductive dechlorination. It demonstrates that although there are subtle differences in the composition of the oils, most of the commercially available oils behave similarly. Most practitioners of the edible oil process use soybean oil because of its availability, good handling characteristics, and relatively low cost.

All triglycerides (edible fats and oils) can be anaerobically fermented to hydrogen and organic acids like acetate. Anaerobic fermentation is believed to occur through a two-step process where the ester linkages between the glycerol and the fatty acids are first hydrolyzed releasing free fatty acids and glycerol to solution. The glycerol then degrades to 1,3-propanediol and subsequently to acetate. Saturated fatty acids undergo further breakdown by *beta*-oxidation resulting in the formation of two molecules of hydrogen (H<sub>2</sub>), one molecule of acetate (C<sub>2</sub>H<sub>3</sub>O<sub>2</sub><sup>-</sup>), and the original molecule of acid appears as a new acid derivative with two less carbon atoms (Sawyer *et al.*, 1994).

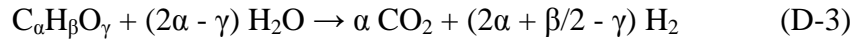


By successive oxidation at the *beta* carbon atom, long-chain fatty acids are whittled into progressively shorter fatty acids and acetic acid. Four hydrogen atoms are released from saturated fatty acids for each acetic acid unit produced (Sawyer *et al.*, 1994). Unsaturated fatty acids undergo the same general process, but release two atoms of hydrogen for each acetic acid unit.

Acetic acid and hydrogen produced in the subsurface by fermentation of edible oil will then be consumed in a variety of different reactions. If high-energy electron acceptors such as oxygen and nitrate are present, the hydrogen and acetic acid will be very rapidly oxidized to carbon dioxide and water. Once these materials are consumed, excess hydrogen and acetate can then be used for reductive dechlorination, or to reduce dissolved sulfate and oxidized forms of manganese and iron in the sediments. Hydrogen and acetic acid may also be fermented to methane. Any hydrogen or acetic acid converted to methane will not be used for reductive dechlorination and can be thought of as 'wasted'. Ideally, one would prefer to minimize methane production to make the most efficient use of the added organic carbon. However, in practice, this does not appear to be feasible. Reducing substrate addition to limit methane production also appears to reduce dechlorination rates. Consequently, excess organic substrate is typically added to provide sufficient substrate for efficient reductive dechlorination and methane production.

The different edible oils do contain different levels of the various fatty acids. As a consequence, one type of oil could potentially be a better electron donor than another. To evaluate this effect, an average chemical formula for each oil was calculated based on the fraction of different fats presented in [Table D.2](#). The electrons released per mole of oil was then calculated according to the following formula:





where:  $\alpha$  is the number of carbon atoms per mole of oil  
 $\beta$  is the number of hydrogen atoms per mole of oil  
 $\gamma$  is the number of oxygen atoms per mole of oil

This formula assumes that any acetate produced in the process will eventually be fermented to hydrogen and carbon dioxide or otherwise beneficially used in the anaerobic biodegradation process. Results of this analysis are presented in **Table D.10** and compared with other common substrates (Sawyer *et al.*, 1994). This analysis shows that there is essentially no difference in the amount of reducing power per gram of oil. However, all of the oils have much more reducing power than other common substrates. For example, 100 pounds of oil has about the same reducing power as 270 pounds of acetate or sugar.

**Table D.10**  
**Average Composition of Different Edible Oils and Electrons Released during Anaerobic Fermentation**

	Atoms per Mole Substrate			Average Molecular Weight	H <sub>2</sub> Released per mole Substrate	Moles H <sub>2</sub> released per gram substrate
	C	H	O			
Acetate	2.0	4.0	2.0	60.1	4.0	0.0666
Lactate	3.0	6.0	3.0	90.1	6.0	0.0666
Glucose	6.0	12.0	6.0	180.2	12.0	0.0666
Soybean	56.3	99.5	6.0	873.1	156.5	0.1792
Corn	56.3	99.9	6.0	873.5	156.6	0.1793
Cottonseed	55.5	99.3	6.0	862.8	154.7	0.1792
Palm	54.2	100.8	6.0	848.5	152.8	0.1800
Peanut	56.8	102.7	6.0	881.4	158.9	0.1803
Olive	56.2	102.7	6.0	875.0	157.8	0.1804
Canola	57.1	102.3	6.0	884.6	159.3	0.1801
Butterfat	50.2	94.0	6.0	793.4	141.4	0.1782
Lard	55.2	102.4	6.0	862.4	155.6	0.1804
Beef Tallow	55.1	102.9	6.0	862.2	155.8	0.1807

Some practitioners have suggested that edible oil high in unsaturated fatty acids (*e.g.*, oleic, linoleic and linolenic) can be used to inhibit methanogenesis, resulting in more efficient use of the added substrate for reductive dechlorination. This is based on the work of Lalman and Bagley (2000 and 2001), who showed that over 30 mg/L of oleic or linoleic acid will inhibit methane production from acetic acid. However, there is no evidence that use of oils high in unsaturated fats will significantly inhibit methanogenesis under *in situ* conditions. Borden and Rodriguez (2005) monitored methane production from a variety of different fats and oils with varying levels of saturated and unsaturated fatty acids. Soybean oil, which is composed of 96% oleic, linoleic and linolenic acids, was a very efficient carbon source for methane production. The small difference in methane production from different oils is not unexpected, since most vegetable oils are naturally high in unsaturated fats. Increasing the unsaturated fat content from 96% for standard soybean oil to 98% for low linolenic acid canola oil can be expected to have negligible effects on methane production.

An alternative approach to increase substrate life would be to use a hydrogenated oil (*e.g.*, fat) with a higher melting point and lower aqueous solubility. Preliminary studies by Borden and Rodriguez (2005) suggest that highly saturated oils do biodegrade somewhat more slowly. However, the benefits of using saturated fats appear to be minor compared to the increased complexity of injecting materials that are solids at ambient temperatures.

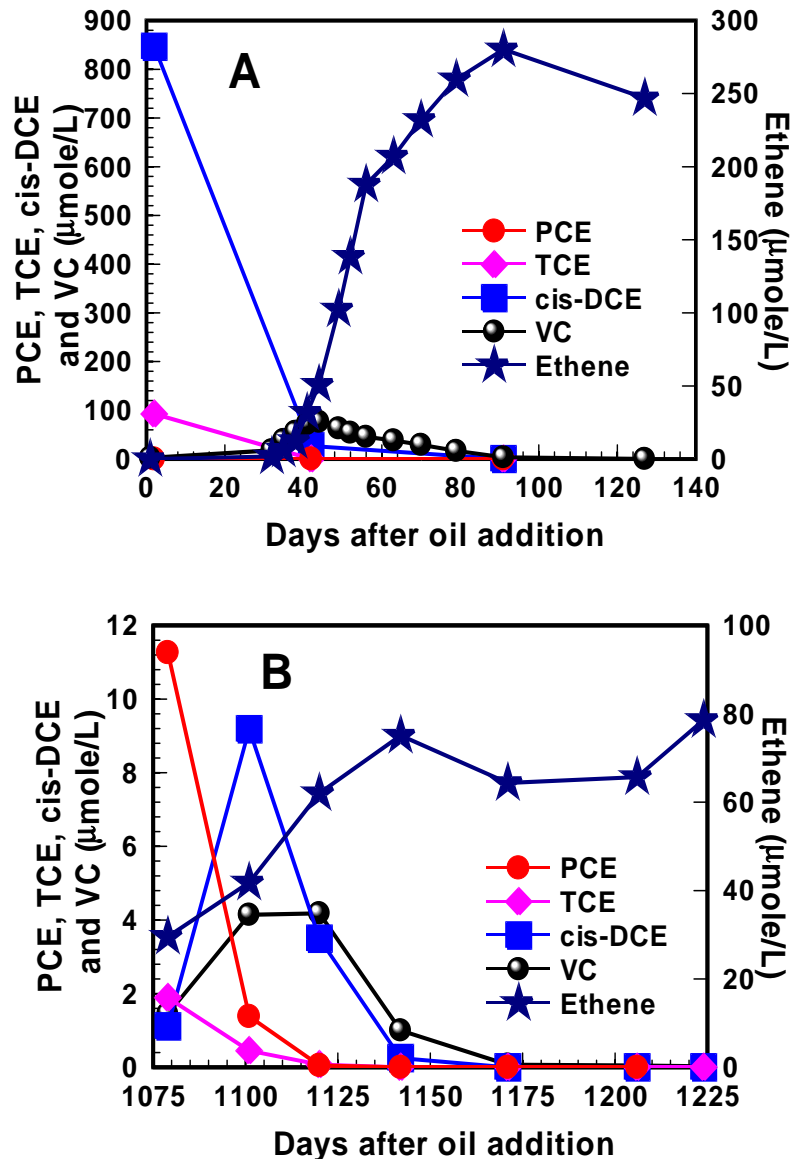
In summary, all edible oils are fermentable to hydrogen and acetate by common subsurface microorganisms. The hydrogen yield (*i.e.*, reducing equivalents) from all common oils is similar and much higher than more oxidized substrates (*e.g.*, acetate, lactate, glucose, etc.). As a consequence, there is no reason to expect that one type of oil would be a significantly better substrate for anaerobic bioremediation than any other oil. When selecting an oil for anaerobic bioremediation, the primary factors to consider are cost, availability, and material handling characteristics (melting point and viscosity). Soybean oil has been used in all AFCEE edible oil projects to date, because of its common availability, good handling characteristics, and relatively low cost.

### **D.3.3 Laboratory Studies of Enhanced Anaerobic Bioremediation using Edible Oil**

Edible oil has been used to stimulate enhanced anaerobic biodegradation of chlorinated solvents and related contaminants in bench-scale studies, pilot studies and large scale remediation projects at over one hundred sites (*e.g.*, Harkness and Farnum, 2004; Lee *et al.*, 2001; Lee *et al.*, 2003; Lieberman *et al.*, 2003; Lindow, 2004; Parsons, 2002d; and Parsons, 2004a). Cases studies describing two of these projects are presented in [Appendix H](#). Additional information on the microbiology and chemistry of reductive dechlorination using soluble and insoluble substrates can be found in the Principles and Practices document (AFCEE *et al.*, 2004), as well as in [Appendix E](#). In this section, we summarize results from a single laboratory microcosm study that evaluated the effect of soybean oil addition on reductive dechlorination of TCE and *cis*-1,2-DCE (Zenker *et al.*, 2000). Additional information on laboratory studies evaluating the effect of edible oil addition on reductive dechlorination is presented by Lee *et al.*, 2000, Sin Chit To (2001), Long (2004), and Rodriguez (2004).

Zenker *et al.* (2000) presents results of an early laboratory microcosm study evaluating the use of edible oil for stimulating reductive dechlorination ([Figure D.9](#)). The microcosms were constructed with aquifer material and groundwater from a chlorinated solvent-contaminated

site in the North Carolina coastal plain and amended with 500 mg/L of liquid soybean oil. **Figure D.9a** shows that TCE and *cis*-1,2-DCE were biodegraded within 50 days to VC. The VC was then transformed to ethene after about 90 days. The microcosms were then repeatedly spiked with additional PCE, but without any additional soybean oil. **Figure D.9b** shows the results from re-spiking of 90 micromoles per liter ( $\mu\text{mole/L}$ ) (or 15 mg/L) PCE on day 1,072. The PCE concentrations fell to  $\sim 11 \mu\text{mole/L}$  (or 1.9 mg/L) due to sorption to the oil. The dissolved and sorbed PCE were then transformed to TCE, *cis*-1,2-DCE, VC, and ethene. However, as the dissolved PCE was depleted, additional PCE desorbed from the oil and was degraded. By day 1,225, all chlorinated solvent concentrations were below analytical detection limits and close to 90% of the injected PCE had been recovered as ethene.



**Figure D.9 Chlorinated Solvent Reductive Dechlorination Over Time.** From one addition of 500 mg/L liquid soybean oil: (a) shortly after microcosm construction; and (b) after repeatedly re-spiking with additional PCE over three years.

These microcosm results demonstrate the following:

1. Addition of edible oil can be very effective in stimulating complete reductive dechlorination of PCE, TCE, *cis*-1,2-DCE and VC to non-toxic end products.
2. Partitioning of the chlorinated solvents into the adsorbed oil does initially reduce aqueous contaminant concentrations. However, a portion of the contaminants will remain in the aqueous phase. As these contaminants are transformed to more reduced degradation products, additional contaminants will partition out of the oil phase into the water, allowing continued biodegradation. If no additional contaminants are added, this process can continue until all chlorinated compounds are degraded to below analytical detection limits with near stoichiometric production of ethene.
3. A one-time addition of soybean oil can support complete dechlorination for over 3 years.

#### **D.4 DISTRIBUTION OF EDIBLE OIL IN THE SUBSURFACE**

This section describes the physical distribution of edible oil and edible oil emulsions when injected into the subsurface, including impacts on hydraulic conductivity.

##### **D.4.1 Distribution of Pure Edible Oil in the Subsurface**

Edible oil is immiscible with water. This means that a distinct interface between the oil and water exists wherever the two fluids are in contact. Because the oil is the non-wetting fluid, the interfaces are concave toward the water. The difference in pressure across the interface is the oil-water capillary pressure (*i.e.*, the capillary pressure is the oil pressure minus the water pressure). The oil pressure always exceeds the water pressure, so the capillary pressure is positive. *As a consequence, pure (neat) oil must be injected under pressure to force the oil to imbibe into a water-saturated aquifer.* Capillary pressure ( $P_c$ ) can be calculated by the relationship:

$$P_c = 2\sigma (\cos \theta)/r \quad (\text{D-4})$$

where:  $\sigma$  is the oil-water interfacial tension

$\theta$  is the oil-water contact angle at sediment surfaces

$r$  is the radius of curvature of the oil-water interface

Pfeiffer (2003) measured  $\sigma$  and  $\theta$  for soybean oil, corn oil, and mixtures of these two materials with PCE and TCE. Results of these measurements are summarized in **Table D.11**. While there were measurable differences between different materials tested, these differences were not dramatic and are not expected to have a significant impact on the overall performance of the process. Interfacial tensions for the different mixtures of the edible oil and PCE or TCE varied between 16 to 34 dynes/cm and the contact angle varied between 27 and 54 degrees. These values are in the range often observed for other common NAPLs.

**Table D.11**  
**Physical Properties of PCE, TCE, Soybean Oil, Corn Oil, and 50:50 Mixtures of Solvents and Edible Oil (Pfeiffer, 2003)**

Material	Interfacial Tension (dynes/cm)	Contact Angle (degrees)
PCE	33.7	44.2
TCE	22.9	53.9
Soybean Oil	24.5	33.0
Corn Oil	33.2	44.8
50% PCE: 50% Soy Oil	16.4	30.9
50% TCE: 50% Soy Oil	16.0	53.7
50% PCE: 50% Corn Oil	19.7	30.7
50% TCE: 50% Corn Oil	18.1	41.5

The excess pressure required to force oil into the sediment pore spaces is called the entry pressure and is directly related to the capillary pressure – large pores have a low entry pressure while small pores have a high entry pressure. As a consequence, when pure oil is injected into a water-wet formation the oil will preferentially occupy the largest pores and be excluded from small pores where the injection pressure at the pore throat is less than the entry pressure.

If pure edible oil is injected at a constant flow rate, the edible oil will first fill the larger pore spaces adjoining the injection point and then begin to migrate out into the formation through higher permeability channels. Since edible oils are 50 to 100 times more viscous than water, friction losses will begin to increase causing pressure to buildup inside the injection point. This pressure buildup will cause oil to flow into the smaller pore spaces, somewhat counteracting the preferential flow through the larger, higher permeability channels.

When edible oil is injected below the water table, there is a tendency for the oil to rise due to buoyancy effects. During the actual injection process, the effect of high injection pressures will greatly exceed buoyancy effects and flow will be radially away from the injection point. However, after injection ends, lateral pressure gradients will dissipate and buoyancy forces may cause the oil to begin to rise. The edible oil will continue upward until a finer grained, lower permeability layer is encountered that restricts upward migration. The oil may then pool below this lower permeability layer. If sufficient oil collects such that the buoyancy force exceeds the entry force of the lower permeability sediments, then the oil will be forced upward through the largest pore spaces of the low permeability layer.

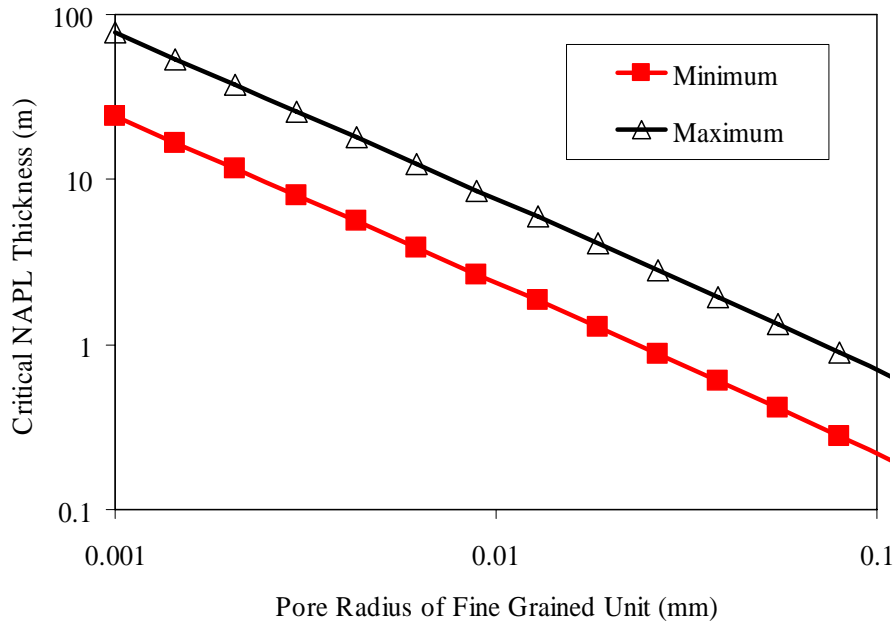
The critical NAPL thickness ( $Z_N$ ) required for upward migration of light NAPLs from a coarse-grained material into a finer-grained material can be estimated from the relationship:

$$Z_N = 2 \sigma \cos \theta (r_F^{-1} - r_C^{-1}) / g (\rho_N - \rho_w) \quad (D-5)$$

where:  $r_F$  and  $r_C$  are the throat radius of the fine and coarse-grained materials  
 $g$  is the acceleration due to gravity ( $9.8 \text{ m/s}^2$ )  
 $\rho_N$  and  $\rho_w$  are the NAPL and water density

**Figure D.10** shows the critical NAPL thickness required for upward migration of a typical edible oil ( $\rho_N = 0.92 \text{ g/cm}^3$ ) from a coarse sand ( $r_C = 1$  millimeter) into a finer grained unit. The maximum line was calculated using  $\sigma = 34$  dynes/cm and  $\theta = 27$  degrees. The minimum

line was calculated using  $\sigma = 16$  dynes/cm and  $\theta = 54$  degrees. These values are based on the measurements by Pfeiffer (2003) and are thought to represent the range of values that might be expected to occur in the field. However, if microbiological processes result in substantial surfactant production, interfacial tensions can be less than 16 dynes/cm.



**Figure D.10 Critical Edible Oil Thickness for Upward Migration as a NAPL from a Coarse Sand ( $r_c = 1$  millimeter) into a Fine-grained Unit**

Results presented in [Figure D.10](#) indicate that continuous layers of fine-grained silt and clay can entrap large amounts of oil, greatly limiting upward migration of pure oil. However, if there are any preferential pathways with larger pore openings, the pure oil could migrate upward through these openings. Even as the oil migrates upward, a portion of the oil will be captured and retained as a residual saturation. The use of a water chase during injection may greatly reduce the volume of continuous phase oil available for upward migration.

As pure edible oil fills the aquifer pore spaces, it greatly reduces hydraulic conductivity and reduces the flow of water. However, as oil flows out into the formation and is replaced by chase water, the permeability to water will recover to some extent. Coulibaly and Borden (2004) measured the effect of soybean oil injection on the permeability of several different sandy sediments in standard laboratory permeameters. The sand filled permeameters were initially saturated with water and then flooded with 3 to 4 pore volumes (PV) of soybean oil followed by water until the permeability stabilized (minimum of 20 PV). These studies demonstrated that pure soybean oil can be distributed in sands with little or no clay.

However, pure soybean oil could not be forced into finer grained clayey sand with the equipment available. These results are consistent with the theoretical results presented above which indicate that pure oil can be easily injected into sands. However, it will be much more difficult to force oil into finer-grained sediments. Also, viscous forces may limit the ability

move oil more than a few feet away from injection points, especially in lower permeability materials.

Soybean oil residual saturation after flushing with over 20 PV of water varied from 22 to 54 percent for the three sands tested (**Table D.12**). Residual saturation was lowest in the most uniform material (Ottawa sand) and highest in the more broadly graded concrete sand. This is consistent with the results of Chatzis and Morrow (1984) who observed that a broader grain size range leads to a higher residual saturation. For the three sands tested, the final permeability after over 30 PV of water displacement was just below half of the initial permeability, indicating that if the oil could be displaced to residual saturation, the permeability loss would not be excessive.

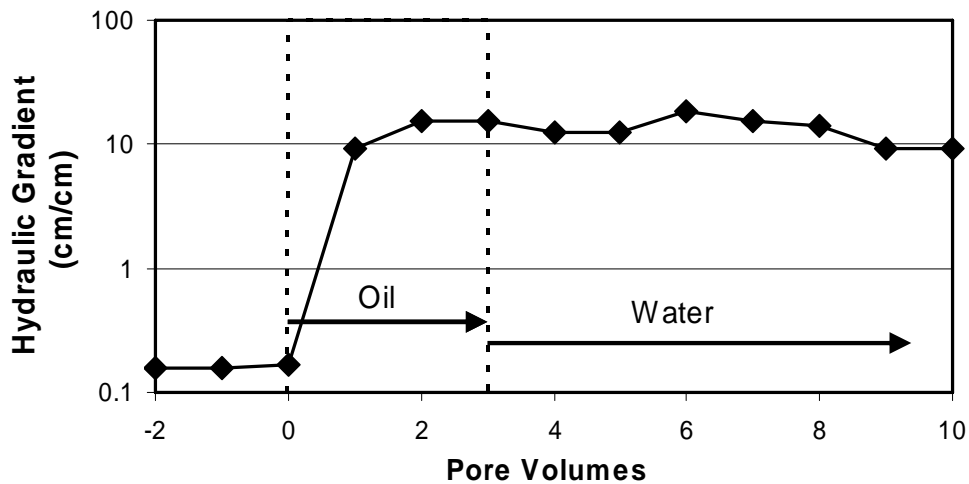
**Table D.12**  
**Residual Saturation and Change in Hydraulic Conductivity Following Injection with Pure Soybean Oil**

Media	D <sub>50</sub> (mm)	D <sub>10</sub> (mm)	Oil Residual Saturation (% by volume of pore space)	Initial Hydraulic Conductivity (K <sub>0</sub> ) (cm/s)	Final Hydraulic Conductivity (K) (cm/s)	K/K <sub>0</sub>
Ottawa Sand	1.07	0.66	21.7 (3.7)	0.427 (0.035)	0.185 (0.057)	46 (12)
Concrete Sand	0.82	0.15	54.2 (7.9)	0.051 (0.002)	0.026 (0.007)	45 (0)
Play Sand	0.30	0.10	36.5 (2.5)	0.027 (0.006)	0.011 (0.001)	46 (18)
Concrete Sand + 5% kaolinite	0.74	0.03	31.0 (0.1)	0.019 (0.004)	0.008 (0.003)	39 (14)

Note: Residual saturation and permeability change are the average of triplicate column tests. Standard deviations are shown in parentheses.

Once soybean oil has been displaced to residual saturation, permeability loss is not excessive. However, extended flushing with water is required to displace the oil to residual saturation. **Figure D.12** shows the hydraulic gradient (centimeters of water head/centimeter) required to pump 2 PV water, 3 PV of liquid soybean oil and then 7 PV of water through Ottawa sand at a constant flow rate. There is an almost two order-of-magnitude increase in the hydraulic gradient during soybean oil injection. Once the oil is displaced to residual saturation, hydraulic conductivity returns to roughly half of the pre-injection value. However, over 7 PV of water flushing are required to achieve this.

In the field, extended flushing with water to reach residual saturation would not be practical. As a consequence, pure edible oil will not be completely displaced to residual saturation and permeability losses can be expected. Large permeability losses may be beneficial when treating source areas, since this will reduce groundwater flow through the source area and the mass flux of contaminants. However, large permeability losses in barriers would not be acceptable since this will cause contaminated groundwater to flow around the barrier and remain untreated.



**Figure D.11** Variation in Hydraulic Gradient during Injection through Ottawa Sand with 3 Pore Volumes of Neat Soybean Oil followed by Plain Water at Constant Flow Rate

#### D.4.2 Distribution of Edible Oil Emulsions in the Subsurface

Edible oil can be distributed in aquifers as oil-in-water emulsions followed by a water chase to enhance the distribution of the oil, or the emulsion can be simply be diluted to the desired total volume. Oil-in-water emulsions are completely miscible with water so the emulsions easily disperse with groundwater after injection. As the oil droplets are transported through the aquifer pore spaces by flowing groundwater, they collide with sediment surfaces and sorb to the aquifer matrix, or are entrapped within pore spaces smaller than the emulsion droplet size. The sediment surfaces gradually become coated with a layer of oil droplets that provides a carbon source for long-term reductive dechlorination. For the best transport, the emulsion should be stable (*e.g.*, non-coalescing); have small, uniform droplets to allow transport in most aquifers; and have a negative surface charge to reduce droplet capture by the solid aquifer matrix.

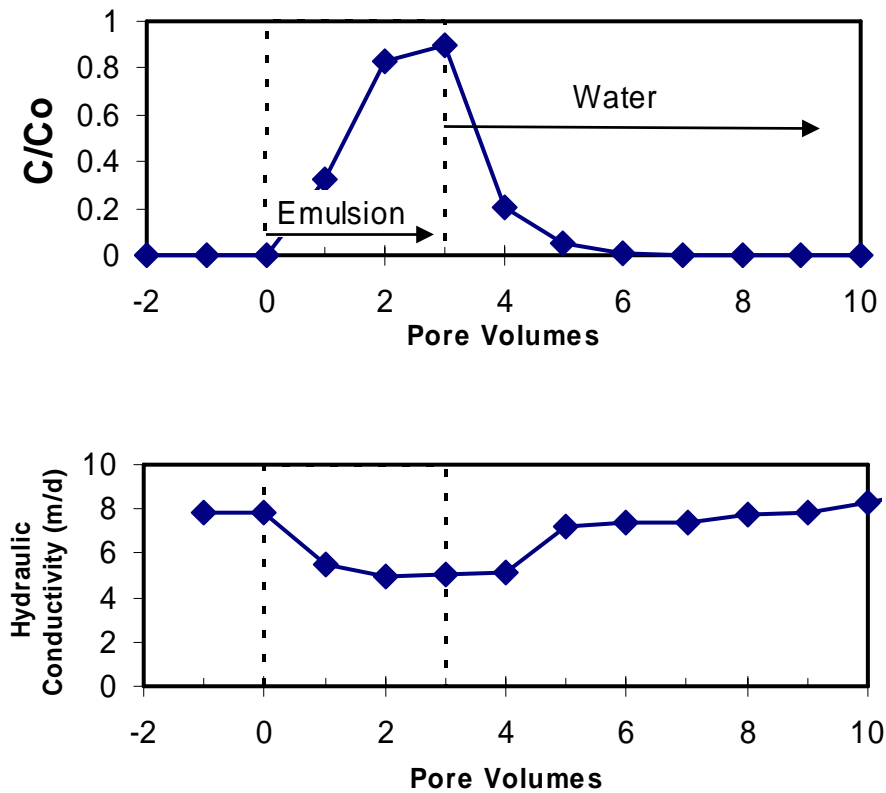
Experimental and mathematical modeling studies by Soo and Radke (1984; 1986a; 1986b) have shown that oil droplets larger than the sediment pores are rapidly removed by straining, which then causes a loss in permeability. However, oil droplets smaller than the sediment pores can be transported significant distances through porous media with low interception by solid surfaces and low permeability loss. Recently, Coulibaly (2003) demonstrated that transport and retention of emulsified soybean oil droplets can be described by deep-bed filtration theory (Westall and Gschwend, 1993; Ryan and Elimelech, 1996; Logan, 1999).

Coulibaly and Borden (2004) conducted column experiments to evaluate emulsion transport and associated permeability loss in sands with varying clay contents. **Figure D.12** shows the variation in emulsion concentration in the column effluent and effective hydraulic conductivity of field sand treated with a fine emulsion. The emulsion concentration is presented as the measured volatile solids (VS) concentration of the column effluent divided by the VS of the injected emulsion ( $C/C_0$ ). During injection, the emulsion rapidly breaks through in the column effluent demonstrating effective transport in sand with over 5 percent



clay. Then during the post-injection water flush, the emulsion rapidly declines to background levels with little evidence of tailing or flushout of trapped emulsion.

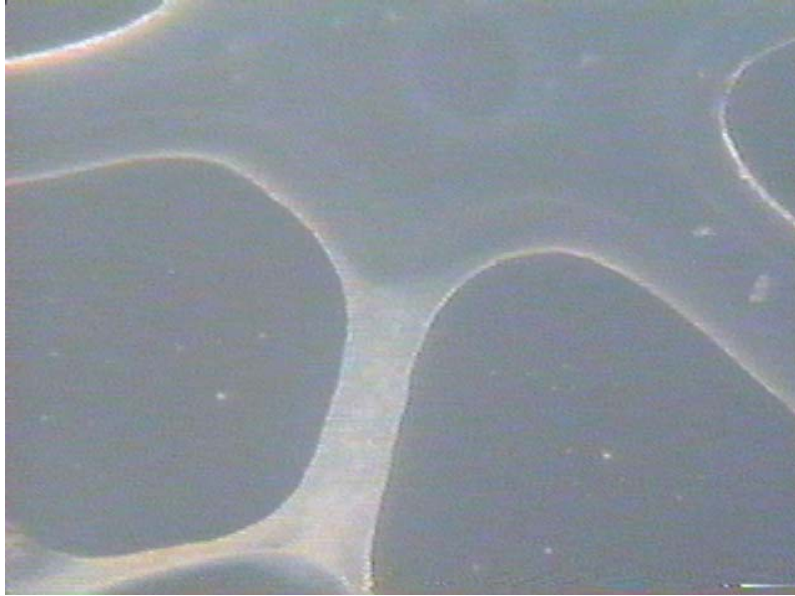
The effective hydraulic conductivity declines to approximately 66 percent of the pre-injection value and then returns to background levels during the water flushing. Most of the observed reduction in hydraulic conductivity is due to the higher viscosity of the emulsion (1.44 centipoise) compared to water (0.95 centipoise) at the ambient temperature (23 °C). However, when an emulsion with larger droplets is injected, the large oil droplets are filtered out, clogging the soil pores causing a permanent hydraulic conductivity loss (Coulibaly and Borden, 2004; Coulibaly *et al.*, 2006; Ullmann, 2004).



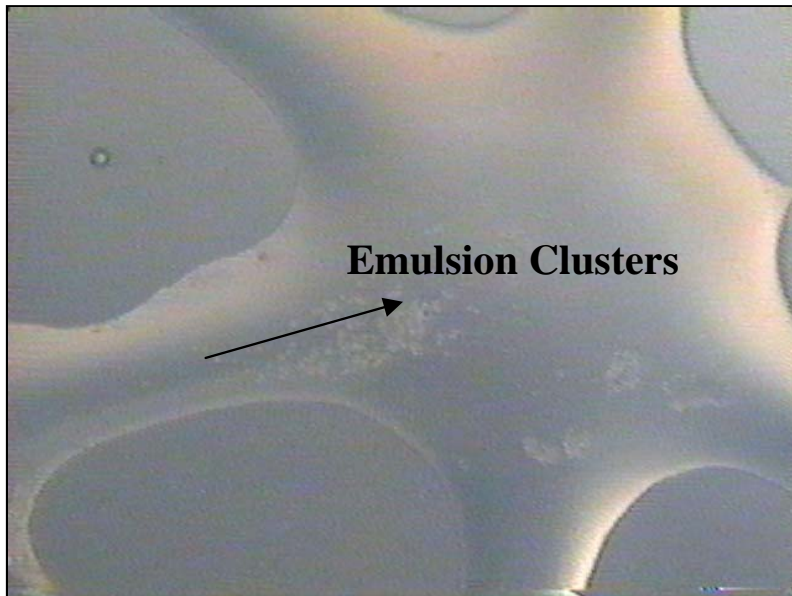
**Figure D.12 Variation in Emulsion Concentration ( $C/C_o$ ) in Column Effluent and Effective Hydraulic Conductivity during Injection in Field Sand with 3 Pore Volumes of Fine Emulsion followed by Plain Water (from Coulibaly and Borden, 2004)**

Sandbox studies conducted by Jung (2003 and 2006) demonstrated that appropriately prepared oil-in-water emulsions can be effectively transported through sands with varying clay content. Oil droplet retention on the sediment surfaces is proportional to the clay content with larger amounts of clay resulting in higher oil retention (Coulibaly and Borden, 2004). Upward migration of the oil droplets does not appear to be a significant issue. When a homogeneous sandbox was treated with emulsified oil and allowed to sit for almost two months, there was no evidence of upward migration of the oil droplets (Jung, 2003 and 2006).

Work by Jain and Demond (2002) showed that droplet capture and associated permeability loss may also be strongly related to the surface charge characteristics of the oil droplets. Depending on the type of surfactant used to prepare the emulsion and the ionic strength of the groundwater, oil droplets may repel each other or they may stick together (flocculate). If they stick together, they can coat the pore walls forming mats of droplets many layers thick. **Figure D.13** shows a photomicrograph of a pore clogged with many tiny emulsion droplets. Each droplet is much smaller than the pore throat. However, when they clump together forming mats, they can clog very large pores (30-70 micron). **Figure D.14** shows how these mats can break off, migrate downgradient and clog other pores. As a consequence, it is very important to use emulsions that do not clump together.



**Figure D.13** Restriction of Flow Due to Emulsion Droplet Deposition Partially Plugging a Pore Throat (from Jain, 2000)



**Figure D.14** Movement of Emulsion Clusters Induced by Increasing the Flow Velocity (from Jain, 2000)

## **APPENDIX E**

### **MICROBIOLOGY OF REDUCTIVE DECHLORINATION**

## **APPENDIX E**

### **MICROBIOLOGY OF REDUCTIVE DECHLORINATION**

#### **E.1 INTRODUCTION**

Natural aquifer systems are complex ecosystems populated by a broad and diverse array of microbial communities. The composition and activity of these microbial communities changes continuously as their environment changes. Alterations in aquifer geochemistry and the availability of substrates and nutrients that can be used to generate energy and support growth and reproduction significantly affect microbial activity.

Anaerobic reductive dechlorination is carried out by only a few metabolic classifications of bacteria, including methanogens, sulfate-reducing bacteria and dechlorinating bacteria. In practice, microorganism capable of degrading PCE and TCE to *cis*-1,2-DCE should be considered ubiquitous in the subsurface environment (AFCEE *et al.*, 2004). However, dechlorination of *cis*-1,2-DCE and VC to ethene appears to be limited only to only a few bacteria, which may not be ubiquitous in the environment (He *et al.*, 2003). The complete degradation of PCE all the way to ethene has only been demonstrated for the species *Dehalococcoides ethenogenes*, the absence of which has been implicated in the persistence of *cis*-1,2-DCE and VC in groundwater. Nonetheless, Flynn *et al.* (2000) demonstrated complete dechlorination of PCE to ethene with a mixed culture that did not contain the *Dehalococcoides* species.

Analysis of contaminant concentration trends can be used to determine whether an ongoing source of chlorinated aliphatic hydrocarbons exists at a site, and whether natural attenuation processes are sufficient to control contaminant plume migration. In some cases, monitored natural attenuation alone may be an adequate and acceptable strategy for managing risks. Even in such cases, the use of enhanced anaerobic bioremediation may be appropriate in order to reduce life-cycle monitoring costs. To enhance anaerobic bioremediation, conditions must be established to support the desired microbial activity and promote microbial proliferation. The primary objective of injecting edible oil into the subsurface is to stimulate the reductive dechlorination of chlorinated solvents. An in-depth discussion of the microbiology of reductive dechlorination can be found in the Principles and Practices document (AFCEE *et al.*, 2004). This appendix provides a brief overview of the most important concepts for understanding the role that microorganisms play in the process.

#### **E.2 MICROBIOLOGY OF REDUCTIVE DECHLORINATION**

The process of anaerobic reductive dechlorination has been well documented. A recent discussion of the overall process can be found in Bradley, 2003. A review of the different environmental factors affecting anaerobic reductive dechlorination is presented in AFCEE *et al.* (2004). The following sections provide a brief description of the process.

##### **E.2.1 Halorespiration and Fermentation**

The most important process for the biodegradation of the more highly chlorinated solvents (*e.g.*, PCE and TCE) is reductive dechlorination. During this process, the chlorinated hydrocarbon is used as an electron acceptor and a chlorine atom is removed and replaced with

a hydrogen atom. In general, reductive dechlorination occurs by sequential dechlorination. For example, the chlorinated ethenes are transformed from PCE to TCE to DCE to VC to ethene. If the bacteria are able to obtain metabolically useful energy from reductive dechlorination, this process is referred to as halorespiration. Depending upon environmental conditions and presence/absence of suitable microbes, this sequence may be interrupted, with other processes acting upon the degradation products.

Reductive dechlorination of chlorinated solvent compounds is associated with the generation of daughter products and an increase in the concentration of chloride ions. Reductive dechlorination affects each of the chlorinated compounds differently. For example, of the chlorinated ethenes, PCE and TCE are the most susceptible to reductive dechlorination because they are the most oxidized (*i.e.*, they yield more energy during the reductive reaction). Conversely, VC is the least susceptible to reductive dechlorination because it is the least oxidized of these compounds. Therefore, the potential exists for VC to accumulate in a treatment system when the rate at which it is generated is greater than the rate at which it degraded. This is a common concern because VC is considered more toxic than the other chlorinated ethenes.

Reductive dechlorination occurs under sulfate-reducing and methanogenic conditions. Because chlorinated compounds are used as electron acceptors during reductive dechlorination, there must be an appropriate electron donor present. The electron donor used by most dechlorinating microbes is molecular hydrogen (H<sub>2</sub>), which may be produced via primary or secondary fermentation of a variety of organic substrates. Potential sources of hydrogen include natural organic matter, fuel hydrocarbons, landfill leachate, or added organic substrates.

Significant progress has been made in recent years in understanding the biochemistry of halorespiration. It is now understood that halorespiration is typically based on the following generalized reduction-oxidation (redox) reaction:



where C-Cl represents a carbon-chloride bond in a chlorinated solvent. In this reaction, hydrogen is the electron donor, which is oxidized, and the chlorinated solvent is the electron acceptor, which is reduced. Although a few other electron donors besides hydrogen have been identified which can drive halorespiration, these compounds also are fermentation products. All of the pure cultures isolated to date, which can completely dechlorinate PCE to ethene, require hydrogen as the electron donor (Maymo-Gatell *et al.*, 1997; Fennell *et al.*, 1997). Therefore, hydrogen appears to be the most important electron donor for halorespiration.

While chlorinated compounds have been observed to be degraded in a variety of laboratory systems, it is now apparent that these systems likely contained at least two distinct guilds of bacteria. One guild ferments the organic carbon to produce hydrogen, and another guild utilizes the hydrogen as an electron donor for halorespiration. Only recently have researchers begun to fully recognize the role of hydrogen as the electron donor in the reductive dechlorination of PCE and TCE (Holliger *et al.*, 1993; Gossett and Zinder, 1996; Smatlak *et al.*, 1996; Ballapragada *et al.*, 1997).

Under natural conditions, fermentation is the process that generates the hydrogen used in reductive dechlorination. Fermentation is a balanced redox reaction in which different portions of a single substrate are oxidized and reduced yielding energy. Fermentation does not require an external electron acceptor, such as oxygen, nitrate, or a chlorinated solvent. Fermentation yields substantially less energy per unit of substrate compared to oxidation reactions, which utilize an external electron acceptor; thus, fermentation generally occurs when these external electron acceptors are not available. Bacterial fermentation can be divided into two categories:

- **Primary fermentation:** The fermentation of primary substrates such as sugars, amino acids and fats yields acetate, formate, carbon dioxide (CO<sub>2</sub>) and hydrogen. Intermediate products that may also be produced in this process include ethanol, lactate, propionate, and butyrate. While primary fermentation often yields hydrogen, production of hydrogen is not required for these reactions to occur.
- **Secondary fermentation:** Fermentation of the intermediate fermentation products including ethanol, lactate, propionate, and butyrate yields acetate, formate, hydrogen, and CO<sub>2</sub>. Bacteria that carry out these reactions are called obligate proton reducers because the reactions must produce hydrogen in order to balance the oxidation of the carbon substrates. These secondary fermentation reactions are energetically favorable only if hydrogen concentrations are very low (10<sup>-2</sup> to 10<sup>-4</sup> atmospheres [atm] or 8,000 nM]to 80 nM dissolved hydrogen, depending on the fermentation substrate). Thus, these fermentation reactions occur only when the produced hydrogen is utilized by other bacteria, such as dechlorinators and methanogens. The process by which hydrogen is produced by one strain of bacteria and utilized by another is called interspecies hydrogen transfer.

In the absence of external electron acceptors, the hydrogen produced by fermentation will be utilized by methanogens (methane-producing bacteria). In this case, the ultimate end products of anaerobic metabolism of carbon substrates will be methane (CH<sub>4</sub>) (the most reduced form of carbon) and CO<sub>2</sub> (the most oxidized form of carbon). However, in the presence of external electron acceptors (*e.g.*, halogenated organics, nitrate, sulfate, etc.) other products will be formed.

There are many carbon substrates which are naturally fermented at chlorinated sites and that result in the generation of hydrogen. Examples of easily fermentable organics include acetone, sugars, and fatty acids. In addition, some groundwater naturally contains high concentrations of organic compounds. The purpose of adding an organic substrate to the subsurface is to provide additional organic carbon that can be fermented to produce hydrogen.

In summary, hydrogen is generated by fermentation of non-chlorinated organic substrates including fuels, naturally-occurring organic carbon, and a variety of other compounds, including carbohydrates, sugars, alcohols, VFAs, and edible oil. Methanogens require fermentation products as substrates; therefore, methane production is clear evidence of *in situ* fermentation. Fermentation produces hydrogen that is the primary electron donor utilized for reductive dechlorination of chlorinated solvents.

### **E.2.2 Anaerobic Cometabolic Dechlorination**

When a chlorinated compound is biodegraded via cometabolism, the degradation is catalyzed by an enzyme or cofactor that is fortuitously produced by the organisms for other purposes. The organism receives no known benefit from the degradation of the chlorinated compound. Rather, the cometabolic degradation of the chlorinated compound may in fact be harmful to the microorganism responsible for the production of the enzyme or cofactor (McCarty and Semprini, 1994).

While cometabolism is best documented in aerobic environments, it also may occur under anaerobic conditions. Anaerobic cometabolic dechlorination has most often been observed in the presence of acetogenic and methanogenic bacteria (Suthersan, 2001). In the field, it is often difficult to distinguish between cometabolic dechlorination and metabolic dechlorination (halorespiration). Because the organisms that cause anaerobic cometabolic dechlorination are ubiquitous in the subsurface, cometabolic dechlorination is likely responsible for some degradation of chlorinated compounds (Gossett and Zinder, 1996).

### **E.2.3 Competing Anaerobic Microbial Processes**

As hydrogen is produced by fermentative organisms, it is rapidly consumed by other bacteria. The utilization of hydrogen by non-fermentors is known as interspecies hydrogen transfer and is required for fermentation reactions to proceed (Wiedemeier *et al.*, 1999). Although hydrogen is a waste product of fermentation, it is a highly reduced molecule, which makes it an excellent high-energy electron donor. A wide variety of bacteria can utilize hydrogen as an electron donor including denitrifiers, iron reducers, sulfate reducers, methanogens, and halorespirators. Thus, the production of hydrogen through fermentation does not, by itself, guarantee that hydrogen will be available for halorespiration. For dechlorination to occur, halorespirators must successfully compete against the other hydrogen utilizers for the available hydrogen.

Smatlak *et al.* (1996) suggest that the competition for hydrogen is controlled primarily by the Monod half-saturation constant  $K_s(\text{H}_2)$ , the concentration at which a specific strain of bacteria can utilize hydrogen at half the maximum utilization rate. They measured  $K_s(\text{H}_2)$  values for halorespirators and methanogens of 100 nM and 1,000 nM, respectively. Based on this result, they suggested that halorespirators would successfully compete for hydrogen only at very low hydrogen concentrations. This implies that the selection of an organic substrate whose fermentation results in a slow, steady, and low-level release of hydrogen (electron donor) over time could maximize dechlorination potential while minimizing methanogenic competition for the available hydrogen.

Ballapragada *et al.* (1997), point out that competition for hydrogen also depends on additional factors including the bacterial growth rate (relative cell yields) and maximum hydrogen utilization rate. While they concluded that dechlorinating bacteria may out-compete methanogens for hydrogen utilization at low hydrogen concentrations, they also concluded that dechlorinators can compete successfully with methanogens up to a hydrogen partial pressure of 100 ppm. Because hydrogen seldom exceeds 100 ppm in methanogenic environments, dechlorinators should normally have an advantage.

In summary, site-specific geochemical characteristics and microbial populations have a significant impact on the rate and relative utilization of electron donor (*i.e.*, hydrogen).

Dechlorinators will likely have a competitive advantage over methanogens at lower hydrogen partial pressures. Biodegradation at higher hydrogen partial pressures would require more electron donor as a larger portion of available hydrogen would be utilized by methanogenic bacteria. Often this is compensated for by increasing the amount of organic substrate added to the system.

### **E.3 BIOAUGMENTATION**

Bioaugmentation is the application of a microbial inoculant comprised of enriched microorganisms developed from the site or of non-native origin to accelerate reductive dechlorination processes in the aquifer. Bioaugmentation may be utilized at a site when an appropriate population of microbial dechlorinators is not present, or is present in low population numbers and not sufficiently active to achieve remediation goals. For chlorinated ethenes, commercial bioaugmentation products are available. These products typically contain the *Dehalococcoides* species.

There is some disagreement among practitioners as to the benefits of bioaugmentation. As stated in the Principles and Practices document (AFCEE *et al.*, 2004), “difficulties or limitations in applying bioaugmentation may be attributed to biotic and abiotic stresses, including limitations of nutrients and growth factors in an uncontrolled environment, suppression by competing native microbial populations, metabolism of other non-targeted compounds, inability to distribute the culture uniformly throughout the treatment zone, and inhibitory geochemical conditions such as pH, redox potential, temperature, and salinity (Suthersan, 2001). Nonetheless, bioaugmentation has been used with clear success (Henssen *et al.*, 2001; Major *et al.*, 2002).” The use of edible oil substrate can be used to enhance the growth and metabolism of indigenous microorganisms capable of degrading chlorinated solvents, or to create anaerobic conditions favorable for amendment of a bioaugmentation culture in the subsurface.



**APPENDIX F**  
**ANALYTICAL PROTOCOLS**

**Table F.1**  
**Soil, Soil Gas, Oil, and Groundwater Analytical Protocols**

<b>Matrix</b>	<b>Analysis</b>	<b>Method/Reference (laboratory/field)</b>	<b>Comments</b>	<b>Data Use</b>	<b>Recommended Frequency of Analysis</b>
Soil	Aromatic and chlorinated hydrocarbons	SW5035/SW8260B (laboratory)		Data are used to determine the extent of soil contamination, the contaminant mass present, and the potential need for source removal	Each soil sampling round
Soil	Total organic carbon (TOC) or Fraction of organic carbon (foc)	SW9060 modified for soil samples (laboratory)	Procedure must be accurate over the range of 0.1–5 percent TOC	The fraction of organic carbon in the aquifer matrix is used to calculate retardation factors for dissolved contaminant transport and to estimate the amount of contaminant mass sorbed to the aquifer matrix.	At initial sampling
Soil	Grain size analysis	ASTM D-422 (geotechnical laboratory)		Indication of aquifer permeability and range of pore throat size. May be difficult to distribute substrate in fine-grained formations with high silt and clay content.	Optional at initial sampling
Soil	Bioavailable Iron (II) and Manganese	Bioassay - Laboratory specialty method by New Horizons (laboratory)	Requires 30 day incubation period	Bioassay with quantification of bioavailable solid-phase ferric iron Fe(III) that is a competing electron acceptor and a source of iron for formation of iron sulfides.	Initial sampling
Soil	Weak Acid Soluble Iron and Manganese	Laboratory specialty method - Microseeps SOP-WC43/WC20 or AFCEE, 2000a	Weak acid extraction with 0.5N HCL	Approximation of bioavailable ferric iron and biogenic ferrous iron. Not recommended if bioassay for ferric iron and manganese is used.	Optional. Pre-injection if potential for biogeochemical reduction.
Soil	Strong Acid Soluble Iron and Manganese	Laboratory specialty method - Microseeps SOP-WC43/WC20 or AFCEE, 2000a	Strong acid extraction with 6.0N HCL	Approximation of total ferric iron and ferrous iron.	Optional. Pre-injection if potential for biogeochemical reduction.
Soil	Acid Volatile Sulfide	Laboratory specialty method - Microseeps SOP-WC43/WC03 or AFCEE, 2000a		Acid volatile sulfide measures sulfur associated with monosulfide minerals. Because iron forms the most common monosulfide minerals, it is used to estimate the concentration of iron monosulfide in the soil matrix.	Optional. One post-injection event after 6 to 12 months if biogeochemical reduction is suspected
Soil	Chromium Extractable Sulfide	Laboratory specialty method - Microseeps SOP-WC43/WC03 or AFCEE, 2000a		Chromium extractable sulfide measures total sulfur associated with sulfide minerals. Following AVS extraction, it is used to estimate the concentration of disulfide minerals and elemental sulfur.	Optional. One post-injection event after 6 to 12 months if biogeochemical reduction is suspected

(continued)

**Table F.1 (continued)**  
**Soil, Soil Gas, Oil, and Groundwater Analytical Protocols**

<b>Matrix</b>	<b>Analysis</b>	<b>Method/Reference (laboratory/field)</b>	<b>Comments</b>	<b>Data Use</b>	<b>Recommended Frequency of Analysis</b>
Soil Gas	Methane, Oxygen, Carbon Dioxide	Field soil gas analyzer calibrated in the field according to the supplier's specifications (field)		Useful for determining biological activity in the vadose zone and generation of biogenic methane.	Each sampling round
Soil Gas	Fuel and Chlorinated Hydrocarbons	USEPA Method TO-3 or TO-4 (laboratory)	Sample collected in summa canister	Useful for determining chlorinated and BTEX compounds (if present) in soil	Annual
Oil	Aromatic and chlorinated hydrocarbons	SW8260B modified (laboratory)	Matrix interference from oil raises detection limit	Data used to determine partitioning of contaminants into edible oil	Each sampling round, if present
Water	Aromatic and chlorinated hydrocarbons	SW8260B (laboratory)		Method of analysis for chlorinated solvents/byproducts, which typically are primary target analytes	Each sampling round
Water	Dissolved oxygen	Dissolved oxygen meter calibrated in the field according to the supplier's specifications (field)	Refer to method A4500 for a comparable laboratory procedure.	Concentrations less than 1 mg/L generally indicate an anaerobic pathway	Each sampling round
Water	Nitrate	IC method E300 (laboratory)		Substrate for microbial respiration if oxygen is depleted	Each sampling round
Water	Iron (II) (Fe <sup>2+</sup> )	Colorimetric Hach Method # 8146 (field)	Filter if turbid.	May indicate an anaerobic degradation process due to depletion of oxygen, nitrate, and manganese	Each sampling round
Water	Sulfate (SO <sub>4</sub> <sup>2-</sup> )	IC method E300 (laboratory)	Do not use the field method if this method is used.	Substrate for anaerobic microbial respiration	Each sampling round
Water	Sulfate (SO <sub>4</sub> <sup>2-</sup> )	Hach method # 8051 (field)	Colorimetric, do not use the fixed-base laboratory method if this method is used.	Same as above, alternative field method.	Each sampling round
Water	Sulfide (H <sub>2</sub> S) or hydrogen sulfide (HS <sup>-</sup> )	Hach Method #8131 (field)		Byproduct of sulfate reduction. Elevated levels may inhibit some biological processes. Indicator of degradation of secondary water quality.	Each sampling round

(continued)

**Table F.1 (Continued)**  
**Soil, Soil Gas, Oil, and Groundwater Analytical Protocols**

<b>Matrix</b>	<b>Analysis</b>	<b>Method/Reference</b>	<b>Comments</b>	<b>Data Use</b>	<b>Recommended Frequency of Analysis</b>
Water	Methane, ethane, and ethene	Kampbell <i>et al.</i> , 1989, or Microseeps AM20GAX (laboratory)	Laboratory specialty method	Elevated levels of methane indicate fermentation is occurring in a highly anaerobic environment. Elevated levels of ethene and ethane (at least an order of magnitude greater than background levels) can be used to infer anaerobic dechlorination.	Each sampling round
Water	Alkalinity	Hach alkalinity test kit model AL AP MG-L (field)	Phenolphthalein method	General water quality parameter used (1) to measure the buffering capacity of groundwater, and (2) as a marker to verify that all site samples are obtained from the same groundwater system;	Each sampling round
Water	Oxidation-Reduction Potential (ORP)	A2580B Measurements made with field meter and ion-specific electrodes (field)	Protect samples from exposure to oxygen. Report results against the hydrogen electrode (Eh) by adding a correction factor specific to the electrode used	The ORP of groundwater influences and is influenced by the nature of the biologically mediated degradation of contaminants; the ORP of groundwater may range from more than 800 mV to less than -400 mV.	Each sampling round
Water	pH	Field probe with direct reading meter calibrated in the field according to the supplier's specifications (field)	Field	Aerobic and anaerobic processes are pH-sensitive	Each sampling round
Water	Temperature	Field probe with direct reading meter (field)	Field only	Well development stabilization parameter.	Each sampling round
Water	Conductivity	E120.1/SW9050, direct reading meter (field)		General water quality parameter used as a marker to verify that site samples are obtained from the same groundwater system	Each sampling round
Water	Carbon Dioxide	Hach Kit Method 8205 (field)		Carbon dioxide is a byproduct of both aerobic and anaerobic degradation. Elevated levels of carbon dioxide indicate microbial activity has been stimulated.	Optional
Water	Chloride	IC method E300 (laboratory) or Hach Chloride test kit model 8-P(field)		Final product of chlorinated solvent reduction.	Each sampling round

(continued)

**Table F.1 (Continued)**  
**Soil, Soil Gas, Oil, and Groundwater Analytical Protocols**

<b>Matrix</b>	<b>Analysis</b>	<b>Method/Reference</b>	<b>Comments</b>	<b>Data Use</b>	<b>Recommended Frequency of Analysis</b>
Water	Bromide and Iodide	IC Method EPA 300.0 (laboratory) or field meter (field)		Used as a conservative groundwater tracer. Indicator parameter for tracer tests only.	Only used with tracer testing.
Water	Major Cations (arsenic, selenium, iron, and manganese)	SW6010B (laboratory)		Some metals may be more mobile under highly reducing conditions. Can be used to evaluate potential adverse impacts to water quality , or for evaluating the potential for biogeochemical reduction.	Optional. Recommended if secondary water quality is a concern
Water	Total or Dissolved Organic Carbon (TOC/DOC)	SW9060 (laboratory)		Indicator of substrate distribution and strength.	Each sampling round
Water	Total Inorganic Carbon (TIC)	RSKSOP 265/0 or Microseeps Method		Indicator of organic carbon that has been degraded to inorganic byproducts.	Optional
Water	Dissolved Hydrogen	Specialty Laboratory Method – RSKSOP-196 or Microseeps AM20GAX	Specialized analysis with difficult sample collection	Determine terminal electron accepting process. Predicts the possibility for reductive dechlorination.	One round of sampling as a diagnostic tool
Water	Chemical Oxygen Demand (COD)	EPA Method 410.4 or 410.1 (laboratory)		A measure of the oxygen required to oxidize all compounds, both organic and inorganic, in water. Used to determine material load in groundwater subject to oxidation.	Only recommended if secondary water quality is a concern
Water	Biological Oxygen Demand (BOD)	EPA Method 415.1 (laboratory)		An indirect measure of the concentration of biologically degradable material present in organic wastes.	Only recommended if secondary water quality is a concern
Water	Total Dissolved Solids (TDS)	E160.3		General water quality indicator parameter.	Only recommended if secondary water quality is a concern
Water	Volatile Fatty Acids (VFAs)	Laboratory specialty method. RSKSOP 112 or Microseeps AM21 G or AM23G		Indicator of substrate distribution and degradation products of more complex substrates ( <i>e.g.</i> , carbohydrates or vegetable oils). VFAs may be used as electron donors or fermented to produce molecular hydrogen for anaerobic dechlorination.	Optional. Useful as a diagnostic tool.
Water	Phospholipid Fatty Acids (PLFAs)	Laboratory specialty method		Indicator of biomass and general composition of the microbial population. Can determine relative levels of microbial stress or starvation.	Only recommended as a diagnostic tool.

(continued)

**Table F.1 (Concluded)**  
**Soil, Soil Gas, Oil, and Groundwater Analytical Protocols**

Matrix	Analysis	Method/Reference	Comments	Data Use	Recommended Frequency of Analysis
Water	Compound-specific isotope analysis (carbon)	Laboratory specialty method		May distinguish between contaminant degradation and non-destructive attenuation processes (e.g., partitioning). May distinguish between biotic and biogeochemical reduction processes.	Only recommended as a diagnostic tool.
Water	Molecular Screening of 16S rRNA for <i>Dehalococcoides</i> species	Laboratory specialty method - Real-time Polymerase Chain Reaction	Specialty Laboratory Method (e.g., Sirem Laboratories or Microbial Insights)	Quantitative identification of microorganisms based on species-specific primers.	Recommended when dechlorination is incomplete.
Water	Quantitative gene detection	Laboratory specialty method		Quantitative screening for genes associated with vinyl chloride reduction to ethene ( <i>vcrA</i> and <i>bvcA</i> genes) indicates whether the <i>Dehalococcoides</i> population detected has the potential for complete dechlorination of chlorinated ethenes	Recommended when dechlorination is incomplete.

**NOTES:**

- \* Analyses other than those listed in this table may be required for regulatory compliance.
- 1. "Hach" refers to the Hach Company Catalog, 2006.
- 2. "A" refers to *Standard Methods for the Examination of Water and Wastewater*, 18th edition, 1992.
- 3. "E" refers to *Methods for Chemical Analysis of Water and Wastes*, USEPA, 1983.
- 4. "SW" refers to the *Test Methods for Evaluating Solid Waste, Physical, and Chemical Methods*, SW-846, USEPA, 3rd edition, 1986.
- 5. "ASTM" refers to the *American Society for Testing and Materials*.

**Table F.2  
Analytical Methods and Data Quality**

<b>Matrix</b>	<b>Analysis</b>	<b>Method/Reference</b>	<b>Minimum Limit of Quantification</b>	<b>Sample Containers and Volume</b>	<b>Sample Preservation and Maximum Holding Time</b>	<b>Potential Data Quality Problems</b>
Soil	Aromatic and chlorinated hydrocarbons	SW5035/SW8260B	1.0 mg/Kg	Encore <sup>®</sup> Sampler (3X) Glass jar w/ Teflon <sup>®</sup> septum (4 oz.)	Cool to 4°C ; 48 hours until extraction for Encore <sup>®</sup> Sampler, or 14 days if preserved in the field using methanol or Na <sub>2</sub> S <sub>2</sub> O <sub>3</sub> solution.	Volatiles lost during shipment to laboratory; extraction in the field preferred.
Soil	Fraction of organic carbon (foc)	SW9060 modified for soil samples	0.1 percent	Collect 100 gm of soil in a glass container with Teflon <sup>®</sup> lined cap (4 oz.)	Cool to 4°C; 28 days	Samples should be collected from transmissive intervals.
Soil	Grain size analysis	ASTM D-422 (geotechnical laboratory)	Percent by weight	Collect 1 gallon plastic bag	None	
Soil	Bioavailable Iron (III) and Manganese	Bioassay - Laboratory specialty method by New Horizons (laboratory)	200 mg/kg	Core samples collected into plastic liners, or into jars purged with nitrogen. (see Wilken, 2006)	Wrap or cap tightly to prevent aeration, freeze immediately. (see Wilken, 2006)	Sample must not be allowed to oxidize
Soil	Weak Acid Soluble Iron and Manganese	Laboratory specialty method - Microseeps SOP-WC43/WC20	200 mg/kg	Core samples collected into plastic liners, or into jars purged with nitrogen. (see Wilken, 2006)	Wrap or cap tightly to prevent aeration, freeze immediately. (see Wilken, 2006)	Sample must not be allowed to oxidize
Soil	Strong Acid Soluble Iron and Manganese	Laboratory specialty method - Microseeps SOP-WC43/WC20	200 mg/kg	Core samples collected into plastic liners, or into jars purged with nitrogen. (see Wilken, 2006)	Wrap or cap tightly to prevent aeration, freeze immediately. (see Wilken, 2006)	Sample must not be allowed to oxidize
Soil	Acid Volatile Sulfide	Laboratory specialty method - Microseeps SOP-WC43/WC03	200 mg/kg	Core samples collected into plastic liners, or into jars purged with nitrogen. (see Wilken, 2006)	Wrap or cap tightly to prevent aeration, freeze immediately. (see Wilken, 2006)	Sample must not be allowed to oxidize
Soil	Chromium Extractable Sulfide	Laboratory specialty method - RSKSOP 234/0 or Microseeps SOP-WC43/WC03	200 mg/kg	Core samples collected into plastic liners, or into jars purged with nitrogen. (see Wilken, 2006)	Wrap or cap tightly to prevent aeration, freeze immediately. (see Wilken, 2006)	Sample must not be allowed to oxidize

(continued)

**Table F.2 (Continued)**  
**Analytical Methods and Data Quality**

<b>Matrix</b>	<b>Analysis</b>	<b>Method/Reference</b>	<b>Minimum Limit of Quantification</b>	<b>Sample Containers and Volume</b>	<b>Sample Preservation and Maximum Holding Time</b>	<b>Potential Data Quality Problems</b>
Soil Gas	Methane, Oxygen, Carbon Dioxide	Field Soil Gas Analyzer	1.0 percent (volume/volume)	Reusable 3-liter Tedlar bags.	Analyze immediately	Instrument must be properly calibrated.
Soil Gas	Fuel and Chlorinated Hydrocarbons	USEPA Method TO-14 or TO-03	1.0 ppm (volume/volume)	1-liter Summa Canister	14 days	Potential for atmospheric dilution during sampling.
Oil	Aromatic and chlorinated hydrocarbons	SW8260B modified (laboratory)	1.0 mg/L	Collect oil samples in a 40 mL VOA vial	Cool to 4°C	Results subject to interference from oil compounds.
Water	Aromatic and chlorinated hydrocarbons	SW8260B	USEPA or State MCLs	Collect water samples in 3X 40 mL VOA vials	Preserve to pH <2 with acid preservative, cool to 4°C. Analyze within 14 days.	Volatilization during shipment and biodegradation due to improper preservation.
Water	Dissolved Oxygen	Dissolved oxygen meter	0.2 mg/L	Measure dissolved oxygen onsite using a flow-through cell		Improperly calibrated electrodes or bubbles behind the membrane or a fouled membrane or introduction of atmospheric oxygen during sampling
Water	Nitrate/Nitrite as Nitrogen (N)	EPA 353.1 or EPA 353.2	0.1 mg/L	Collect at least 40 mL of water in a glass or plastic container	Preserve with H <sub>2</sub> SO <sub>4</sub> to pH < 2, cool to 4°C; 28 days.	Must be preserved
Water	Nitrate as NO <sub>3</sub>	IC method E300.0	0.1 mg/L	Collect at least 40 mL of water in a glass or plastic container	Cool to 4°C; 48 hours	
Water	Iron (II) (Fe <sup>2+</sup> )	Colorimetric (Chemetrics Iron Test Kit K-6210) or Hach Method # 8146	0.5 mg/L	Vacuum ampoules or collect 100 mL of water in a headspace-free container	Analyze as soon as possible	Possible interference from turbidity (must filter if turbid). Keep out of sunlight
Water	Sulfate (SO <sub>4</sub> <sup>2-</sup> )	IC method E300.0	5.0 mg/L	Collect at least 40 mL of water in a glass or plastic container; cool to 4°C	Cool to 4°C; 28 days.	Fixed-base
Water	Sulfate (SO <sub>4</sub> <sup>2-</sup> )	Chemetrics kit K-9203 or Hach method # 8051	5.0 mg/L	Collect at least 100 mL of water in a glass or plastic container	Keep Cool, analyze within hours	Possible interference from turbidity (must filter if turbid)

(continued)



**Table F.2 (Continued)**  
**Analytical Methods and Data Quality**

<b>Matrix</b>	<b>Analysis</b>	<b>Method/Reference</b>	<b>Minimum Limit of Quantification</b>	<b>Sample Containers and Volume</b>	<b>Sample Preservation and Maximum Holding Time</b>	<b>Potential Data Quality Problems</b>
Water	Sulfide (H <sub>2</sub> S) or hydrogen sulfide (HS <sup>-</sup> )	Hach method # 8131	5.0 mg/L	Collect at least 100 mL of water in a glass or plastic container	Analyze immediately	Possible interference from turbidity (must filter if turbid)
Water	Methane, ethane, and ethene	Kampbell <i>et al.</i> , 1989 or Microseeps AM20GAX	1.0 µg/L	Collect water samples in 2X 40 mL VOAs with Teflon-lined caps, with out headspace	Add H <sub>2</sub> SO <sub>4</sub> to pH <2, cool to 4°C; 14 days. Alternatively, 7 days if unpreserved.	Sample should be preserved against biodegradation
Water	Alkalinity	Hach alkalinity test kit model AL AP MG-L	20 mg/L	Collect 100 mL of water in glass container	Analyze sample within 24 hours of collection	
Water	Oxidation-reduction potential (ORP)	Field probe with direct reading meter	Plus or minus 400 mV	Measure in a flow-through cell	Analyze immediately	Improperly calibrated electrodes or introduction of atmospheric oxygen during sampling
Water	pH	Field probe with direct reading meter	0.1 standard pH units	Measure in a flow-through cell , or collect 250 mL of water in a glass or plastic container	Analyze immediately	Improperly calibrated instrument; time sensitive
Water	Temperature	Field probe with direct reading meter	0.1 degrees Celsius	Measure in a flow-through cell	Analyze immediately	Improperly calibrated instrument; time sensitive
Water	Conductivity	Field probe with direct reading meter	50 µS/cm <sup>2</sup>	Measure in a flow-through cell , or collect 250 mL of water in a glass or plastic container	Analyze immediately	Improperly calibrated instrument
Water	Carbon Dioxide	Hach Kit Method #8205	10 mg/L	Collect 100 mL of water in glass container	Analyze immediately	Possible interference from turbidity
Water	Chloride (Lab)	IC method E300.1 or titrimetric method E325.3	1.0 mg/L	Collect 125 mL of water in a glass container	Cool to 4°C, 28 days.	Beware of elevated natural background levels
Water	Chloride (Field)	Hach Chloride test kit model 8-P	1.0 mg/L	Collect 100 mL of water in a glass container, cool	Analyze within 24 hours	Possible interference from turbidity
Water	Bromide and Iodide	IC Method EPA 300.0	1.0 mg/L	Collect 500 mL of water in a plastic container	Cool to 4°C; 28 days	

(continued)

**Table F.2 (Continued)**  
**Analytical Methods and Data Quality**

Matrix	Analysis	Method/Reference	Minimum Limit of Quantification	Sample Containers and Volume	Sample Preservation and Maximum Holding Time	Potential Data Quality Problems
Water	Major Cations (arsenic, selenium, iron, and manganese)	SW6010B	1.0 mg/L	Collect 500 to 1,000 liter of water in a glass or plastic container	Preserve with HNO <sub>3</sub> <sup>-</sup> to pH <2; 6 months	Possible colloidal interferences
Water	Total or Dissolved Organic Carbon (TOC/DOC)	SW9060	0.1 mg/L	Collect 250 mL of water in plastic container	Add H <sub>2</sub> SO <sub>4</sub> to pH <2, cool to 4°C; 28 days	
Water	Total Inorganic Carbon (TIC)	Microseeps Method	0.1 mg/L	Collect 250 mL of water in plastic container	Add H <sub>2</sub> SO <sub>4</sub> to pH <2, cool to 4°C; 28 days	
Water	Dissolved Hydrogen	Specialty Laboratory Method – Microseeps AM20GAX	0.1 nM	Sampled at well head requires the production of 100mL per minute of water for 30 minutes	Collect 100–250 mL of water in a glass or plastic container or bubble strip method (Chappelle <i>et al.</i> , 1997)	Sample must equilibrate
Water	Chemical Oxygen Demand (COD)	EPA Method 410.4 or 410.1 (laboratory)	1.0 mg/L	Collect 125 mL of water in plastic container	Add H <sub>2</sub> SO <sub>4</sub> to pH <2, cool to 4°C; 28 days	
Water	Biochemical Oxygen Demand (BOD)	EPA Method 415.1 (laboratory)	1.0 mg/L	Collect 1,000 mL of water in plastic container	Cool to 4°C; 48 hours	
Water	Total Solids (Total Residue)	E160.3	10 mg/L	Collect 250 mL of water in plastic container	Cool to 4°C; 7 days	
Water	Volatile Fatty Acids (VFAs)	Laboratory specialty method – Microseeps AM21 or AM23G	10 mg/L	Collect water samples in 2X 40 mL VOAs with Teflon-lined caps	Cool to 4°C; 14 days	See laboratory for specific sampling and preservation requirements
Water	Phospholipid Fatty Acids (PLFAs)	Laboratory specialty method – <i>e.g.</i> , Microbial Insights	Laboratory specific	See laboratory for specific sampling and preservation requirements	See laboratory for specific sampling and preservation requirements	
Water	Stable Isotope Fractionation (carbon)	Laboratory specialty method	Laboratory specific	See laboratory for specific sampling and preservation requirements	See laboratory for specific sampling and preservation requirements	

(continued)

**Table F.2 (Concluded)**  
**Analytical Methods and Data Quality**

<b>Matrix</b>	<b>Analysis</b>	<b>Method/Reference</b>	<b>Minimum Limit of Quantification</b>	<b>Sample Containers and Volume</b>	<b>Sample Preservation and Maximum Holding Time</b>	<b>Potential Data Quality Problems</b>
Water	Molecular Screening of 16S rRNA for <i>Dehalococcoides</i> species	Laboratory specialty method - Real-time Polymerase Chain Reaction	Specialty Laboratory Method (e.g., Sirem Laboratories or Microbial Insights)	See laboratory for specific sampling and preservation requirements	See laboratory for specific sampling and preservation requirements	
Water	Quantitative gene detection	Laboratory specialty method	Laboratory specific	See laboratory for specific sampling and preservation requirements	See laboratory for specific sampling and preservation requirements	

**APPENDIX G**  
**EXAMPLE SUBSTRATE CALCULATIONS**

## APPENDIX G

### EXAMPLE SUBSTRATE CALCULATIONS

Practitioners of enhanced *in situ* anaerobic bioremediation and vendors of bioremediation products use varying methods to determine how much substrate to apply. For slow-release substrates that are applied in a single or infrequent application, spreadsheets are typically employed that calculate substrate requirements based on site-specific conditions. This appendix provides an example of determining how much edible oil substrate to apply based on spreadsheet calculations using input from site-specific data.

As described in [Section 4.2](#) of this edible oil protocol, estimating how much edible oil substrate is needed is typically based on either 1) the stoichiometric demand for hydrogen, or 2) retention of oil in the aquifer matrix. In many cases, the retention of oil will be the determining factor for the amount of oil that is needed for effective treatment. Other approaches have been used. For example, early applications of edible oil simply specified a target residual oil saturation of the effective pore space of the treatment zone ([Table D.5](#)), or applied a design factor to the stoichiometric hydrogen demand without regard to the adsorptive properties of the aquifer matrix.

The example provided here is for a permeable biobarrier (linear) design based on a calculation tool developed and provided courtesy of Solutions IES, Inc. and EOS Remediation, Inc. The spreadsheet used here for illustration is from a biobarrier pilot test described in Solutions IES (2005). Calculations for a source area design are similar, where injection wells are located in a grid pattern versus a linear pattern. The spreadsheet ([Figure G.1](#)) contains seven sections (A through G). A brief description of each section is provided below. Additional information regarding the input data and its significance in the substrate calculations is provided in [Section 4.2](#).

#### **Section A: Treatment Zone Dimensions**

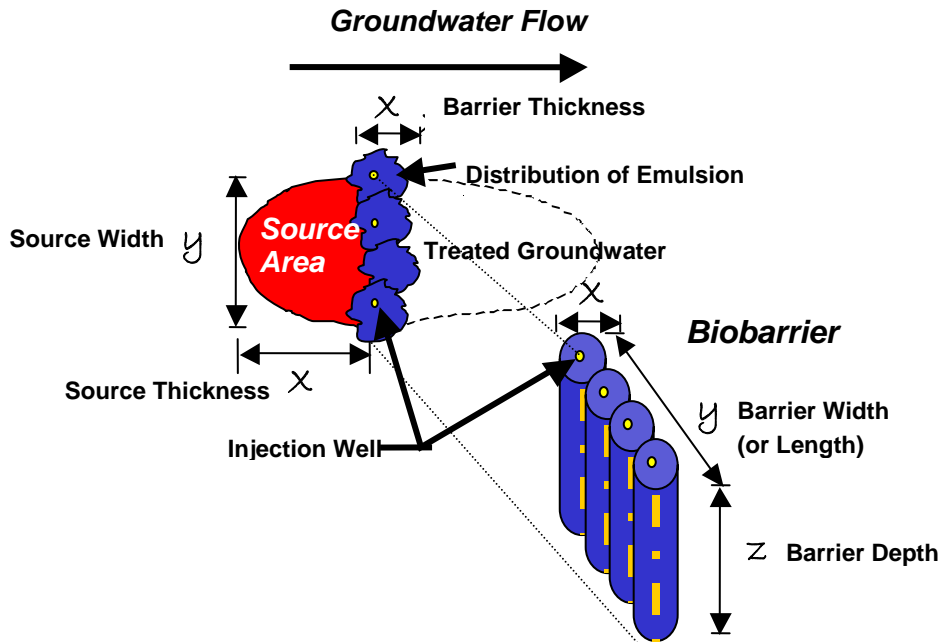
The user enters the dimensions of the biobarrier or source area treatment according to [Figure G.2](#). **Width** ( $y$ ) is defined as the dimension of treatment zone perpendicular to groundwater flow, which may also be referred to as the length of a biobarrier. **Thickness** ( $x$ ) is defined as the dimension of the treatment zone in the direction of groundwater flow, and is directly proportional to the residence time of contaminants in the reaction zone. **Depth** ( $z$ ) is defined as the vertical dimension of the treatment zone, calculated by the spreadsheet from data input for the minimum depth to contamination and the maximum depth to contamination.

#### **Section B: Site Hydrogeologic Data**

Site-specific hydrogeologic data is entered and is used to calculate the rate of groundwater flow through the biobarrier or treatment area. Data required for entry includes effective porosity ( $n_e$ ), hydraulic conductivity ( $K$ ), and hydraulic gradient ( $dh/dl$ ). The spreadsheet then calculates a seepage velocity ( $v_x$ ) and groundwater discharge ( $Q$ ) into/out of the treatment zone using data from Section A.

Section A: Barrier Dimensions							
Width of proposed barrier perpendicular to groundwater flow	50	ft	15.2	m			
Minimum depth to contamination	5	ft	1.5	m			
Maximum depth of contamination	15	ft	4.6	m			
Barrier thickness parallel to groundwater flow	5.0	ft	1.5	m			
Treatment thickness	10	ft	3.0	m			
Surface area of barrier face	500	ft <sup>2</sup>	46	m <sup>2</sup>			
Section B: Site Hydrogeologic Data							
Total Porosity		(decimal)					
Effective Porosity	0.30	(decimal)					
Hydraulic Conductivity	22	ft/day	7.8E-03	cm/sec			
Hydraulic Gradient	0.003	ft/ft					
Seepage velocity (V <sub>s</sub> )	0.2200	ft/day	0.0671	m/day			
Groundwater flowrate through barrier (Q)	247	gal/day	934	L/day			
Section C: Barrier Design Lifespan For One Application							
Total groundwater volume treated over design life	3	year(s)	270,290	gallons	1,023,276	L	
					typical values 5 to 10 years		
Section D: Electron Acceptors							
Inputs	Typical Value	GW Conc. (mg/L)	MW (g/mole)	e <sup>-</sup> equiv./mole	Stoichmetry Contaminant/H <sub>2</sub> (wtwt H <sub>2</sub> )	Hydrogen Demand (g H <sub>2</sub> )	
Dissolved Oxygen (DO)	0 to 8	5.78	32.0	4	7.94	745.185242	
Nitrate Nitrogen (NO <sub>3</sub> <sup>-</sup> - N)	1 to 10	14.42	62.0	5	12.30	1199.2766	
Sulfate (SO <sub>4</sub> <sup>2-</sup> )	10 to 500	28.56	96.1	8	11.91	2453.1639	
Tetrachloroethene (PCE), C <sub>2</sub> Cl <sub>4</sub>		0.086	165.8	8	20.57	4.27882938	
Trichloroethene (TCE), CHCl <sub>2</sub> CCl <sub>3</sub>		0.131	131.4	6	21.73	6.16984107	
cis-1,2-dichloroethene (c-DCE), C <sub>2</sub> H <sub>2</sub> Cl <sub>2</sub>			96.9	4	24.05		
Vinyl Chloride (VC), CH <sub>2</sub> =CCl <sub>2</sub>			62.5	2	31.00		
Carbon tetrachloride, CCl <sub>4</sub>			153.8	8	19.08		
Chloroform, CHCl <sub>3</sub>			119.4	6	19.74		
sym-tetrachloroethane, C <sub>2</sub> H <sub>2</sub> Cl <sub>4</sub>			167.8	8	20.82		
1,1,1-Trichloroethane (TCA), CH <sub>3</sub> CCl <sub>3</sub>		22.7	133.4	6	22.06	1052.97021	
1,1-Dichloroethane (DCA), CH <sub>3</sub> CHCl <sub>2</sub>		0.093	99.0	4	24.55	3.87699389	
Chloroethane, C <sub>2</sub> H <sub>5</sub> Cl			64.9	2	32.18		
Perchlorate, ClO <sub>4</sub> <sup>-</sup>		12	99.4	8	12.33	995.791165	
Hexavalent Chromium, Cr(VI)			52.0	3	17.20		
User added	1,1-DCE	0.62	96.9	4	24.04	26.3959934	
User added							
User added							
Section E: Additional Hydrogen Demand and Carbon Losses							
Generation (Potential Amount Formed)	Typical Value	GW Conc. (mg/L)	MW (g/mole)	e <sup>-</sup> equiv./mole	Stoichmetry Contaminant/H <sub>2</sub> (wtwt H <sub>2</sub> )	Hydrogen Demand (g H <sub>2</sub> )	DOC Flux (moles)
Estimated Amount of Fe <sup>2+</sup> Formed	10 to 100	50	55.8	1	55.41	923.412643	
Estimated Amount of Manganese (Mn <sup>2+</sup> ) Formed			54.9	2	27.25		
Estimated Amount of CH <sub>4</sub> Formed	5 to 20	10	16.0	8	1.99	5143.10439	
Target Amount of DOC to Release	60 to 100	60	12.0				5111.69
Note:							
Calculations assume:							
1.) all reactions go to completion during passage through emulsified edible oil treated zone; and,							
2.) perfect reaction stoichiometry.							
Section F: Substrate Requirement Calculations Based on Hydrogen Demand and Carbon Losses							
Stoichiometric Hydrogen Demand	28	pounds					
DOC Released	176	pounds					
Pounds Hydrogen Produced per Pound Substrate	0.11	pounds H <sub>2</sub> /pound substrate					
Soybean Oil = 0.18							
Soybean Oil Emulsion Concentrate = 0.11							
Substrate Density	7.66	pounds substrate/gallon					
Soybean Oil = 7.7 lbs/gal							
Soybean Oil Emulsion Concentrate = 7.66 lbs/gal							
<b>Substrate Requirement Based on Stoichiometric Hydrogen Demand and Carbon Losses</b>							
	427	pounds					
	56	gallons					
Section G: Substrate Requirement Calculations Based on Adsorptive Capacity of Soil							
Adsorptive Capacity of Soil	0.0020	lbs oil/lbs soil					
Typical Values = 0.001 to 0.004							
Bulk density of soil	120	lbs/ft <sup>3</sup>					
Weight of sediment to be treated	300,000	lbs					
<b>Substrate Requirement Based on Adsorptive Capacity of Soil</b>							
	600	pounds					
	78	gallons					

Figure G.1 Example Spreadsheet for Edible Oil Substrate Calculations



**Figure G.2 Dimensions Used in Calculating a Treatment Zone**

**Section C: Design Lifespan for One Application**

The user enters a design lifespan which is used along with the data in Sections A and B to calculate the total volume of groundwater to be treated. When selecting a design life, users should be aware that the spreadsheets assume the barrier or source area treatment will operate at 100% efficiency until the day when the edible oil substrate runs out. On that day, the treatment efficiency is assumed to drop to zero.

However, in practice, treatment efficiency will begin to decline as substrate is depleted from the more permeable/contaminated zones, although remaining biomass may sustain bioactivity beyond depletion of the oil due to endogenous decay. Consequently, users should include an appropriate factor of safety when selecting the design life.

In addition, users should take into account project cost, contaminant source(s) and concentrations, and long term remedial objectives when selecting a design life. For long term biobarrier applications, a longer design life may be used with the assumption that additional edible oil substrate will need to be injected after oil from the initial injection is depleted.

**Section D: Electron Acceptors**

In this section the user enters concentrations of chlorinated aliphatic hydrocarbons (CAHs), other contaminants to be treated (*e.g.*, perchlorate), and native electron acceptors. The spreadsheet then calculates and sums the stoichiometric hydrogen demand for each constituent over the application design life. This hydrogen demand is used to determine the amount of edible oil substrate required for biological processes to deplete native electron acceptors and to degrade CAHs by anaerobic reductive dechlorination. The spreadsheet may be modified for other contaminants (*e.g.*, perchlorate) and degradation reactions.

For this example, data is entered for dissolved concentrations of dissolved oxygen (DO), nitrate, sulfate, CAHs, and perchlorate that will migrate through the treatment zone based on upgradient monitoring data. Note that this in this example, the mass of CAHs sorbed to the aquifer matrix or present in the form of a dense non-aqueous phase liquid (DNAPL) are not accounted for. This is not likely to be significant for a biobarrier of limited thickness across a dilute solute plume. However, the amount of CAH mass sorbed to the aquifer or present as a DNAPL should be accounted for in source area applications.

### **Section E: Additional Hydrogen Demand and Carbon Losses**

In this section the user estimates other demands on hydrogen that effect the total amount of substrate required. These include electron acceptor demand from iron reduction, manganese reduction, and methanogenesis. Concentrations of soluble iron (II), manganese (II), and methane that are anticipated to be generated are input by the user to determine the hydrogen demand. A typical range of concentrations is provided for guidance.

In addition, the user is asked to enter an estimate of the concentration of dissolved organic carbon (DOC) that will migrate out of the treatment zone before being utilized by biological activity. A typical range of concentrations of DOC from 60 to 100 milligrams per liter (mg/L) is provided for guidance. Note that concentrations of DOC within this range may sustain anaerobic degradation processes and effectively extend the treatment zone in a downgradient direction.

### **Section F: Substrate Requirement Based on Hydrogen Demand and Carbon Losses**

Section F summarizes and totals the stoichiometric hydrogen demand and the amount of DOC that will be released from the treatment zone. The spreadsheet then calculates the amount of edible oil substrate required to meet these two factors in terms of pounds and gallons of product based stoichiometric production of hydrogen from the oil and on the density and percent oil in the emulsion product. In this case 427 pounds, or 56 gallons, of emulsion product are calculated to meet the stoichiometric hydrogen demand and carbon losses.

Note that in this example the stoichiometric hydrogen demand is 28 pounds and the DOC released is 176 pounds. No design factor is applied, although the DOC released may be considered a safety factor in that it is not assumed to be used for anaerobic degradation processes. In reality the mass of DOC will ultimately be degraded and will likely support anaerobic degradation processes, even if this occurs downgradient of the designed treatment zone.

### **Section G: Substrate Requirement Based on Adsorptive Capacity of Soil**

In Section G the user is asked to enter a value for the adsorptive capacity of soil at the site in pounds of oil per pound of soil, with a range from 0.001 to 0.004 provided as typical values (see [Table 4.4](#) for supporting data). The spreadsheet then calculates the amount of substrate required to uniformly distribute the emulsified oil substrate throughout the targeted treatment zone based on the treatment zone dimensions, soil bulk density, and the oil retention factor entered for the aquifer material.



In this case, the substrate required based on the estimated adsorptive capacity of the aquifer material was calculated to be 600 pounds, or 78 gallons, of emulsion product. This is approximately 40 percent greater than the amount of substrate estimated from the sum of the stoichiometric hydrogen demand and carbon losses (427 pounds, or 56 gallons, of product). For the example illustrated here, the amount of edible oil recommended for effective treatment would be 600 pounds, or 78 gallons, of product to obtain a uniform distribution of edible oil substrate throughout the treatment zone.

In summary, this appendix illustrates a common method to estimate the amount of edible oil substrate to apply based on site-specific data. There is inherent uncertainty in estimating: 1) the additional hydrogen demand from iron reduction, manganese reduction, and methanogenesis; 2) the amount of DOC released; and 3) the adsorptive capacity of the soil matrix. Conservative estimates for these parameters should be used.

Caution is also advised in how much total substrate to apply in a single application, perhaps the case when using a design life in excess of 4 to 5 years. The injection of large quantities of edible oil may result in excessive production of metabolic acids, which could result in suppression of the groundwater pH and lowering of the effectiveness of dechlorinating bacteria to degrade CAHs. In some cases, amendments may be necessary to buffer groundwater pH to maintain effective anaerobic reductive dechlorination of CAHs.

**APPENDIX H**  
**EDIBLE OIL CASE HISTORIES**

## **APPENDIX H.1**

### **Cost and Performance Report**

**Enhanced *In Situ* Anaerobic Bioremediation of Chlorinated Solvents at the  
Hangar K Site, Cape Canaveral Air Force Station, Florida**

**FINAL**

**COST AND PERFORMANCE REPORT**

**ENHANCED *IN-SITU* ANAEROBIC BIOREMEDIATION OF  
CHLORINATED SOLVENTS AT THE HANGAR K SITE,  
CAPE CANAVERAL AIR FORCE STATION, FLORIDA**

**June 2007**

**Revision 4.0**



**Prepared for:**

**AIR FORCE CENTER FOR ENGINEERING AND THE ENVIRONMENT  
BROOKS CITY-BASE, TEXAS**

**Prepared by:**

**PARSONS**  
1700 Broadway, Suite 900  
Denver, Colorado 80290

## 1.0 INTRODUCTION

This report summarizes the cost and performance of a demonstration of enhanced *in situ* anaerobic bioremediation using vegetable oil at the Hangar K Site, located at Cape Canaveral Air Force Station (CCAFS), Florida. The demonstration was conducted by Parsons Infrastructure & Technology Group, Inc. (Parsons) as a case study in support of the Air Force Center for Engineering and the Environment (AFCEE) *Enhanced In Situ Bioremediation Initiative*. CCAFS is hosted by the 45<sup>th</sup> Space Wing, which facilitated site selection and implementation of this demonstration. Technology demonstration summary information is listed in Table 1.

**Table 1. Summary Information**

<b>Site Name, Location</b>	Hangar K, Cape Canaveral Air Force Station, Florida
<b>Treatment Mechanism</b>	Anaerobic Reductive Dechlorination
<b>Technology</b>	Enhanced Anaerobic Bioremediation using Vegetable Oil Substrate
<b>Configuration</b>	Direct Subsurface Injection
<b>Technology Scale</b>	Pilot (Phase I) and Expanded-Scale (Phase II)
<b>Media/Matrix Treated</b>	Groundwater
<b>Contaminants Targeted</b>	Chlorinated Ethenes (PCE, TCE, DCE, VC)
<b>Period of Operation</b>	Phase I – June 1999 to June 2000 Phase II – June 2000 to April 2006

## 2.0 SITE DESCRIPTION

Hangar K is located in the Industrial Area (Area 3A) at CCAFS, Florida. Hangar K was formerly operated as a missile assembly facility where launch support activities were performed. A variety of industrial chemicals were used in fabrication, maintenance, repair, painting, and machine parts cleaning operations conducted at Hangar K. The chlorinated solvents tetrachloroethene (PCE) and trichloroethene (TCE) were among the chemicals known to have been used and stored at the site. Accidental release of these compounds to the environment has resulted in contamination of the shallow unconfined aquifer beneath and downgradient from the release site (*i.e.*, the source area).

Chlorinated ethenes, consisting predominantly of TCE and its dechlorination products (dichloroethene [DCE] isomers and vinyl chloride [VC]), have dissolved into and migrated with groundwater to form a 160-acre groundwater contaminant plume. Two potential source areas have been identified at Hangar K. One of the source areas, east of Hangar K, was selected as the location for Phase I and Phase II of this enhanced *in situ* anaerobic bioremediation demonstration.

Chlorinated solvents are dense non-aqueous-phase liquids (DNAPLs) that migrate downward through unsaturated and saturated soils under the influence of gravity. Because DNAPLs are heavier than water, in sufficient mass, solvents will “sink” below the water table. In general, where concentrations of TCE in groundwater are greater than 10 percent of the compound’s solubility in water it may be inferred that TCE is present in the form of a dense non-aqueous phase liquid (DNAPL) (*e.g.*, Chapter 7 of Cohen and Mercer, 1993).

TCE has been detected at the Hangar K source area at concentrations approaching 30 percent of its aqueous solubility, suggesting that TCE is present in the subsurface at the Hangar K site as a DNAPL. This inference is further supported by the vertical distribution of chlorinated ethenes in the shallow aquifer at Hangar K, with the highest contaminant concentrations detected in the lower part of the aquifer.

Groundwater at the demonstration site is encountered at 4 to 6 feet below ground surface (bgs), and the affected aquifer is approximately 30 to 35 feet thick. The highest dissolved contaminant concentrations have been detected in groundwater at approximately 20 to 35 feet bgs. The contaminated horizon is predominately fine- to medium-grained sand, with lenses of silty sand and silty clay. The hydraulic conductivity of the formation has been calculated to be 100 to 300 feet per day (ft/day), with a hydraulic gradient of 0.0003 to 0.0005 foot per foot (ft/ft). The direction of groundwater flow in the immediate vicinity of the demonstration site is towards the north. Assuming an effective porosity of 25 percent, the rate of advective groundwater flow is estimated to range from 44 to 220 feet per year (ft/yr). Hydrogeologic and maximum pre-demonstration contaminant concentrations for the Hangar K site are summarized in Table 2.

**Table 2. Hydrogeologic and Contaminant Characteristics**

<b>Site Attribute</b>	<b>Description</b>
<b>Aquifer Matrix</b>	Sand, Silty Sand
<b>Depth to Groundwater</b>	4 to 6 feet below ground surface
<b>Thickness of Aquifer</b>	30 to 35 feet
<b>Hydraulic Conductivity</b>	100 to 300 feet per day (ft/day)
<b>Effective Porosity</b>	25 percent (estimated)
<b>Hydraulic Gradient</b>	0.0003 to 0.0005 foot per foot (ft/ft)
<b>Groundwater Velocity</b>	44 to 220 feet per year (ft/yr)
<b>Maximum Groundwater Contaminant Concentrations</b> <sup>a/</sup>	PCE – 140 micrograms per liter (µg/L) TCE – 300,000 µg/L <i>cis</i> -1,2-DCE – 120,000 µg/L VC – 550 µg/L
<b>DNAPL Presence</b>	Probable - dissolved TCE up to 30 milligrams per liter (mg/L)
<b>Fraction Organic Carbon</b>	Not Available

<sup>a/</sup> Pre-Phase II injection concentrations at upgradient well HRGK-VEG1.

### **3.0 TECHNOLOGY DESCRIPTION**

Chlorinated solvents, also referred to as chlorinated aliphatic hydrocarbons (CAHs), can be transformed, directly or indirectly, by biological processes. Under anaerobic conditions, biodegradation of chlorinated solvents may proceed through the process of reductive dechlorination. During reductive dechlorination, the chlorinated hydrocarbon is used as an electron acceptor, and a chloride atom is removed and replaced with a hydrogen atom. Biologically mediated reductive dechlorination generally occurs sequentially. For the chlorinated ethenes, dechlorination progresses from PCE to TCE to isomers of DCE to VC to ethene. Ethene may be further reduced to ethane.

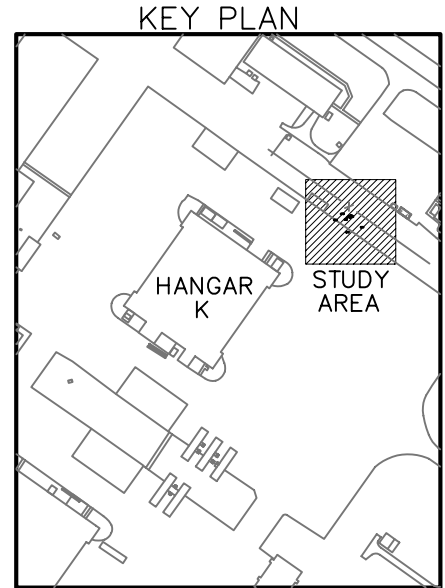
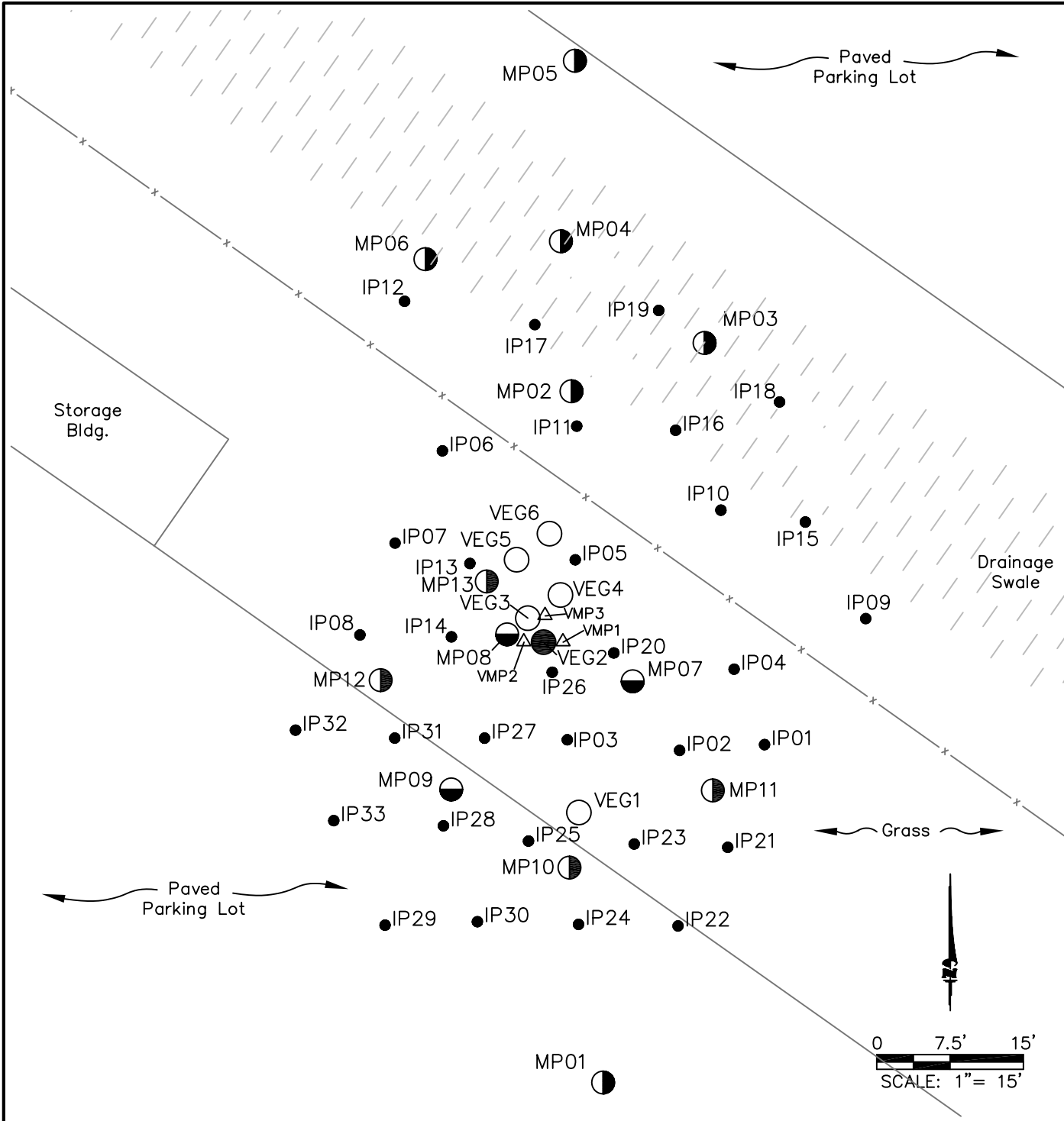
Limited reductive dechlorination has been demonstrated under nitrate- and iron-reducing conditions, but the most rapid biodegradation rates, affecting the widest range of CAHs, occur under sulfate-reducing and methanogenic conditions (Bouwer, 1994). Because CAH compounds are used as electron acceptors, there must be an appropriate source of organic carbon (electron donor) to fuel microbial growth in order for reductive dechlorination to occur. The distribution of CAHs in groundwater at the Hangar K Site suggests that the natural biodegradation of PCE and TCE at the Hangar K Site is not complete, and may be electron-donor limited. Thus, Hangar K was a suitable demonstration site to determine if the addition of an organic substrate could enhance rates of anaerobic reductive dechlorination of CAHs. Food-grade soybean oil was used to remediate the CAH plume at this site by overcoming the inferred substrate limitation.

Vegetable oil is an inexpensive, food-grade carbon source. The separate phase nature and low solubility of vegetable oil allows for its slow dissolution into groundwater, although it may be readily consumed by microbial activity (Parsons, 2004). One objective of this demonstration was to determine whether a single, low-cost injection of neat vegetable oil could provide sufficient substrate to enhance reductive dechlorination rates in the aquifer for 3 years or more.

Another objective of this demonstration was to evaluate the effects on contaminant mass due to CAH sequestration into the vegetable oil. Chlorinated ethenes have varying affinities for partitioning from the aqueous, sorbed, and/or free (DNAPL) phases into vegetable oil (Pfeiffer *et al.*, 2005). This affinity temporarily sequesters the CAHs in the vegetable oil, reducing the mass available for dissolution into and transport with groundwater. If separate-phase vegetable oil remains in place within the treatment zone, the mass flux of CAHs out of the source area will be reduced. Ultimately, the partitioned contaminant mass is released back into the aqueous phase as the oil is degraded, into an anaerobic environment optimal for reductive dechlorination to occur.

### **4.0 TECHNOLOGY IMPLEMENTATION**

Vegetable oil was injected into the subsurface at the Hangar K Site to create the reduction/oxidation (redox) and electron donor conditions necessary to promote the microbial reductive dechlorination of CAHs in groundwater. The Phase I pilot test was conducted from June 1999 to December 1999 within the source area. The pilot study included the installation one injection well (HGRK-VEG2), four observation wells downgradient of the injection well (HRGK-VEG3 through HRGK-VEG6), and one upgradient well (HRGK-VEG1) for use as a background location (Figure 1). All Phase I wells were screened from 32 to 33 feet bgs, the targeted contaminant zone.



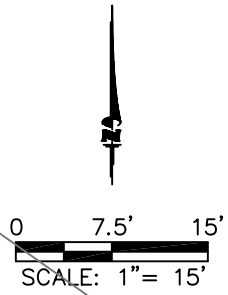
**LEGEND**

- VEGx ● 2" PHASE I INTERMEDIATE DEPTH MONITORING POINT
- VEGx ○ 2" PHASE I INTERMEDIATE DEPTH MONITORING POINT
- MP0x ● 3/4" PHASE II INTERMEDIATE DEPTH MONITORING POINT
- MP0x ○ 3/4" PHASE II SHALLOW DEPTH MONITORING POINT
- IP0x ● 3/4" PHASE II INJECTION POINT
- VMPx △ VAPOR MONITORING POINT
- x — FENCELINE
- /// DRAINAGE SWALE

**FIGURE 1**  
**PHASE II**  
**INJECTION SITE PLAN**

Hangar K  
 CCAFS, Florida

**PARSONS**  
 Denver, Colorado





Approximately 110 gallons of food-grade soybean oil was injected into the contaminated aquifer through injection well HGRK-VEG2 in June 1999. The injection took place over approximately 5 hours, at a flow rate averaging 0.36 gallons per minute (gpm) and with back pressure at the well head ranging from 20 to 32 pounds per square inch (psi). Immediately following the injection, groundwater and mobile vegetable oil were extracted (pumped) back out of the injection well using a pneumatic diaphragm pump until additional oil could not be extracted. Periodic recovery of free oil continued over the next 3 weeks using a peristaltic pump until approximately 62 gallons of oil had been recovered and approximately 48 gallons of oil remained in the aquifer.

This was done to leave the oil in a residual (non-mobile) phase, and to reduce the effect of the oil to plug the formation and inhibit groundwater flow. The monitoring network was then sampled monthly for 6 months following the injection (from July through December 1999), and the groundwater samples were analyzed for chlorinated ethenes (Table 3) and geochemical indicators of biodegradation (Table 4).

Phase II was initiated in 2000 as an expanded-scale demonstration of *in situ* source zone treatment. In June 2000, 33 injection points (screened from approximately 22 to 32 feet bgs) and 9 groundwater monitoring points were installed in the suspected Hangar K source area, using a cone-penetrometer technology (CPT) rig (Figure 1). Groundwater samples were collected from the Phase II monitoring points and one Phase I monitoring point (HGRK-VEG4) in July 2000 to establish baseline conditions for the Phase II demonstration.

In August 2000, 55 gallons of pure soybean oil was injected into each injection point, followed by a 200-gallon native groundwater push (obtained from a nearby monitoring well) to help distribute the oil into the formation. A total of 1,815 gallons (13,200 pounds) of soybean oil was injected into the 33 injection points. The maximum flow rate for injection of the oil was 9.2 gpm, and the maximum injection pressure used was 28 psi. The time for injection of the oil and water push for all 33 points took approximately two weeks.

The first round of post-injection groundwater sampling was conducted in February and March 2001, 6 months after the Phase II injection. Four additional/replacement groundwater monitoring points (HGRK-MP10 through HGRK-MP13) were installed using a Geoprobe<sup>®</sup> rig in April 2002; and performance monitoring of the Phase II monitoring network was conducted in April and October 2002, and April and December 2003. An additional monitoring event was conducted in April 2006 (68 months after injection) to evaluate depletion of the substrate, potential rebound in geochemical conditions or contaminant concentrations, as well as the long-term performance of the demonstration.

## **5.0 TECHNOLOGY PERFORMANCE**

### **5.1 Phase I Pilot Test**

Results of the Phase I pilot test demonstrated that the addition of vegetable oil stimulated reductive dechlorination of TCE, and that the injection of vegetable oil appeared to have a strong physical effect (*i.e.*, sequestration) on the fate and transport of chlorinated ethenes. At the injection well, dissolved concentrations of TCE and its dechlorination products decreased by up to three orders of magnitude within the first month following injection of the vegetable oil, presumably as a result of partitioning of the contaminants into the oil.

**Table 3. Groundwater Geochemical Data**

Sample Location	Sample Date	Months from Injection	pH	Dissolved Oxygen (mg/L) <sup>a/</sup>	Redox Potential (millivolts)	Manganese, Total (mg/L)	Ferrous Iron (mg/L)	Sulfate (mg/L)	Total				
									Organic Carbon (mg/L)	Methane (mg/L)	Ethane (µg/L) <sup>b/</sup>	Ethene (µg/L)	Hydrogen (nM) <sup>c/</sup>
HGRK-VEG1	11-Jul-00	0	7.09	<0.1	-143	<0.1	3.32	17	32	0.21	1.1	28	--
	28-Feb-01	7	7.04	0.09	-191	<0.1	3.19	2.9	6.2	0.24	0.54	31	--
	5-Apr-06	68	6.41	0.2	-132	12.4	18.7	<5.0	4.6J	13.0	0.64	15,000	--
HGRK-VEG3	10-Jul-00	0	6.60	<0.1	-145	<0.1	75.1	2.29	79	--	--	--	--
	3-Dec-03	40	6.30	2.56	-155	1.4	20.4	0.85J	20	9.0	0.12	4,000	3.9
	5-Apr-06	68	6.23	0.17	-130	16.6	25.4	<5.0	8.0	18.0	0.74	2,900	--
HGRK-VEG4	11-Jul-00	0	6.88	<0.1	-141	<0.1	3.04	23	54	--	--	--	--
	25-Apr-02	20	6.31	0.13	-173	10.5	8.1	<1.0	420	3.5	3.9	10,000	8.5
	15-Oct-02	26	7.30	0.07	-109	0.94	8.28	<1.0	310	8.0	3.9	14,000	16
	23-Apr-03	32	6.36	0.30	-160	12.1	15.12	<1.0	45	18	1.2	6,200	2.2
HGRK-MP01	17-Jul-00	0	7.14	<0.1	-133	<0.1	1.96	19.21	31	0.290	34.679	113	--
	28-Feb-01	7	7.30	0.19	-131	<0.1	1.93	29	2.9	0.380	1.600	36.0	--
	24-Apr-02	20	7.13	0.31	-139	0.3	1.44	15	5.3	0.260	0.410	35.0	0.73
	14-Oct-02	26	8.00	0.13	-123	0.01	0.94	15	18	0.380	0.500	31.0	5.2
	22-Apr-03	32	7.13	0.30	-128	<0.1	1.81	15	<5.0	0.350	0.400	34.0	1.9
	3-Dec-03	40	6.93	2.95	-153	<0.1	2.45	14	4.8J	0.052	0.082	7.2	1.6
	6-Apr-06	68	7.12	0.25	-152	<0.1	0.80	19	3.0J	0.360	1.200	44.0	--
HGRK-MP02	18-Jul-00	0	6.05	<0.1	-157	<0.1	2.2	39.4	11	0.139	13.195	55	--
	1-Mar-01	7	6.11	0.16	-219	<0.1	83	<0.1	1,000	8.70	0.390	380	--
	24-Apr-02	20	6.42	0.14	-105	8.2	4.02	<1.0	37	13.0	0.830	3,700	3.0
	16-Oct-02	26	6.98	0.12	-99	0.72	12.66	3.8	11	14.0	1.300	7,400	4.7
	22-Apr-03	32	6.48	0.34	-108	13.4	17.88	<1.0	16	17.0	1.100	3,300	--
	4-Dec-03	40	6.47	2.86	-158	2.9	8.15	1.0J	8.2	9.5	0.330	2,100	3.3
	4-Apr-06	68	6.60	0.18	-117	10.5	20.4	<5.0	2.4J	22.0	0.670	3,000	--
HGRK-MP03	12-Jul-00	0	7.35	<0.1	-141	<0.1	1.31	44.2	13	0.051	6.591	20	--
	1-Mar-01	7	6.74	0.12	-238	<0.1	15	<0.1	NA	11.0	0.430	690	--
	23-Apr-02	20	6.49	0.13	-123	0.5	11.3	5.4	11	17.0	0.410	2,200	--
	16-Oct-02	26	7.02	<0.1	-107	0.66	12.78	4.2	<5.0	14.0	0.350	3,300	--
	22-Apr-03	32	6.49	0.17	-115	0.3	18.81	<1.0	5.8	18.0	0.400	1,900	--
	4-Dec-03	40	6.50	3.31	-140	12.3	12.15	1.2	5.3	14.0	0.290	2,400	--
	4-Apr-06	68	6.61	0.21	-116	12.2	20.5	<5.0	1.8J	23.0	0.680	1,500	--
HGRK-MP04	12-Jul-00	0	7.27	<0.1	-145	<0.1	1.36	45.7	8.4	0.043	2.148	9	--
	1-Mar-01	7	6.80	0.15	-246	<0.1	7.7	<0.1	NA	15.0	0.800	780	--
	24-Apr-02	20	6.53	0.25	-116	10.4	0.87	<1.0	6.6	20.0	<0.005	1,300	2.0
	16-Oct-02	26	7.09	<0.1	-114	0.52	19.86	4.2	<5.0	18.0	0.170	1,600	4.7
	22-Apr-03	32	6.52	0.18	-117	12.4	16.48	<1.0	<5.0	18.0	0.220	1,800	1.8
	4-Dec-03	40	6.54	3.11	-147	1.4	15.9	1.1	4.1J	12.0	0.033	1,400	3.2
	4-Apr-06	68	6.63	0.27	-124	11.8	21.8	<5.0	2.9J	18.0	0.470	2,100	--

(Continued)

**Table 3. Groundwater Geochemical Data (Concluded)**

Sample Location	Sample Date	Months from Injection	pH	Dissolved Oxygen (mg/L) <sup>a/</sup>	Redox Potential (millivolts)	Manganese, Total (mg/L)	Ferrous Iron (mg/L)	Sulfate (mg/L)	Total Organic					Hydrogen (nM) <sup>c/</sup>
									Carbon (mg/L)	Methane (mg/L)	Ethane (µg/L) <sup>b/</sup>	Ethene (µg/L)		
HGRK-MP05	13-Jul-00	0	7.14	1.43	-127	<0.1	2.05	30	12	0.153	9.745	39	--	
	1-Mar-01	7	7.09	0.15	-146	<0.1	2.07	38	NA	0.260	0.20	18	--	
	24-Apr-02	20	6.66	0.53	-124	1.4	0.65	18	<5.0	3.60	0.12	600	0.84	
	16-Oct-02	26	7.49	<0.1	-124	0.03	5.08	13	<5.0	9.3	0.17	1,700	4.6	
	21-Apr-03	32	6.72	0.26	-99	2.3	5.96	11	<5.0	12.0	0.26	1,300	1.4	
	4-Dec-03	40	6.70	3.07	-129	0.7	11.85	6.3	4.5J	7.7	0.007	700	0.86	
HGRK-MP07	17-Jul-00	0	7.07	<0.1	-59	<0.1	0.89	31	<5.0	--	--	--	--	
	28-Feb-01	7	7.24	0.1	--	<0.1	0.69	33	--	2.7	0.24	2.6	--	
	24-Apr-02	20	5.98	0.17	-117	13.2	30.7	9.3	900	5.0	2.2	2,200	6.8	
	17-Oct-02	26	7.37	<0.1	-125	0.03	0.93	11	--	1.9	0.038	9.8	4.5	
	23-Apr-03	32	7.05	0.31	-72	<0.1	0.59	16	<5.0	0.520	0.028	7.2	1.3	
	2-Dec-03	40	6.88	0.86	-100	0.5	0.51	9.6	1.3J	0.035	0.003J	0.056	1.1	
	6-Apr-06	68	7.14	0.24	-46	<0.1	<0.01	7.8	2.7J	0.650	0.014J	11.0	--	
HGRK-MP08	17-Jul-00	0	7.13	<0.1	-123	<0.1	2.5	40	19	--	--	--	--	
	28-Feb-01	7	7.24	0.12	-236	<0.1	2.63	<0.1	--	6.5	0.18	6.7	--	
	14-Oct-02	26	7.34	<0.1	-149	0.01	2.52	9.6	<5.0	7.7	0.11	12	--	
	23-Apr-03	32	6.95	0.37	-148	<0.1	3.52	10	5.1	6.5	0.15	11	--	
	2-Dec-03	40	6.85	1.85	-160	<0.1	2.3	5.9	2.2J	7.1	0.52	21	--	
HGRK-MP10	25-Apr-02	20	6.15	0.15	-107	<0.1	27.72	<1.0	430	5.00	11.0	9,400	--	
	22-Apr-03	32	6.40	0.14	-91	4.8	27.52	<1.0	240	12.0	1.0	7,400	1.3	
	3-Dec-03	40	6.37	2.65	-149	2.4	28.71	0.85J	160	18.0	1.8	10,000	--	
	6-Apr-06	68	6.52	0.15	-141	6.0	10.3	4.1J	2.4J	21.0	1.5	11,000	--	
HGRK-MP11	25-Apr-02	20	6.49	0.03	-148	8.2	16.45	10	86	10.0	8.3	3,000	--	
	17-Oct-02	26	6.96	0.09	-113	0.1	15.66	4.6	18	15.0	0.48	12,000	--	
	23-Apr-03	32	6.53	0.32	-98	1.1	13.35	<1.0	12	18.0	0.45	8,000	--	
	1-Dec-03	40	6.38	0.98	-119	1.5	12.05	3.4	3.9J	21.0	0.40	9,600	--	
	4-Apr-06	68	6.73	0.21	-132	8.7	15	<5.0	1.8J	22.0	0.34	6,000	--	
HGRK-MP12	25-Apr-02	20	6.38	0.06	-101	12.3	19.05	<1.0	170	12.0	11.0	2,700	--	
	15-Oct-02	26	7.39	0.02	-107	<0.1	16.92	<1.0	31	17.0	0.38	2,300	--	
	23-Apr-03	32	6.32	0.25	-84	14.7	16.66	4.6	8.8	18.0	0.89	2,000	--	
	1-Dec-03	40	6.29	0.96	-112	12.8	21.28	1.0J	6.0	16.0	0.78	2,800	--	
	4-Apr-06	68	6.65	0.29	-133	13.3	15.2	<5.0	2.0J	23.0	0.76	1,200	--	
HGRK-MP13	25-Apr-02	20	6.36	0.02	-69	<0.1	16.45	<1.0	240	7.5	7.400	4,400	--	
	15-Oct-02	26	7.24	0.05	-102	0.09	21.6	<1.0	16	14.0	0.55	2,800	--	
	23-Apr-03	32	6.36	0.27	-90	12.7	19.2	4.0	9.6	17.0	0.54	>1500	--	
	2-Dec-03	40	6.32	0.90	-118	0.9	16.15	1.6	4.8J	17.0	0.82	5,400	--	
	4-Apr-06	68	6.68	2.80	-128	11.3	18.3	<5.0	1.9J	21.0	0.77	1,900	--	

<sup>a/</sup> mg/L = milligrams per liter.

<sup>b/</sup> µg/L = micrograms per liter.

<sup>c/</sup> nM = nanomolar.

**Table 4. Summary of Chlorinated Ethenes in Groundwater**

Screened Interval	Months from Phase II	PCE <sup>b/</sup>	TCE <sup>b/</sup>	1,1-DCE <sup>b/</sup>	<i>cis</i> -1,2-DCE	<i>trans</i> -1,2-DCE	Vinyl Chloride		
Sampling Location (ft bgs) <sup>a/</sup>	Sample Date	Injection	(µg/L) <sup>c/</sup>	(µg/L)	(G68g/L)	(µg/L)	(µg/L)	(µg/L)	
HGRK-VEG1	32-33'	11-Jul-00	0	<b>140</b>	<b>300,000</b>	<b>390</b>	<b>120,000</b>	<b>1,400</b>	<b>550</b>
		28-Feb-01	7	<b>48</b>	<b>310,000</b>	<b>200</b>	<b>110,000</b>	<b>1,600</b>	<b>1,200</b>
		5-Apr-06	68	<1,000	<1,000	<1,000	<b>8,580</b>	<b>1,650</b>	<b>19,600</b>
HGRK-VEG3	32-33'	10-Jul-00	0	<b>2.6J</b>	<b>66,000</b>	<b>450</b>	<b>120,000</b>	<b>1,800J</b>	<b>47,000</b>
		3-Dec-03	40	<1.4	<b>0.31J</b>	<1.2	<b>1.1J</b>	<b>7.6</b>	<b>6.4</b>
		5-Apr-06	68	<1.0	<b>0.29J</b>	<1.0	<b>0.31J</b>	<b>0.60J</b>	<b>1.4</b>
HGRK-VEG4	32-33'	11-Jul-00	0	<5.0	<b>33,000</b>	<b>800</b>	<b>170,000</b>	<b>1,800J</b>	<b>38,000</b>
		25-Apr-02	20	<14	<10	<12	<b>21</b>	<b>39</b>	<b>7,200</b>
		15-Oct-02	26	<3.5	<b>0.46J<sup>d/</sup></b>	<3.0	<b>2.1J</b>	<b>2.5</b>	<b>1,300</b>
		23-Apr-03	32	<1.4	<1.0	<1.2	<b>0.99J</b>	<b>0.60</b>	<b>190</b>
HGRK-MP01 (Upgradient)	24'-34'	17-Jul-00	0	<b>28</b>	<b>49,000</b>	<b>36</b>	<b>19,000</b>	<b>220</b>	<b>140</b>
		28-Feb-01	7	<b>11</b>	<b>120,000</b>	<b>140</b>	<b>90,000</b>	<b>1,100</b>	<b>1,000</b>
		24-Apr-02	20	< <b>280</b>	<b>120,000</b>	<b>200J</b>	<b>74,000</b>	<b>1,200</b>	<b>660</b>
		14-Oct-02	26	<280	<b>130,000</b>	<b>210J</b>	<b>71,000</b>	<b>1,100</b>	<b>630</b>
		22-Apr-03	32	<280	<b>110,000</b>	<b>160J</b>	<b>66,000</b>	<b>1,000</b>	<b>670</b>
		3-Dec-03	40	<470	<b>110,000</b>	<b>190J</b>	<b>74,000</b>	<b>1,300</b>	<b>850</b>
		6-Apr-06	68	<5,000	<b>103,000</b>	<5,000	<b>60,800</b>	<b>900J</b>	<5,000
HGRK-MP02	22.5'-32.5'	18-Jul-00	0	<b>3.5J</b>	<b>77,000</b>	<b>76</b>	<b>25,000</b>	<b>600</b>	<b>170</b>
		1-Mar-01	7	<5.0	<b>180</b>	<5.0	<b>69</b>	<b>5.7</b>	<b>1,500</b>
		24-Apr-02	20	<14	<10	<b>22</b>	<b>4,300</b>	<b>150</b>	<b>3,700</b>
		16-Oct-02	26	<560	<400	<b>49J</b>	<b>11,000</b>	<b>310</b>	<b>6,800</b>
		22-Apr-03	32	<2.8	<2.0	<b>0.26J</b>	<b>87</b>	<b>16</b>	<b>890</b>
		4-Dec-03	40	<1.4	<1.0	<1.2	<b>0.40J</b>	<b>0.66</b>	<b>76</b>
		4-Apr-06	68	<1.0	<b>0.11J</b>	<1.0	<1.0	<b>0.13J</b>	<b>0.67J</b>
HGRK-MP03	21'-31'	12-Jul-00	0	<5.0	<b>21,000</b>	<b>29</b>	<b>12,000</b>	<b>540</b>	<b>41</b>
		1-Mar-01	7	<5.0	<b>2,500</b>	<b>48</b>	<b>14,000</b>	<b>230</b>	<b>12,000</b>
		23-Apr-02	20	<1.4	<b>0.45J</b>	<b>0.20</b>	<b>81</b>	<b>12</b>	<b>800</b>
		16-Oct-02	26	<35	<b>1.2J</b>	<b>20J</b>	<b>6,800</b>	<b>410</b>	<b>4,400</b>
		22-Apr-03	32	<7.0	<5.0	<b>0.74J</b>	<b>360</b>	<b>46</b>	<b>2,000</b>
		4-Dec-03	40	<1.4	<1.0	<1.2	<b>5.9</b>	<b>15</b>	<b>1,000</b>
		4-Apr-06	68	<1.0	<b>0.20J</b>	<1.0	<b>0.36J</b>	<b>0.23J</b>	<b>0.45J</b>
HGRK-MP04 (Downgradient)	21'-31'	12-Jul-00	0	<5.0	<b>24,000</b>	<b>31</b>	<b>7,300</b>	<b>440</b>	<b>52</b>
		1-Mar-01	7	<5.0	<b>1,200</b>	<b>32</b>	<b>10,000</b>	<b>300</b>	<b>4,800</b>
		24-Apr-02	20	<1.4	<b>19</b>	<b>0.11J</b>	<b>15</b>	<b>2.1</b>	<b>140</b>
		16-Oct-02	26	<1.4	<b>120</b>	<b>0.40J</b>	<b>57</b>	<b>3.3</b>	<b>45</b>
		22-Apr-03	32	<1.4	<b>0.16J</b>	<b>0.048J</b>	<1.2	<b>0.028J</b>	<b>3.3</b>
		4-Dec-03	40	<1.4	<b>0.064J</b>	<1.2	<b>0.18J</b>	<b>0.42J</b>	<b>0.68J</b>
		4-Apr-06	68	<1.0	<1.0	<1.0	<b>0.12J</b>	<1.0	<b>0.37J</b>

(continued)

**Table 4. Summary of Chlorinated Ethenes in Groundwater (Concluded)**

Sampling Location	Screened Interval (ft bgs) <sup>a/</sup>	Sample Date	Months from Phase II Injection	PCE <sup>b/</sup> (µg/L) <sup>c/</sup>	TCE <sup>b/</sup> (µg/L)	1,1-DCE <sup>b/</sup> (G68g/L)	<i>cis</i> -1,2-DCE (µg/L)	<i>trans</i> -1,2-DCE (µg/L)	Vinyl Chloride (µg/L)
HGRK-MP05 (Downgradient)	26'-36'	13-Jul-00	0	<5.0	<b>48,000</b>	<b>70</b>	<b>18,000</b>	<b>810</b>	<b>130</b>
		1-Mar-01	7	<5.0	<b>52,000</b>	<b>130</b>	<b>23,000</b>	<b>1,300</b>	<b>170</b>
		24-Apr-02	20	<140	<b>41,000</b>	<b>120</b>	<b>30,000</b>	<b>960</b>	<b>3,200</b>
		16-Oct-02	26	<190	<b>33,000</b>	<b>120J</b>	<b>28,000</b>	<b>1,100</b>	<b>6,100</b>
		21-Apr-03	32	<70	<b>27,000</b>	<b>74</b>	<b>20,000</b>	<b>770</b>	<b>3,500</b>
		4-Dec-03	40	<93	<b>10,000</b>	<b>44J</b>	<b>9,700</b>	<b>310</b>	<b>3,300</b>
HGRK-MP07	3'-13'	17-Jul-00	0	<b>1.0J</b>	<b>140</b>	<5.0	<b>190</b>	<b>2.7J</b>	<b>1.1J</b>
		28-Feb-01	7	<b>9.3</b>	<50	<5.0	<b>240</b>	<b>9.5</b>	<5.0
		24-Apr-02	20	<14	<b>53</b>	<b>3.7J</b>	<b>3,800</b>	<b>27</b>	<b>1,200</b>
		17-Oct-02	26	<b>0.058J</b>	<b>0.34J</b>	<b>0.056J</b>	<b>4.3</b>	<b>0.28J</b>	<b>0.77J</b>
		23-Apr-03	32	<1.4	<b>0.039J</b>	<1.2	<b>0.14J</b>	<0.60	<1.1
		2-Dec-03	40	<1.4	<1.0	<1.2	<b>0.49J</b>	<0.60	<1.1
		6-Apr-06	68	<1.0	<1.0	<1.0	<1.0	<1.0	
HGRK-MP08	3'-13'	17-Jul-00	0	<5.0	<b>110</b>	<5.0	<b>48</b>	<b>1.0J</b>	<5.0
		28-Feb-01	7	<5.0	<50	<5.0	<b>66</b>	<b>6.0</b>	<b>7.4</b>
		17-Oct-02	26	<1.4	<b>0.30J</b>	<b>0.066J</b>	<b>8.2</b>	<b>0.98</b>	<b>1.9</b>
		23-Apr-03	32	<1.4	<b>0.36J</b>	<1.2	<b>2.7</b>	<b>0.53J</b>	<b>0.46J</b>
		2-Dec-03	40	<1.4	<1.0	<1.2	<b>2.0</b>	<b>0.42J</b>	<b>0.42J</b>
HGRK-MP10	23'-33'	25-Apr-02	20	<7.0	<b>0.48J</b>	<6.0	<b>260</b>	<b>39</b>	<b>2,500</b>
		22-Apr-03	32	<14	<b>0.31J</b>	<b>5.3J</b>	<b>2,700</b>	<b>210</b>	<b>5,400</b>
		3-Dec-03	40	<14	<b>0.91J</b>	<b>4.0J</b>	<b>2,900</b>	<b>420</b>	<b>3,900</b>
		6-Apr-06	68	<2,000	<b>15,500</b>	<b>240J</b>	<b>53,400</b>	<b>5,220</b>	<b>10,400</b>
HGRK-MP11	23'-33'	25-Apr-02	20	<140	<b>2,400</b>	<b>140</b>	<b>53,000</b>	<b>870</b>	<b>13,000</b>
		17-Oct-02	26	<350	<b>18J</b>	<b>140J</b>	<b>57,000</b>	<b>1,200</b>	<b>25,000</b>
		23-Apr-03	32	<70	<50	<b>21J</b>	<b>11,000</b>	<b>430</b>	<b>28,000</b>
		1-Dec-03	40	<4.7	<b>0.46J</b>	<b>2.5J</b>	<b>1,700</b>	<b>120</b>	<b>3,200</b>
		4-Apr-06	68	<1.0	<b>1.4</b>	<b>11</b>	<b>5,720</b>	<b>535</b>	<b>6,290</b>
HGRK-MP12	23'-33'	25-Apr-02	20	<1.4	<b>1.8</b>	<1.2	<b>2.2</b>	<b>0.61</b>	<b>100</b>
		15-Oct-02	26	<1.4	<b>0.28J</b>	<1.2	<b>1.9</b>	<b>1.2</b>	<b>99</b>
		23-Apr-03	32	<1.4	<1.0	<1.2	<b>0.28J</b>	<b>0.43J</b>	<b>6.9</b>
		1-Dec-03	40	<1.4	<1.0	<1.2	<1.2	<b>0.43J</b>	<b>1.3</b>
		4-Apr-06	68	<1.0	<1.0	<1.0	<1.0	<b>0.45J</b>	<b>0.91J</b>
HGRK-MP13	23'-33'	25-Apr-02	20	<14	<b>0.54J</b>	<b>17</b>	<b>5,800</b>	<b>280</b>	<b>8,800</b>
		15-Oct-02	26	<1.4	<b>0.57J</b>	<1.2	<b>1.0J</b>	<b>1.4</b>	<b>5.0</b>
		23-Apr-03	32	<1.4	<b>0.15J</b>	<1.2	<b>0.54J</b>	<b>0.37J</b>	<b>210</b>
		2-Dec-03	40	<1.4	<1.0	<1.2	<1.2	<b>0.13J</b>	<b>0.81J</b>
		4-Apr-06	68	<1.0	<b>0.17J</b>	<1.0	<b>5.4</b>	<b>5.4</b>	<b>22</b>

<sup>a/</sup> ft bgs = feet below ground surface.

<sup>b/</sup> PCE = tetrachloroethene; TCE = trichloroethene; DCE = dichloroethene.

<sup>c/</sup> µg/L = micrograms per liter.

<sup>d/</sup> J = estimated value.

Monitoring results for Phase I injection well HGRK-VEG2 showed that concentrations of TCE decreased from an initial (pre-injection) concentration of 100,000 micrograms per liter ( $\mu\text{g/L}$ ) to 110  $\mu\text{g/L}$  approximately 1 month after injection (Parsons, 2002). Similarly, concentrations of *cis*-1,2-DCE decreased from 48,000  $\mu\text{g/L}$  to 180  $\mu\text{g/L}$ , and concentrations of VC decreased from 330  $\mu\text{g/L}$  to less than 1.0  $\mu\text{g/L}$ , during the same 1-month interval. Concentrations of TCE in groundwater at the injection well location remained relatively low (<230  $\mu\text{g/L}$ ) for the remainder of the Phase I test, while concentrations of *cis*-1,2-DCE increased over time in the study area.

While the immediate decreases in contaminant concentrations at the injection well were likely due to initial partitioning into the vegetable oil, both the production of *cis*-1,2-DCE and the groundwater geochemical parameters measured during the pilot test provided evidence of strongly anaerobic conditions and limited reductive dechlorination in the pilot test reaction zone. Results of the Phase I pilot test also suggested that the vegetable oil was consumed fairly rapidly, and that the effects of enhanced biodegradation slowed at approximately 6 months.

## **5.2 Phase II Expanded Field Test**

### **5.2.1 Geochemistry**

Based on data collected from upgradient wells during the Phase II baseline sampling event (Table 3), groundwater in the Hangar K study area is naturally anaerobic due to the presence of natural organic carbon in the formation, with background concentrations of total organic carbon (TOC) typically between 10 and 20 milligrams per liter (mg/L); TOC concentrations greater than 20 mg/L are considered conducive to reductive dechlorination. Background concentrations of dissolved oxygen (DO) are less than 0.5 mg/L.

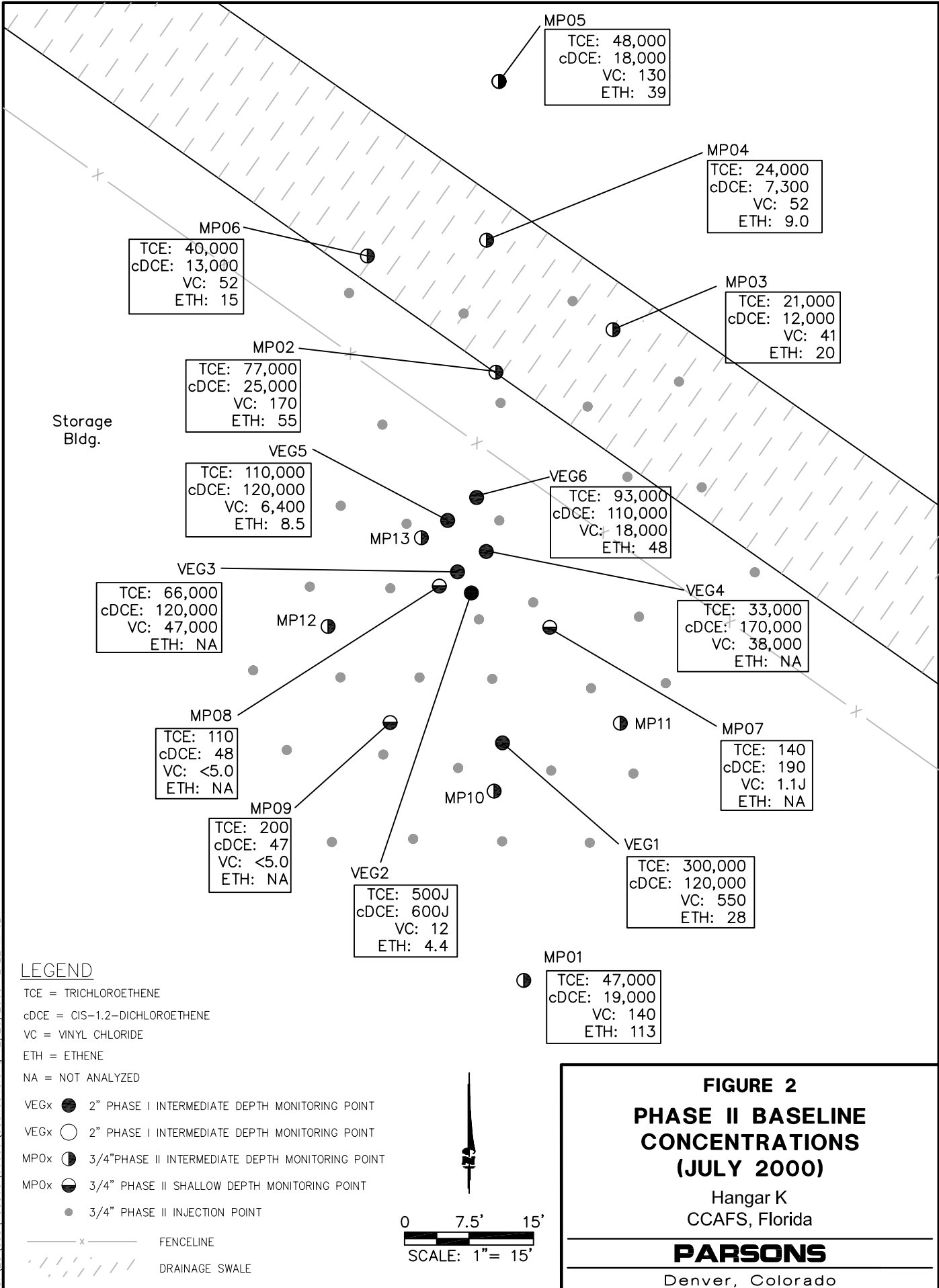
Addition of vegetable oil lowered the reducing environment at the site, with measurements of oxidation-reduction potential (ORP) ranging from -35 to -157 millivolts (mV) before the Phase II injection of vegetable oil, and from -100 to -250 mV after injection. Following the Phase II injection, concentrations of manganese and ferrous iron increased, concentrations of sulfate decreased, and concentrations of methane increased within the treatment zone. This indicates that the redox conditions achieved support the biological processes of manganese reduction, iron reduction, sulfate reduction, and methanogenesis. The redox conditions observed are also optimal for reductive dechlorination to occur.

TOC was depleted in April 2006 (68 months after injection) with concentrations below 10 mg/L at all sample locations. However, geochemical conditions remained strongly anaerobic with ORP ranging from -46 to -152 mV and methane ranging from 13 to 22 mg/L for wells screened across the injection horizon. While the vegetable oil substrate has been depleted, the groundwater geochemistry has not returned to background conditions.

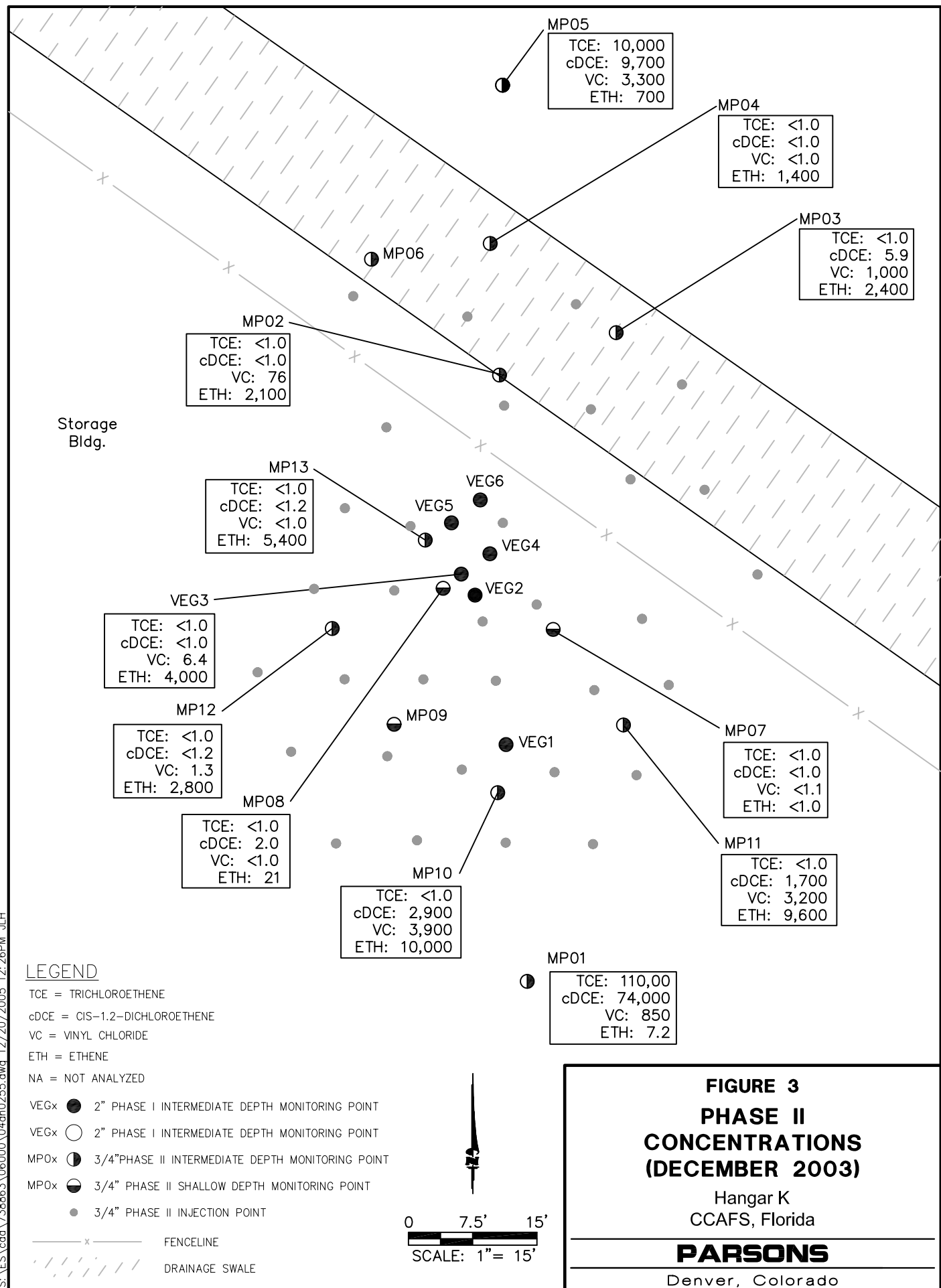
### **5.2.2 Chlorinated Ethenes in Groundwater**

Concentrations of chlorinated ethenes in groundwater at the Phase II monitoring locations are listed in Table 4. Concentrations of TCE at all of the Phase II monitoring points within the vegetable oil treatment zone decreased substantially from July 2000 (Figure 2) through December 2003 (Figure 3), following substrate injection in August 2000. Concentrations of TCE remained low through April 2006 (Figure 4), with a notable exception at sample location

S:\ES\cad\738863\06000\05dm0345.dwg 12/20/2005 12:22PM JLH

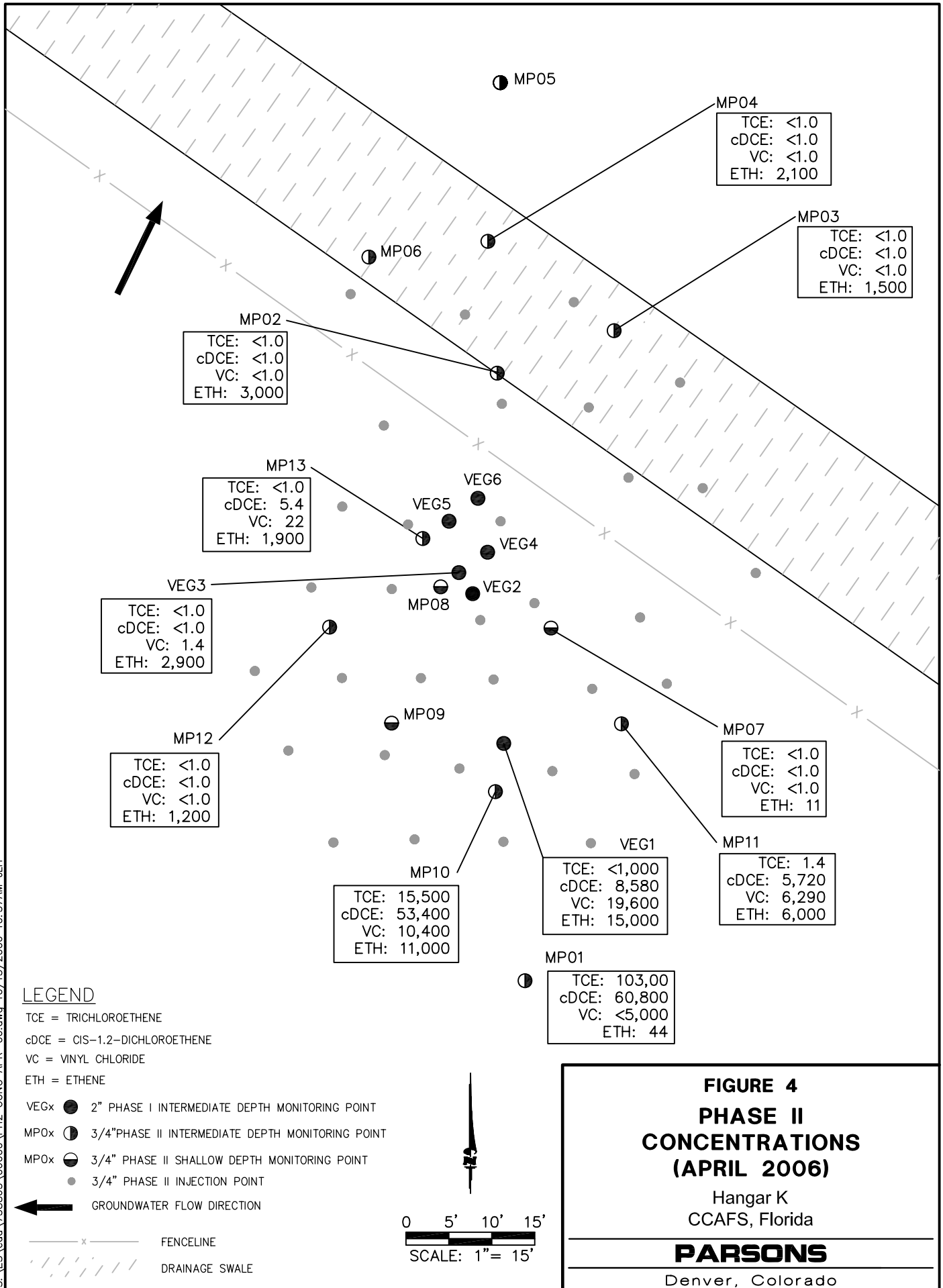


S:\ES\cad\738863\06000\04dm0255.dwg 12/20/2005 12:26PM JLH





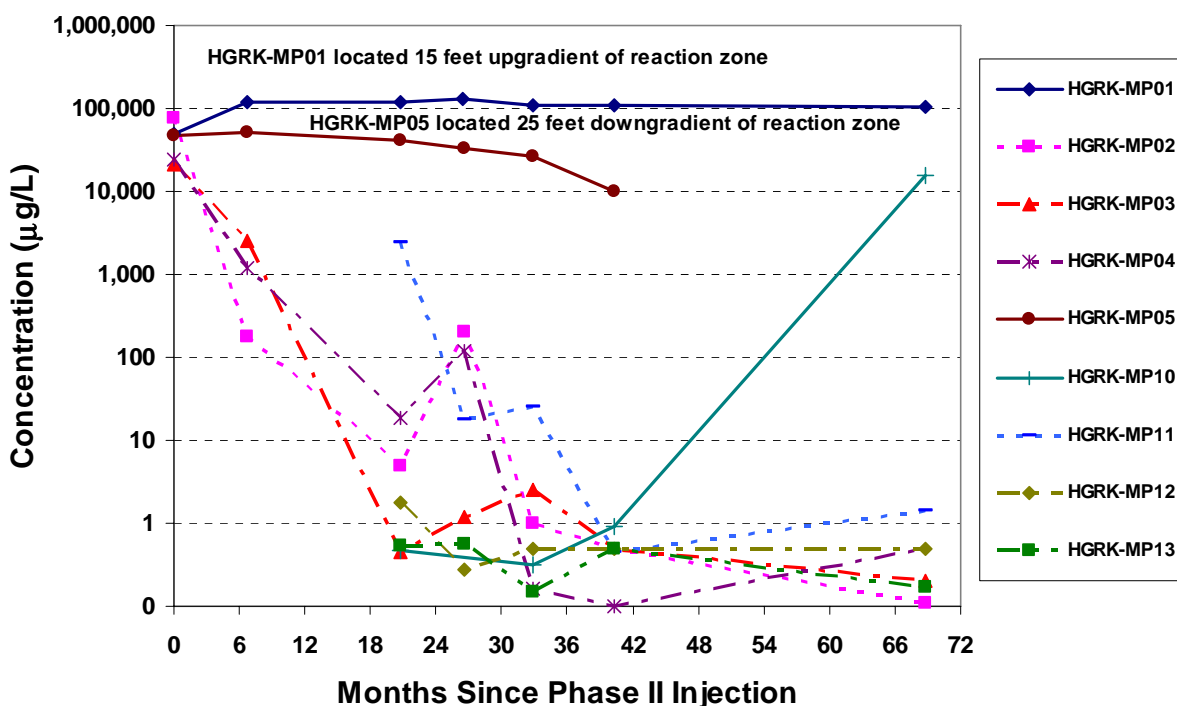
S:\ES\cad\738863\06000\PH2\_CONC\_APR-06.dwg 10/13/2006 10:57AM JLH



HGRK-MP10. The concentration of TCE rebounded at this location to 15,500 µg/L in April 2006, compared to less than 1.0 µg/L in December 2003. This monitoring location is on the upgradient side of the treatment zone, and the rebound suggests that the treatment zone may no longer be able to degrade elevated concentrations of TCE migrating from an upgradient source.

The most notable decreases in the concentration of TCE over time were within the treatment zone at monitoring points HGRK-MP02, HGRK-MP03, and HGRK-MP04 (Figure 5). The maximum concentration of TCE detected at these locations in July 2000 was 77,000 µg/L in well HGRK-MP02, which decreased after substrate injection to 180 µg/L in March 2001, and to less than 2.0 µg/L in April and December 2003. Concentrations of TCE measured in April and December 2003 were less than 5.0 µg/L at all locations sampled within the treatment zone. This represents a reduction in concentrations of TCE in groundwater of approximately four orders of magnitude. As noted previously, TCE rebounded to 15,500 µg/L at sample location HGRK-MP10 in April 2006.

Figure 5. Concentrations of TCE over Time (Phase II)



Concentrations of *cis*-1,2-DCE in Phase II monitoring points initially showed variable trends following the Phase II vegetable oil injection. Concentrations of *cis*-1,2-DCE increased at three locations and decreased at four locations in February/March 2001. An increase in *cis*-1,2-DCE is inferred to result from reductive dechlorination of TCE, while a decrease in *cis*-1,2-DCE is inferred to result from subsequent degradation of *cis*-1,2-DCE to VC.

Concentrations of TCE decreased significantly in wells showing a decrease in *cis*-1,2-DCE, suggesting that as the concentration of TCE at these wells was depleted, the rate of dechlorination of *cis*-1,2-DCE was sufficient to convert a greater mass of *cis*-1,2-DCE to VC than was produced by dechlorination of TCE to *cis*-1,2-DCE. In any event, concentrations of *cis*-1,2-DCE ultimately decreased over time, with the exception of monitoring point location

HGRK-MP10 (Table 4). Concentrations of *cis*-1,2-DCE measured in April and December 2003 were less than a drinking water standard of 70 µg/L at 8 of 10 locations sampled within the treatment zone. In April 2006, concentrations of *cis*-1,2-DCE remained less than 70 µg/L at 7 of 11 locations sampled within the treatment zone (Figure 4).

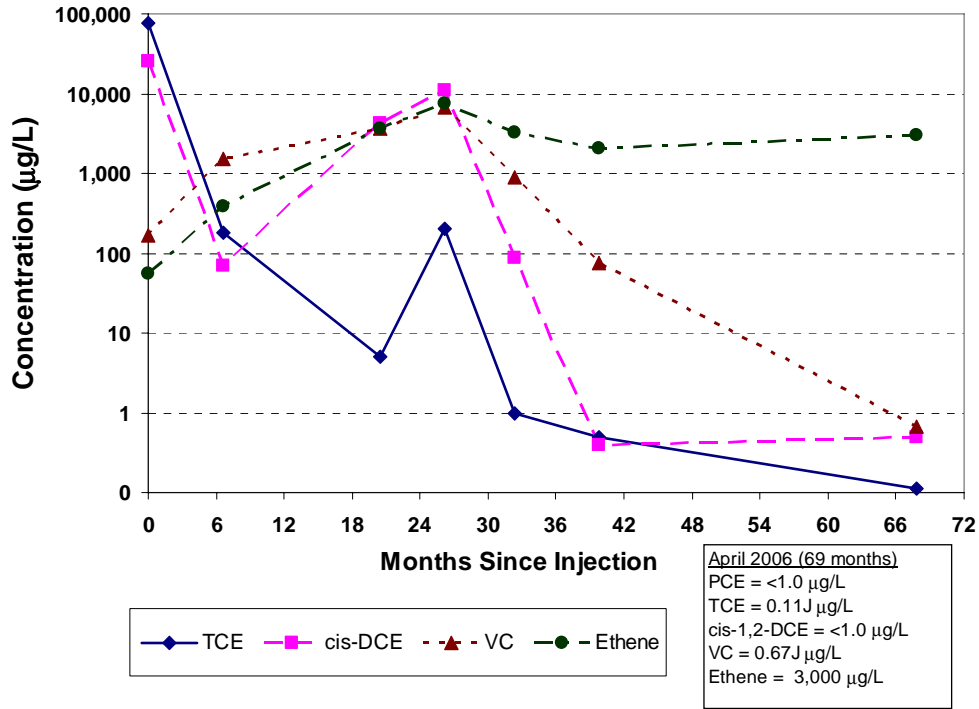
Concentrations of VC following the Phase II injection showed a uniform increase. The maximum concentration of VC detected at the Phase II monitoring locations following injection was 28,000 µg/L at HGRK-MP11 in April 2003, which subsequently declined to 3,200 µg/L in December 2003. Concentrations of VC declined at many locations over time, with concentrations of VC less than 2.0 µg/L at 5 of 10 locations sampled within the treatment zone in December 2003, and at 6 of 11 locations in April 2006. Concentrations of ethene also increased substantially within the treatment zone. The largest increase in ethene concentrations was observed at monitoring point HGRK-VEG1, with ethene as high as 15,000 µg/L in April 2006 (Table 4). The increase in ethene concentrations at the Phase II monitoring locations indicates that a significant mass of VC is being degraded to ethene.

Other supporting evidence of enhanced biodegradation, including changes in the relative concentrations of parent and dechlorination products, indicate that a substantial portion of the reduction in contaminant concentration is due to sequential reductive dechlorination. The presence of dechlorination products that were not used in Base operations, particularly *cis*-1,2-DCE, VC, and ethene, provides strong evidence that PCE and TCE are being degraded via biological reductive dechlorination. For example, the concentrations of chlorinated ethenes over time for Phase II monitoring point HGRK-MP02 are shown on Figure 6. As would be expected if reductive dechlorination was enhanced, concentrations of the more highly chlorinated ethenes (*i.e.*, TCE) decreased significantly, while concentrations of *cis*-1,2-DCE and VC initially increased. With time TCE has been depleted, and the dechlorination of *cis*-1,2-DCE to VC to ethene, results in decreases in the concentrations of *cis*-1,2-DCE and VC and an increase in the concentration of ethene.

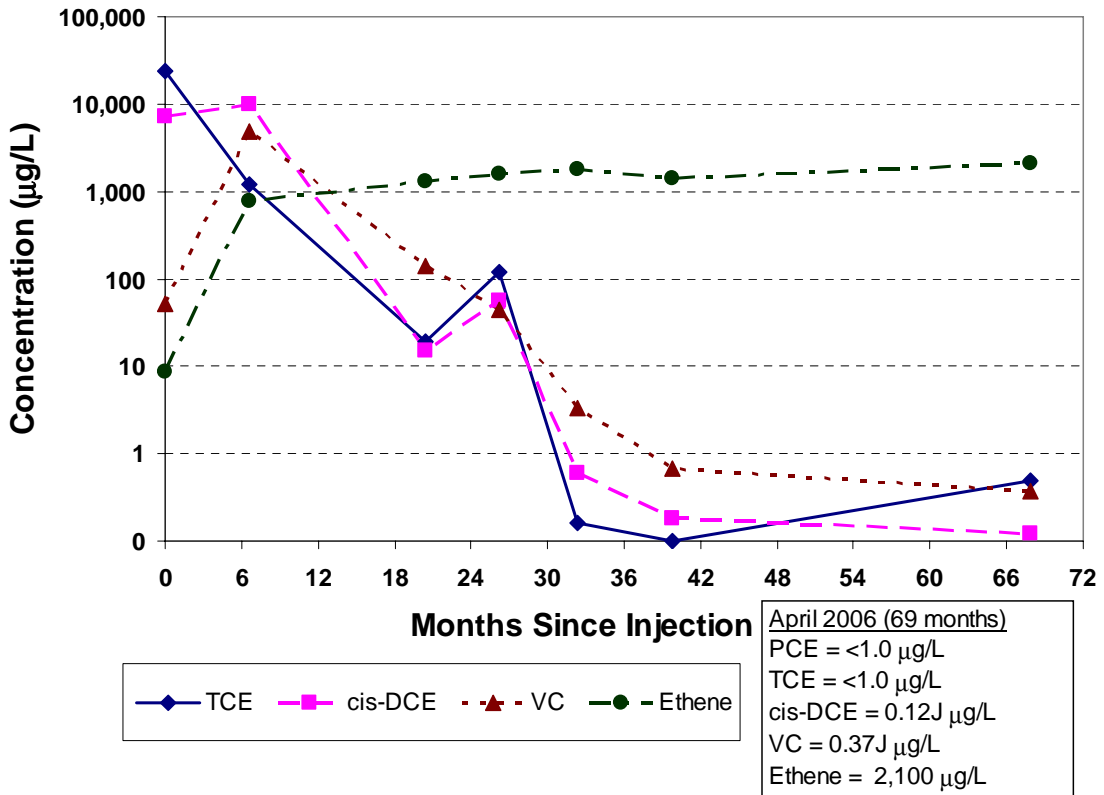
At other locations within the treatment zone, concentrations of more highly chlorinated TCE also decreased significantly, while concentrations of *cis*-1,2-DCE and VC initially increased, then decreased over time as would be expected if sequential reductive dechlorination had been stimulated. Figure 7 shows the concentrations of chlorinated ethenes at location HGRK-MP04, located approximately 10 feet downgradient from the treatment zone. Separate-phase vegetable oil or concentrations of TOC greater than 10 mg/L have not been observed at this location; therefore, it has not been directly affected by the injected vegetable oil. Concentrations of TCE, *cis*-1,2-DCE, and VC have all declined to below drinking water standards at HGRK-MP04.

Sequential transformation of PCE and TCE to ethene has been observed at all locations within the treatment zone. However, it appears that a slower rate of dechlorination of VC to ethene relative to that of the more highly chlorinated ethenes has resulted in the accumulation and persistence of VC at several locations within the treatment zone.

**Figure 6. Concentrations of Chlorinated Ethenes at Treatment Zone Location HGRK-MP02**



**Figure 7. Concentrations of Chlorinated Ethenes at Downgradient Location HGRK-MP04**



### 5.2.3 Sequestration of CAHs in Vegetable Oil

During the Phase I pilot test, samples of vegetable oil that accumulated in injection well HGRK-VEG2 following injection were collected and analyzed for CAHs during each monitoring event. These results were compared with CAH concentrations in groundwater samples from the same well to estimate a field CAH in groundwater to CAH in oil partitioning coefficient. The results of this exercise are listed in Table 5.

**Table 5. Phase I Field Partitioning Coefficients**

Location	Chlorinated Compound			
	PCE	TCE	cis-1,2-DCE	VC
<b>HGRK-VEG2 Phase I Pilot Test</b>				
Number of Oil/Groundwater Sample Pairs	--	7	7	1
Range of Field Partitioning Coefficients	--	12 - 430	32 - 186	19
<b>Average Field Partitioning Coefficient</b>	--	<b>297</b>	<b>64</b>	<b>19</b>
<b>Laboratory Study (Pfeiffer, 2003)</b>	<b>1,240</b>	<b>338</b>	<b>61</b>	<b>22</b>

Although the number of oil samples available for comparison is limited, and wide ranges of field partitioning coefficients were observed, the average field partitioning coefficients for these compounds correlate well with laboratory partitioning coefficients reported by Pfeiffer (2003) for CAHs in soybean oil. The variation in concentrations of CAHs in the oil samples may be due, in part, to the difficulty in collected representative samples of vegetable oil from the formation through small diameter PVC well screen and casing. Nonetheless, laboratory data indicate that vegetable oil can sequester approximately 300 times the concentration of TCE in groundwater, while field partitioning coefficients for *cis*-1,2-DCE (64) and VC (19) are substantially lower.

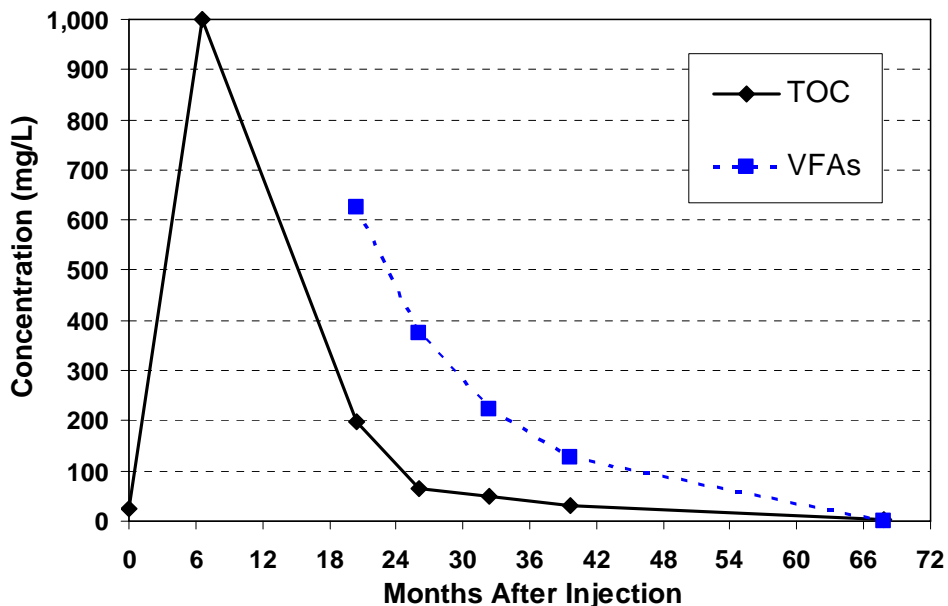
Accumulations of separate-phase vegetable oil sufficient for sampling and analyses were not observed in any monitoring points during the Phase II test. In April 2002 and April 2003, the concentrations of VC measured in select vegetable oil samples from injection wells (data not shown) were greater than concentrations of TCE and *cis*-1,2-DCE, corresponding to the relative changes in the distribution of these compounds in groundwater. The presence of sufficient vegetable oil for sampling and analyses was not observed in any monitoring or injection points in December 2003, suggesting the volume of separate-phase oil had decreased due to dissolution and microbial biodegradation.

### 5.2.4 Substrate Depletion and Longevity

To document the biodegradation and depletion of the vegetable oil substrate, concentrations of TOC were measured during performance monitoring. Beginning in April 2002, volatile fatty acids (VFAs, or metabolic acids) were also measured (Table 4). Figure 8 shows the average concentration of TOC and average concentrations of total VFAs in groundwater at monitoring wells screened within the treatment zone.

After soybean oil injection, the concentration of TOC increased to as high as 1,000 mg/L, then began a steady decline that appears to match a first-order degradation rate. VFAs also appear to decrease at a first-order rate. Concentrations of TOC in April 2006 had declined to less than 10 mg/L at all locations, indicating that the vegetable oil substrate has been depleted to background levels.

**Figure 8. Average Concentrations of Total Organic Carbon and Total Volatile Fatty Acids over Time (Phase II Monitoring Locations within Treatment Zone)**



Data collected to date indicate that the vegetable oil substrate has sustained anaerobic conditions optimal for reductive dechlorination to occur for a period of approximately 68 months, from July/August 2000 through April 2006. However, some rebound in concentrations were observed at location HGRK-MP10, indicating that the effective life span of the application has reached an endpoint. Depletion of the substrate also infers that the amount of CAH mass that may have initially partitioned into the vegetable oil must be released back into the aqueous phase over time as the volume of oil is reduced by dissolution and biological activity. Because a rebound in CAH concentrations has not been observed at locations within or downgradient from the treatment zone (with the exception of HGRK-MP10), the mass of CAHs released from the oil has likely been degraded by biological reductive dechlorination.

## 6.0 TECHNOLOGY COSTS

Total cost of the Phase I pilot test was approximately \$72,000. For the purposes of cost comparison to other full-scale enhanced *in situ* bioremediation applications, the capital/startup and operating costs for the full-scale Phase II application are presented in Table 6. Capital cost for the full-scale application were approximately \$97,000. The cost for installation of the Phase II injection and monitoring system and conducting the substrate injection was approximately \$67,000; of which \$5,700 was for the vegetable oil substrate, and approximately \$30,000 was for installation of the injection and monitoring points by the US Army Corps of Engineers (USACE) (labor and equipment). Approximately \$11,000 was expended for work plan development and

planning, approximately \$8,000 was spent for baseline laboratory analyses and monitoring equipment/supplies, and approximately \$11,000 was spent for reporting (Table 6).

The cost for performance monitoring averages approximately \$24,000 per sampling event, including project management, procurement, and reporting. To date, six Phase II performance monitoring events have been conducted over the 69-month period from July 2000 through April 2006. Total costs to date for the Phase II demonstration are approximately \$241,000.

**Table 6. Phase II Technology Demonstration Costs**

<b>Element Cost</b>	
<b>Capital Cost</b>	
Planning and Preparation	\$11,000
Mobilization/Demobilization/Per Diem	\$2,800
Site Labor	\$20,000
USACE CPT Rig (equipment and labor, estimated)	\$30,000
Equipment and Appurtenances	
-Injection and Monitoring Points	\$6,100
-Injection System	\$900
-Substrate (vegetable oil, delivered)	\$5,700
-Monitoring Equipment and Supplies	\$2,000
Baseline Laboratory Analyses	\$6,000
Surveying	\$1,500
Reporting	\$11,000
<b>Total Capital Costs</b>	<b>\$97,000</b>
<b>Operating Costs (Performance Monitoring)</b>	
Mobilization/Demobilization/Per Diem	\$2,500
Direct Labor (Performance Monitoring)	\$7,500
Sampling Equipment and Supplies	\$2,000
Laboratory Analysis	\$6,000
Project Management/ Procurement/Reporting	\$6,000
<b>Operating Costs per Event</b> (\$144,000 for six events over 68 months)	<b>\$24,000</b>

## 7.0 SUMMARY OBSERVATIONS AND LESSONS LEARNED

The injection of vegetable oil has enhanced reductive dechlorination of chlorinated ethenes (PCE, TCE, DCE, and VC) in groundwater at the Hangar K Site. Both pilot- and full-scale studies demonstrated that reductive dechlorination could be enhanced by supplementing the natural concentrations of organic carbon via injection of food-grade soybean oil. Phase II chlorinated ethene data indicate a dramatic reduction in concentrations of TCE, and in most locations reductions in *cis*-1,2-DCE and VC. While partitioning of chlorinated ethenes into the vegetable oil may account for the observed initial reductions in aqueous-phase contaminant concentrations, ratios of molar concentrations of the parent and dechlorination products indicate that much of the observed contaminant reductions are due to sequential reductive dechlorination. While VC has apparently accumulated at a few locations within the treatment zone, the observed increases in ethene concentrations indicate that VC is being dechlorinated.

The apparent accumulation and persistence of VC may be due in part to slower reaction kinetics for the dechlorination of *cis*-1,2-DCE and VC, and/or a continuing source of TCE migrating into the treatment zone, sorbed to the aquifer matrix, or present as residual DNAPL

## **APPENDIX H.2**

### **Enhanced Anaerobic Biodegradation of Trichloroethene Using Edible Oil in A Permeable Biobarrier**



## Enhanced Anaerobic Biodegradation of Trichloroethene Using Edible Oil in a Permeable Biobarrier

Christie Zawtocky, P.E., Robert C. Borden, Ph.D, P.E., M. Tony Lieberman  
Solutions Industrial & Environmental Services, Inc., Raleigh, NC

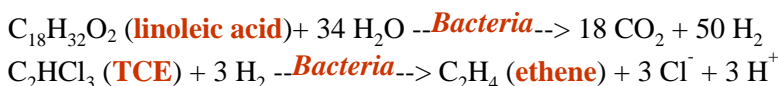
and

Michael D, Lee, Ph.D.  
Terra Systems, Inc., Wilmington, DE

### Introduction

A novel, low-cost technology has been developed for delivering a low solubility, slowly degradable substrate to the subsurface to enhance the *in situ* biodegradation of a variety of groundwater contaminants including chlorinated solvents, perchlorate, hexavalent chromium, nitrate, and oxidized radionuclides. The EOS™ (Edible Oil Substrate) process blends food-grade vegetable oil and surfactants in a high-speed mixer to generate an oil-in-water emulsion with a small droplet size that can be easily distributed throughout the subsurface (US Patent #6,398,960). The emulsion is injected through permanent wells or temporary direct-push points. Water is subsequently injected to distribute and immobilize the oil. Once in the subsurface, the oil slowly biodegrades over time providing a slow continuous source of dissolved organic carbon (i.e., fermentation products) to support biodegradation of the target contaminants. Degradation of the oil results in removal of oxygen and production of hydrogen (H<sub>2</sub>). The hydrogen itself then drives the desired anaerobic biological metabolism. These microbial metabolic transformations are illustrated in the following equations using linoleic acid as a representative fatty acid in soybean oil:

#### Sequence of Reactions Using Fats or Oils



Implementation of the EOS™ process involves on-site preparation of the emulsion and injection of the emulsion into the treatment zone. The EOS™ can be injected into “hot spots”, throughout the plume or as a permeable reactive barrier using conventional wells or direct-push injection points. All materials used in the process are “Generally Recognized as Safe”, food-grade materials (21 CFR 184.1400) which typically facilitates obtaining regulatory approval for *in situ* application. The amount of EOS™ injected into the subsurface is determined based on the concentrations of the target compounds, the concentrations of various biodegradation and geochemical parameters, and the geologic and hydrogeologic conditions.

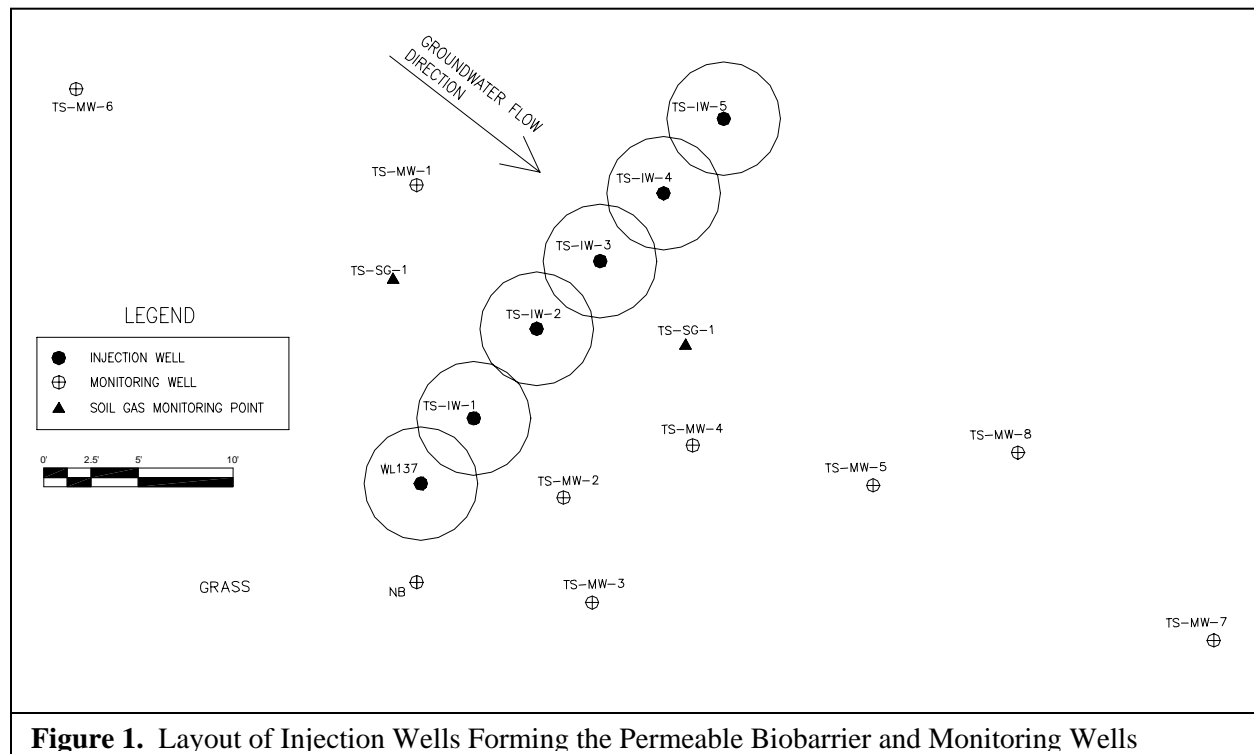
### Site Description

The Air Force Center for Engineering and the Environment (AFCEE) sponsored a field pilot study at Altus Air Force Base (AFB) in Altus, Oklahoma to evaluate the use of emulsified oil for stimulating *in situ* anaerobic bioremediation of chlorinated solvents. Historical solvent releases of degreasing agents at Altus AFB resulted in a 5,000-ft long chlorinated solvent plume with

TCE concentrations reaching 78,000 µg/L in the source area. Geology at the site consists of reddish-brown, moderately plastic, sandy clay to a depth of roughly 15 feet below ground surface (ft bgs), underlain by fractured clayey shale with occasional gypsum layers. The depth to groundwater is approximately 8 to 10 ft bgs. Most groundwater flow and contaminant transport appears to occur through a series of weathered shale fractures located immediately beneath the surficial clay and within a thick gypsum layer approximately 35 ft bgs. Field observations suggest a groundwater velocity approaching 100 ft/year.

### Substrate Preparation and Injection

The area selected for the pilot study was approximately 250 ft downgradient from the source area. A line of six permanent 2-inch polyvinyl chloride (PVC) wells spaced 5 ft apart was installed perpendicular to groundwater flow, and a series of monitoring wells and soil gas monitoring points were installed upgradient and downgradient of the injection wells to allow monitoring of the pilot study. Figure 1 shows the layout of the pilot test area.



**Figure 1.** Layout of Injection Wells Forming the Permeable Biobarrier and Monitoring Wells

Over a 4-day period in December 2001, a mixture of emulsified soybean oil, lactate and yeast extract was injected through each well to form a 30-ft wide EOS™ permeable reactive barrier that would stimulate reductive dechlorination. Each injection was designed to treat a 6-ft diameter area to provide a small overlap between adjacent injection points. This provided a biobarrier approximately 30 feet in width. To achieve maximum distribution of the treatment mixture in the upper weathered fracture zone, the wells were screened from 8 to 18 ft bgs. A total of approximately 760 gallons of emulsion was injected consisting of approximately 1,270 lbs of soybean oil, 266 lbs of emulsifier composed of glycerol monooleate and polysorbate 80,

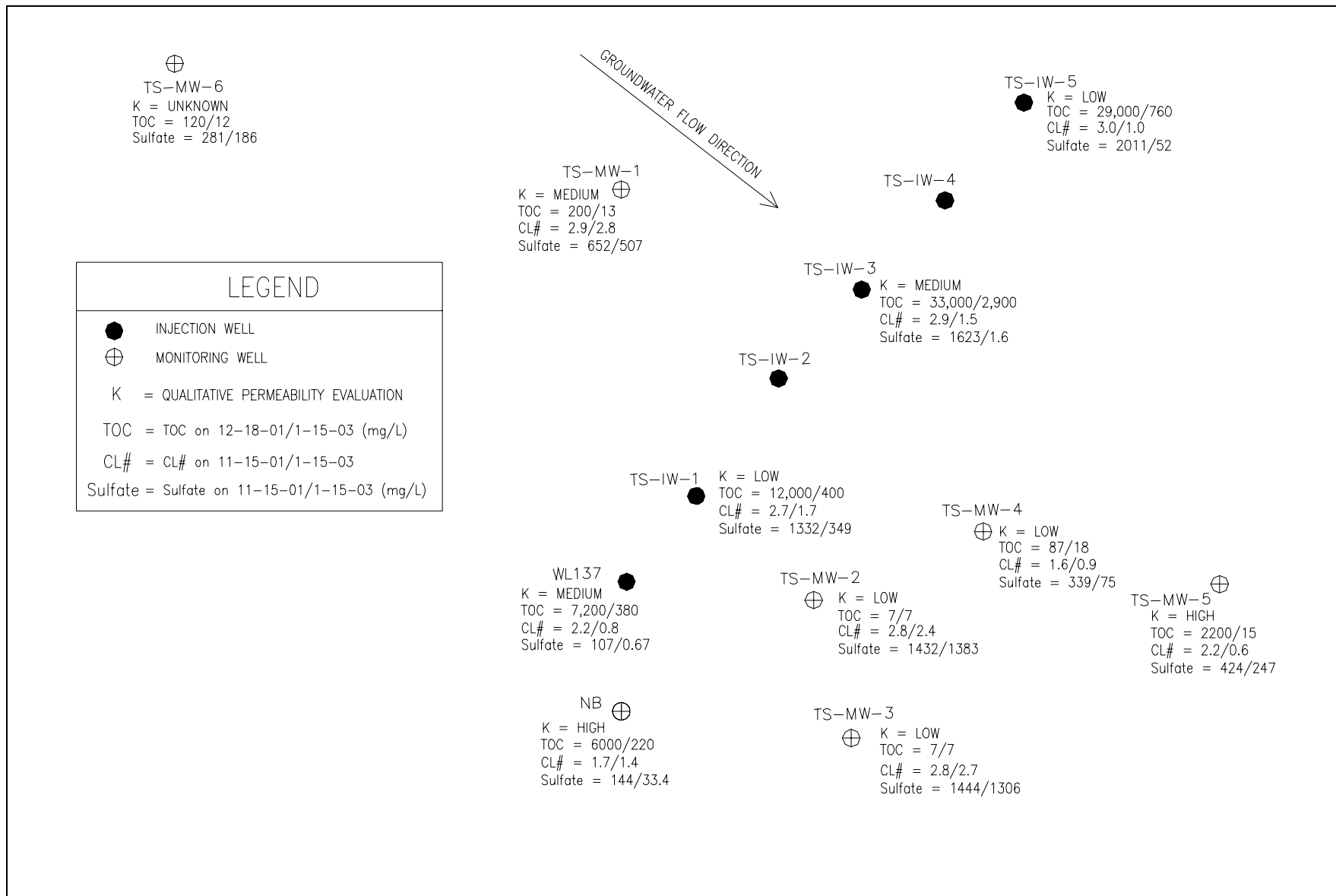
26 lbs of lactate and 9.8 lbs of yeast extract. Significantly more emulsifier was used in the field than required to form a stable emulsion. However, excess surfactant was available and was used to simplify the injection process. All emulsifiers used were readily biodegradable and, as such, served as additional active substrate for reductive dechlorination. Injection of the emulsion was followed by injection of approximately 800 gallons of water to help distribute the emulsion throughout the treatment zone.

### **Substrate Distribution**

Visual observations and measurements of total organic carbon (TOC) were used to evaluate the distribution of the emulsified oil in the subsurface. During the injection process, emulsified oil was observed more than 20 feet downgradient from the injection points at monitoring well TS-MW-5. Figure 2 shows the distribution of TOC, sulfate and chlorine number, as described below, in the pilot test area on December 18, 2001 (1 day after injection) and January 15, 2003 (13 months after injection).

To aid in evaluating the effects of formation permeability on emulsion distribution, wells were classified as having low, medium, and high conductivities. “Low” represents hydraulic conductivity values of 15 to 40 ft/year; “Medium” is between 80 and 150 ft/year; “High” is over 500 ft/year. Because slug tests were only performed on selected wells, other field observations were used to provide a qualitative indication of hydraulic conductivity in every well in the pilot test area. Data used in this evaluation included observations from well development activities, flow rates recorded during injection, and visual observations during drilling. Results of this evaluation are shown in Figure 2.

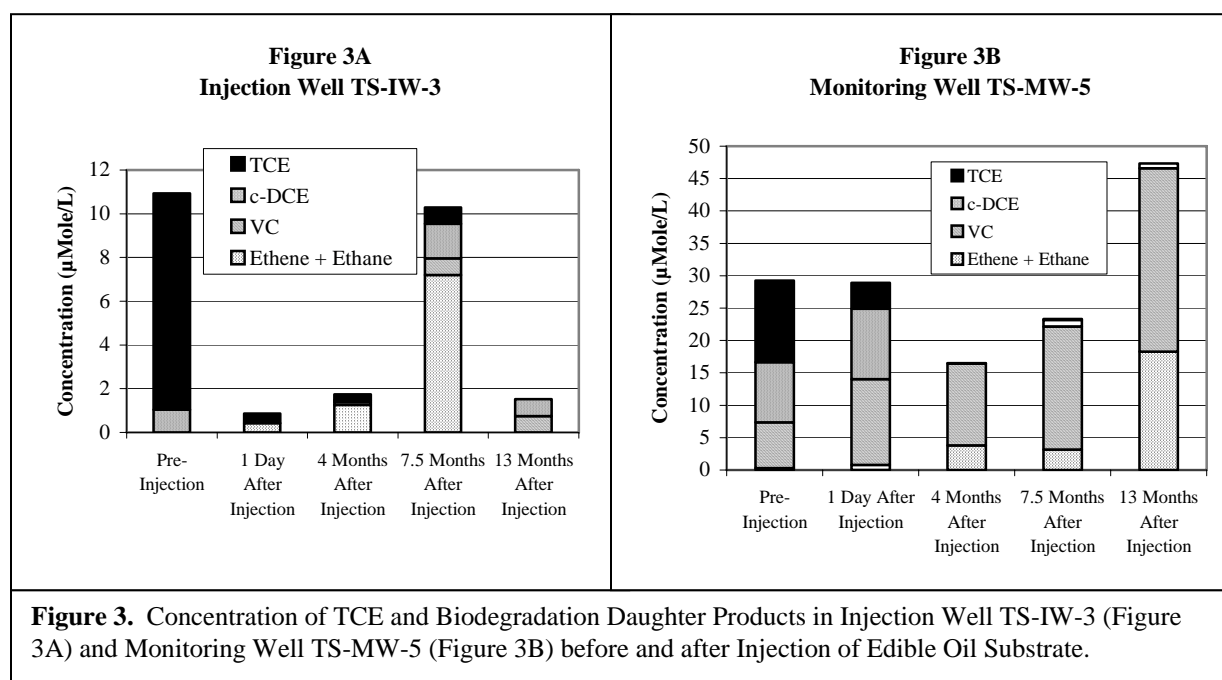
As shown in the figure, immediately after injection, the injection wells had between 7,200 and 33,000 mg/L TOC and elevated TOC levels were observed as far as 20 feet downgradient in well TS-MW-5 (2,200 mg/L). However, some of the monitoring wells closer to the injection points did not show substantial increases in TOC. As expected, the emulsion distribution is highly dependent on the *in situ* permeability distribution. In higher permeability areas, emulsion can be distributed over 20 feet away from the injection points.



**Figure 2. Relative Hydraulic Conductivity, Total Organic Carbon, Sulfate and Chlorine Number throughout Pilot Test Plot**

## Chlorinated Aliphatic Hydrocarbon Results

The analytical monitoring results from the Altus AFB pilot study show that emulsion injection is effective in stimulating reductive dechlorination processes. TCE concentrations dropped immediately after injection, as illustrated by the data from injection well TS-IW-3 (Figure 3A). Although the concentrations of total ethenes [TCE, *cis*-1,2-dichloroethene (*cis*-DCE), vinyl chloride (VC), ethene and ethane] initially decreased, these temporary reductions were likely due to dilution and/or sorption to the oil. As Figure 3A illustrates, approximately 7.5 months after injection, the concentration of total ethenes (molar concentration) was more than 90 percent of the pre-injection TCE concentration. This demonstrates that dilution/sorption was no longer significant and that the observed reductions in contaminant concentrations were due to biodegradation. Over the 13-month interval since edible oil injection, TCE has declined from 9.9  $\mu\text{M/L}$  (1,300  $\mu\text{g/L}$ ) to below the detection limit (BDL) in the center injection well.



Similar results were observed in monitoring well TS-MW-5, 20 feet downgradient of the barrier (Figure 3B). Emulsion reached TS-MW-5 immediately after injection, as evidenced by a rise in TOC to 2200 mg/L one day after application. Post-injection monitoring over 13 months has shown that TCE decreased from 12.6  $\mu\text{M/L}$  (1,660  $\mu\text{g/L}$ ) to BDL and *cis*-DCE from 9.3 to 0.75  $\mu\text{M/L}$  (900 to 73  $\mu\text{g/L}$ ). There has been a concomitant increase in VC from 7.0 to 28.3  $\mu\text{M/L}$  (440 to 1,770  $\mu\text{g/L}$ ) and ethene from 0.25 to 18.2  $\mu\text{M/L}$  (6.9 to 510  $\mu\text{g/L}$ ). The increase in total ethenes (molar concentration) in this well may be a result of enhanced desorption/dissolution as dissolved TCE is removed through enhanced reductive dechlorination. Although TOC has substantially decreased from the starting concentration, the continuous downgradient migration of dissolved TOC from areas closer to the injection barrier would be expected to support additional reduction of VC to ethene and ethane.

Chlorine number is another approach for evaluating the effect of anaerobic biotransformation processes, particularly the extent to which sequential degradation of PCE or TCE is occurring. Groundwater containing only TCE would have a chlorine number = 3.0. However, if half of the TCE is reduced to DCE, the chlorine number would decline to 2.5. Chlorine number is calculated as:

$$\text{Chlorine number} = \frac{4 [\text{PCE}] + 3 [\text{TCE}] + 2 [\text{DCE}] + [\text{VC}]}{[\text{PCE}] + [\text{TCE}] + [\text{DCE}] + [\text{VC}] + [\text{ethene}] + [\text{ethane}] + [\text{acetylene}]}$$

where [ ] indicates concentration in moles per liter. When calculating the chlorine number, non-detect measurements equal to zero are assumed and ethene, ethane and acetylene are assumed stable under reducing conditions. The change in chlorine number to <1.0 suggests complete transformation from chlorinated parent molecules to non-chlorinated, non-toxic, end products.

Chlorine number values for the pre-injection monitoring event (November 15, 2001) and the January 2003 monitoring event (13 months after injection) are presented on Figure 2. There was a substantial decline in chlorine numbers in all of the injection wells following emulsion injection. In contrast, there was no significant change in chlorine number in upgradient monitoring well TS-MW-1. In the downgradient monitoring wells, the results were more variable. In TS-MW-5, the chlorine number dropped from 2.17 prior to injection to 0.63 in January 2003 indicating substantial conversion of TCE to lesser-chlorinated compounds. However, in downgradient monitoring wells TS-MW-2 and TS-MW-3 there was no substantial change in chlorine number with time.

The degree of biodegradation is dependent on distribution of emulsion in the aquifer, which is dependent on the aquifer's permeability. In locations of higher permeability where fluids would preferentially flow, a substantial increase in reductive dechlorination processes was observed. In areas with low permeability which would restrict fluid flow, there is no significant enhancement of reductive dechlorination. This effect is illustrated in Figure 2. In wells with TOC > 10 mg/L, the chlorine number is reduced to less than 2.0. However, when TOC is <10 mg/L, chlorine number remains high and there is little evidence for significant reductive dechlorination. This is true whether the well is upgradient, downgradient, or within the barrier.

### **Bioparameter Results**

A variety of bioparameters were monitored over the course of the pilot test to evaluate the effects of emulsion injection to create conditions conducive for reductive dechlorination.

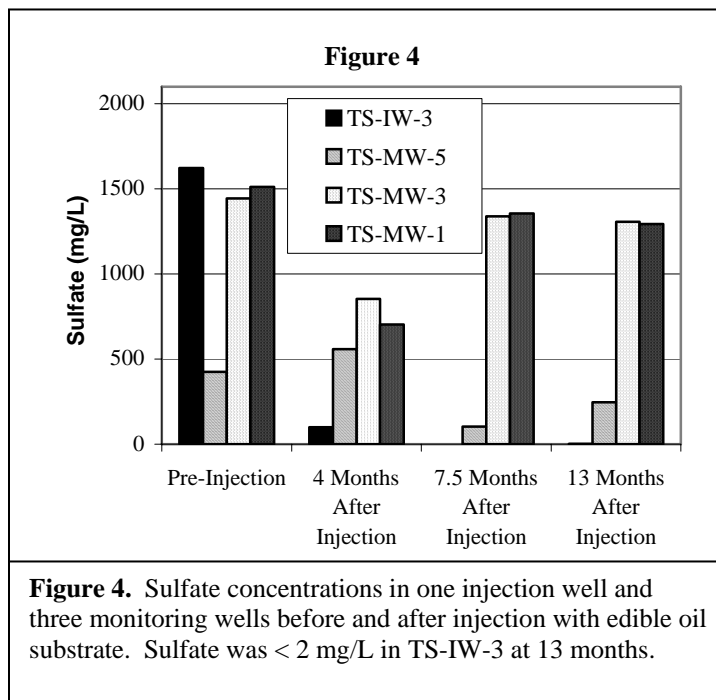
Dissolved oxygen (DO) is used by microbes as an electron acceptor for the biodegradation of organic carbon. The emulsified oil provides a source of carbon for aerobic microbes to metabolize, in turn depleting dissolved oxygen concentrations and creating anaerobic conditions favorable to enhanced reductive dechlorination. Pre-injection DO levels varied widely across the pilot test area. An average DO of 0.82 mg/L was calculated from injection wells WL-137, TS-IW-1 and TS-IW-3 and monitoring wells NB, TS-MW-3 and TS-MW-2 in the south-southwest part of the plot. By contrast, the average DO was 3.9 mg/L in the northern-most injection wells TS-IW-5 and TS-IW-4 and the most eastern monitoring wells, TS-MW-4 and TS-MW-5. The

introduction of organic substrate to the aquifer caused a DO response that was observable 1 day after injections were completed. DO concentrations ranged from 0.08 to 0.36 mg/L in injection and monitoring wells with measurable increases in TOC with DO concentrations generally lower in wells with lower starting concentrations. Since injection, anaerobic conditions have persisted at the site.

The presence of methane above background conditions indicates microbial degradation (methanogenesis) is occurring and conditions are favorable for reductive dechlorination. Methane concentrations have generally increased in the injection and monitoring wells since injection of the oil emulsion. Methane levels above 7,000 µg/L were observed in every injection well sampled in July 2002. Elevated methane levels have also been observed in most of the downgradient monitoring wells, but not in the shallow (5 ft bgs) soil gas monitoring points above the water table.

Substantial amounts of dissolved and solid-phase sulfate are present at Altus AFB. Sulfate can reduce the effectiveness of reductive dechlorination by: (1) competing for available H<sub>2</sub>, reducing the rate and extent of reductive dechlorination; (2) producing toxic levels of sulfide that could inhibit reduction dechlorination processes; and (3) accelerating the biodegradation of soybean oil, requiring more frequent emulsion injection. Pre-injection sulfate concentrations as high as 2,011 mg/L were detected in the pilot test area wells. As shown in Figure 4, sulfate levels have dropped dramatically in the wells that were impacted by the emulsion injection (TS-IW-3 and TS-MW-5), and have remained relatively unchanged in wells that were not impacted by the emulsion (upgradient well TS-MW-1 and low permeability well TS-MW-3). Pre- and post-injection sulfate data are also displayed on Figure 2, which illustrates that areas impacted by the emulsion displayed increases in TOC and corresponding decreases in both sulfate and chlorine number.

These data show that competition for available H<sub>2</sub> by sulfate reducers has not inhibited reductive dechlorination processes. Many of the wells have evidence of a black precipitate suggesting that free sulfide is being precipitated with soluble iron as ferrous mono- or di- sulfide, thus preventing accumulation of inhibitory levels of dissolved sulfide. Ferrous mono- sulfide and di- sulfide can abiotically react with TCE, yielding acetylene and other reduced ethenes. Although low levels of acetylene have been detected, the abiotic reaction does not seem to be the dominant TCE removal mechanism at this site.



Continued monitoring will be necessary to verify whether the high levels of sulfate in the aquifer accelerate the consumption of the emulsion.

### **Effect of Emulsion Injection on Permeability**

Slug-in and slug-out hydraulic conductivity tests were conducted in the pilot test wells before and after injection of the emulsion to evaluate changes in the aquifer permeability. Pre-emulsion injection hydraulic conductivities varied from 0.02 ft/day to 2.8 ft/day over the approximately 50-ft by 50-ft test area. Emulsion injection did not have a significant impact on the hydraulic conductivity of the injection wells or monitoring wells. In WL-137, which was treated with emulsion, the pre-injection hydraulic conductivity values were 0.34-0.45 ft/day while the post-injection values were 0.20-0.45 ft/day. Similar results were obtained in other injection and monitoring wells that had hydraulic conductivity tests conducted before and after emulsion injection.

### **Soil Gas Monitoring**

Because the pilot test was conducted within the upper unconfined unit, the potential for accumulation of methane and other volatile gases in the unsaturated soils overlying the aquifer was evaluated. Two dedicated soil-gas monitoring points were installed to a depth of 5 ft bgs in the pilot test area to allow monitoring of accumulated volatile organic compounds (VOCs). The headspace of the monitoring points was monitored in the field for percent lower explosive limit (LEL), percent oxygen, hydrogen sulfide, and carbon monoxide using a VRAE monitor. While both soil gas monitoring points had low oxygen readings, neither had detectable LELs. No elevated LEL readings were noted at the surface. This suggests that the methane is being consumed aerobically before it reaches the surface. Neither hydrogen sulfide (H<sub>2</sub>S) nor carbon monoxide (CO) was detected in the headspace of the soil gas monitoring points.

### **Longevity**

The longevity of the emulsion in the subsurface is important to achieve continued reductive dechlorination. If the edible oil emulsion biodegraded too rapidly, then the design life of the barrier is reduced and re-injection could be necessary to reduce contaminant concentrations to the desired levels. As of the last sampling event, the biobarrier at Altus AFB continued to release desirable amounts of organic carbon both within the barrier and to downgradient monitor wells. Approximately 13 months after injection, the TOC in the injection wells was between 850 mg/L and 7,300 mg/L and the TOC at monitoring well TS-MW-5 located 20 feet downgradient of the barrier was over 15 mg/L. Continued monitoring would further evaluate the longevity of the single emulsion injection.

### **Conclusions**

The overall conclusion from the SS-17 pilot test is that addition of slowly biodegradable organic carbon in the form of a soybean oil-in-water emulsion can enhance reductive dechlorination. Although ferrous sulfide and ferrous disulfide have been produced in the vicinity of the barrier at



concentrations between six and nine times greater than observed at a background location, there is little evidence for dechlorination via the abiotic pathway leading to acetylene.

Biological enhancement is dependent on the distribution of emulsion in the aquifer. Where contaminated groundwater came immediately in contact with the soybean oil emulsion, we observed a substantial increase in reductive dechlorination processes. This includes both the barrier injection wells and downgradient monitoring wells. In these locations, chlorine numbers generally declined providing strong evidence for significant reductive dechlorination.

## **Costs**

The costs for the tasks involved in the design and implementation of the pilot-scale study are discussed below. Because this was a pilot test, the higher than average costs reflect the expanded effort to collect detailed scientific and engineering data to evaluate the performance of the oil emulsion barrier. On a commercial scale, a significantly reduced pilot test could provide preliminary design information sufficient for a full-scale remedial effort. The cost elements associated with each task at Altus AFB are discussed below:

*Work Plan and Barrier Design (\$30,000) and Draft Interim Report (\$28,700).* The work plan and engineering design included evaluation of extensive pre-existing site data provided by others, a preliminary site visit and injection test, preparation and in-house testing of alternate emulsion mixes, and writing a detailed Quality Assurance Project Plan (QAPP) and Health and Safety Plan (HASP). At the end of the performance monitoring period, a thorough and detailed Draft Interim Report was prepared summarizing the data acquired from pre- and post injection sampling activities.

*Injection and Monitor Well Installation (\$37,000).* Six groundwater injection wells were installed 5 ft on center creating a 30-foot long barrier. Each injection well was screened from 8 to 18 ft bgs to intersect contamination in the shallow aquifer above the confining layer. Eight groundwater monitoring wells were also installed within 40 feet of the barrier and one vadose zone soil-gas monitor well was installed on either side of the barrier. Despite the relatively shallow depth of the test (i.e., less than 18 ft bgs), installing wells through the clay and into the weathered shale precluded direct push technologies such as Geoprobe<sup>®</sup>. Installing permanent injection and monitoring wells using hollow stem auger drilling methods served to provide long-term sampling points for increased data acquisition and evaluation of the pilot-test results. The unit cost per well installed using hollow stem auger drilling methods was \$2,300 to \$2,500 per well.

*Emulsion Preparation and Injection (\$24,300).* The entire process of preparing the emulsion in the field, injecting it and completing the water chase required 4 days to accomplish. The materials and installation costs are summarized in the following table:

<b>Costs for Installation of Oil Emulsion Barrier at Altus AFB</b>			
	<b>Oil Emulsion Substrate (~1,600 lbs)</b>	<b>Preparation and Injection of Substrate</b>	<b>Total</b>
Total Cost	\$1,300	\$23,000	\$24,300
Per Injection Well (6 wells)	\$215	\$3,830	\$4,045
Per Linear Ft (30 linear ft)	\$43	\$767	\$810
Per Sq Ft (300 sq ft)	\$4.30	\$77	\$81.30

*Performance Monitoring (\$52,800).* Performance monitoring has included both groundwater and permeability testing with concomitant data evaluation at each of four sampling events performed over the first 13 months of the project. Six injection wells and eight monitor wells were sampled in accordance with the work plan. In addition, slug tests were performed on four wells during each event. Analytical costs represent almost 28 percent of the cost for each sampling event.

*Summary and Estimate of Full Scale Costs:* The cost for implementing the pilot test project, up to and including 13 months of field evaluation, was \$172,800. The information gained is directly applicable for scale up to a full-size barrier.

The installation of two staggered 400-ft biobarriers approximately 20 feet apart (assumed coverage needed at Altus AFB) would incur certain fixed costs including design, work plan and report preparation, that would likely be of similar, or slightly lesser magnitude, than discussed above. Performance monitoring costs would be included in compliance monitoring using pre-existing monitoring wells downgradient of the biobarriers. Analysis of a few additional parameters in these wells would serve to confirm that the remediation was performing as designed.

Based on the pilot-test information, temporary injection wells could be used and the injection interval could be extended to 10 ft on center. With these changes, unit drilling costs would decrease to approximately \$1,100 per well resulting in well installation and abandonment costs of \$88,000 for 80 injection wells. Costs for substrate would increase incrementally to \$34,300, but costs for injection would be expected to drop to approximately \$350 per linear foot as simultaneous injections of multiple wells would decrease time on site. Thus, field costs to install two 400-foot barriers are estimated to be \$405,000, or approximately \$500 per linear foot of barrier.

### **APPENDIX H.3**

#### **Enhanced *In Situ* Anaerobic Bioremediation of Chlorinated Ethanes Using Emulsified Vegetable Oil**

# **ENHANCED *IN SITU* ANAEROBIC BIOREMEDIATION OF CHLORINATED ETHANES USING EMULSIFIED VEGETABLE OIL**

Susan Ferris, PG (Parsons, Cincinnati, OH) and Bruce Henry, PG (Parsons, Denver, CO)  
Carl Coker and Ronald Lantzy, PhD, PG (Rohm and Haas, Croydon, PA)

## **1. INTRODUCTION**

Groundwater has been impacted by release of chlorinated aliphatic hydrocarbons (CAHs, or chlorinated solvents) at a former industrial site in the Midwest. CAHs detected in groundwater include 1,1,1-trichloroethane (1,1,1-TCA) and related degradation products including 1,1-dichloroethane (1,1-DCA), 1,1-dichloroethene (1,1-DCE), and chloroethane (CA). Injection of various organic substrates have proven to be effective in enhancing anaerobic biodegradation of chlorinated solvents in groundwater. Many examples of enhanced bioremediation of chlorinated ethenes are available in the literature; however, fewer case studies for chlorinated ethanes are available. Therefore, a pilot test of enhanced *in situ* anaerobic bioremediation was conducted from March 2004 to November 2005 (Ferris *et al.*, 2006). After the pilot test was conducted, a full-scale injection was conducted beginning in December 2005 that was designed to remediate CAHs (both chlorinated ethanes and chlorinated ethenes) in groundwater across the entire site.

This case study describes the objectives, technical approach, and results of the pilot study, as well as the implications of the pilot test for the full-scale design. The technical approach utilized at this site included a combination of a readily degradable, soluble substrate (sodium lactate) to quickly establish anaerobic conditions, with a slow-release substrate (emulsified vegetable oil) to sustain the reaction zone. The design life of the pilot test was 18 to 24 months, with the full-scale remedy being implemented at approximately 21 months after the pilot test injection.

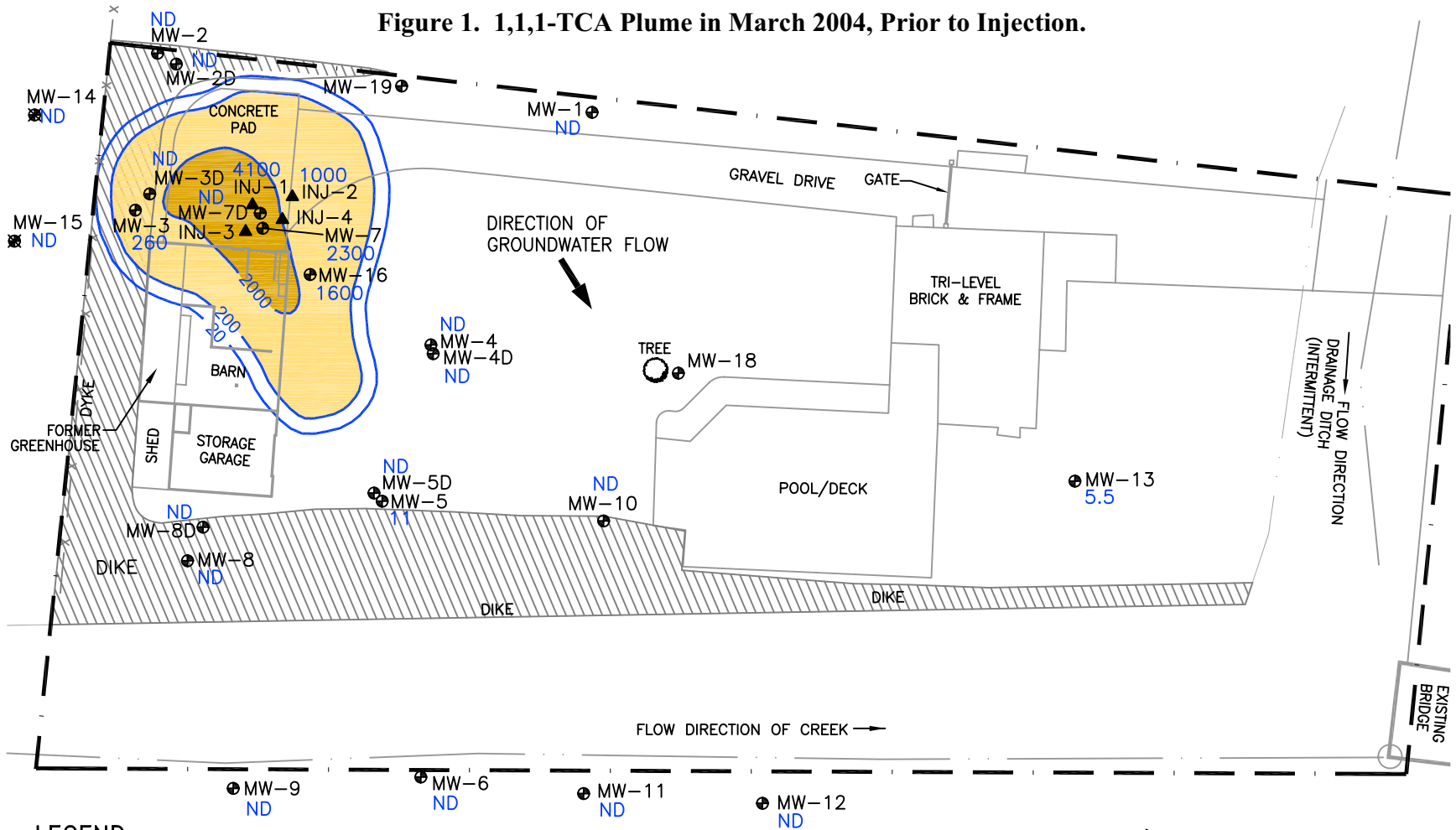
## **2. PILOT TEST OBJECTIVES**

The objectives of the enhanced bioremediation pilot test were to 1) evaluate the effectiveness of enhanced *in situ* anaerobic bioremediation to remediate chlorinated ethanes and chlorinated ethenes in groundwater at the site, and 2) produce critical design data for use in full-scale implementation of the technology. The primary performance objective of the pilot test was to determine if enhanced bioremediation is capable of restoring groundwater quality to regulatory action levels for all CAHs present. Regulatory action levels for CAHs in groundwater are United States Environmental Protection Agency's (USEPA) Maximum Contaminant Levels (MCLs) for drinking water. In the case that a MCL had not been established for a particular constituent, USEPA Region 9's Preliminary Remediation Goals (PRGs) for tap water were used.

## **3. TECHNICAL APPROACH**

The pilot test utilized a mixed substrate of sodium lactate and vegetable oil. The reaction zone included four injection wells (INJ-1 through INJ-4, see Figure 1). The wells were spaced 10 feet (3 meters) apart, designed for a 5-foot (1.5-meter) radius of influence surrounding each well. The substrate mixture was injected through a 10-foot (3-meter) screen in each of the four injection wells in March 2004. The substrate mixture was prepared by combining: (1) 110 gallons of a pre-emulsified commercial product containing 46 percent soybean oil by weight, 40 percent water by weight, approximately 10 percent food-grade emulsifiers by weight, and 4.0 percent sodium lactate by weight; and (2) approximately 3,350 gallons of site groundwater amended with sodium lactate to a concentration of approximately 0.5 percent sodium lactate by weight. Based on the volume of soybean oil and emulsifiers in the commercial product and the total volume of the substrate mixture, the effective saturation of oil and emulsifiers in the injected substrate mixture was approximately 1.8 percent.

Figure 1. 1,1,1-TCA Plume in March 2004, Prior to Injection.

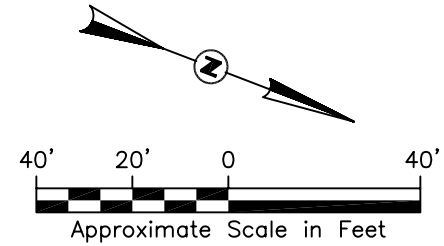


**LEGEND**

- ⊕ MONITORING WELL
- ⊗ ABANDONED MONITORING WELL
- ▲ INJECTION WELL
- PROPERTY BOUNDARY
- x- FENCE
- 5.5 1,1,1-TRICHLOROETHANE CONCENTRATION (ug/L)
- 200 1,1,1-TRICHLOROETHANE ISOCONCENTRATION LINES (ug/L)
- ND NOT DETECTED

CONCENTRATIONS IN GROUNDWATER EXCEEDING MCL

	200 - 2000
	2000 - 4100



A total of 3,460 gallons of the mixture was injected into the four injection wells, ranging from 809 gallons into INJ-4 to 921 gallons into INJ-3. Assuming uniform and radial distribution of the substrate away from the injection well screen, and an effective porosity of 15 percent, the calculated radius of influence of the substrate ranged from 4.8 to 5.1 feet (1.46 to 1.55 meters) for each injection location. Although the calculated radius of influence was about 5 feet (1.5 meters) from each injection well, substrate was observed in a monitoring well 13 feet (4.0 meters) from the nearest injection well, and evidence of groundwater mounding was observed in monitoring wells as far away as 50 feet (15.2 meters) away. This indicates that the substrate was preferentially distributed along horizons of higher permeability, and that the overall area of influence was greater than calculated.

The substrate mixture was initially injected at a pressure of approximately 10 pounds per square inch (psi) and at a rate of approximately 1.3 gallons per minute (gpm). However, some leakage of the mixture was observed through the injection well seals. Lowering of injection pressure to 3 to 5 psi reduced any leakage through the wells seals. At the lower injection pressure the injection rate decreased to approximately 0.8 gpm, with the pilot test injection taking a total of 5 days.

#### **4. PILOT TEST RESULTS**

The pilot test achieved a significant reduction in concentrations of 1,1,1-TCA, 1,1-DCA, and 1,1-DCE within and downgradient of the reaction zone (Table 1). Concentrations over time for 1,1,1-TCA and CA are presented in Figures 1 through 4. Red triangles depict the injection wells, while contour intervals are based on remedial action levels. Shaded areas represent action level exceedances, and areas of progressively darker shading indicate order of magnitude exceedances above the action level. Figure 1 and Figure 2 show 1,1,1-TCA concentrations just prior to injection and at 20 months post-injection, respectively. For the latter, the only concentrations of 1,1,1-TCA exceeding the clean-up goal are located up- and cross-gradient of the injection wells.

Figure 3 and Figure 4 show the distribution of CA just prior to injection and at 20 months post-injection, respectively. Concentrations of the dechlorination product CA in the injection/source area increased significantly post-injection at well locations MW-7, MW-16, INJ-1, and INJ-2 (Table 1), with concentrations of CA peaking at approximately 3 to 9 months post-injection. Concentrations of CA also increased at downgradient locations MW-4 and MW-5. While concentrations of CA remain elevated in the source area at 20 months post-injection, the concentrations are steadily decreasing from post-injection peaks (Table 1). This indicates that sequential dechlorination of 1,1,1-TCA and 1,1-DCA to CA was stimulated, but that the rate at which CA was degraded was lower than the rate at which it was produced.

Figure 5 shows the total molar and molar concentration of each CAH compound over time for groundwater samples collected from monitoring location MW-7, central to the injection area. The total molar concentration of contaminants in MW-7 spiked after injection. This was likely the result of contaminants sorbed to the soil matrix being mobilized by substrate injection, with vegetable oil and lactate potentially acting as surfactants.

Concentrations of 1,1,1-TCA at well MW-7 were significantly reduced within 3 months, followed by a reduction in 1,1-DCA within 6 months. By 9 months post-injection, CA represented nearly 100% of the total molar concentration of CAHs. With the depletion of parent compounds, CA concentrations began to decline in the treatment area and show a marked reduction between 15 and 20 months post-injection. This information was used for the full-scale application to allow sufficient treatment time (*i.e.*, a longer design life) for reduction of CA to reach target levels.

Table 1: Volatile Organic Compounds in Groundwater

Well Number	Date Sampled	Depth Sampled										
			1,1,1-Trichloroethane	1,1-Dichloroethane	Chloroethane	Tetrachloroethene	Trichloroethene	cis-1,2-Dichloroethene	1,1-Dichloroethene	Vinyl Chloride	Methylene Chloride	Chloromethane
Action Level			200	810	4.6	5	5	70	7	2	4.3	1.5
Source of Action Level			MCL	R-9	R-9	MCL	MCL	MCL	MCL	MCL	R-9	R-9
<b>MW-1</b>	12/5/2001	bailer		2.6								
	8/30/2003	12.7	0.22J	0.99J								
	3/16/2004	16										
	6/28/2004	16		0.52J								
	9/22/2004	16		0.85J								
	12/16/2004	16		0.43J								
	5/17/2005	16		0.28J								
11/2/2005	16		0.62J									
<b>MW-2</b>	12/5/2001	bailer	2.5	6.6								
	8/27/2003	12	1.6	4.8		0.27J			0.35J			
	3/18/2004	15		2.5								
	6/30/2004	15		3.4	1.2				0.49J			
	9/23/2004	15		6					0.5J			
	12/15/2004	15		2.9					0.25J			
	5/17/2005	15		1.3								
11/2/2005	15		5.1					0.4J				
<b>MW-2D</b>	8/27/2003	29				1.1	0.23J	0.65				
	3/18/2004	35										
	6/28/2004	32.5										
	9/20/2004	32.5										0.40JB
	12/14/2004	32.5										
	5/17/2005	32.5										
	11/2/2005	32.5										
<b>MW-3</b>	12/5/2001	bailer	<b>2700</b>	630					<b>340</b>			
	8/27/2003	12	<b>620</b>	240		<b>19J</b>			<b>98</b>			
	3/19/2004	16	<b>260</b>	92					<b>44</b>			
	6/29/2004	15.3	<b>810</b>	460					<b>76</b>			
	9/23/2004	15.5	<b>980</b>	760					<b>150</b>		<b>42JB</b>	
	12/14/2004	15.5	<b>420</b>	180					<b>67</b>			
	5/17/2005	15.5	<b>590</b>	230					<b>78</b>		<b>11J</b>	
11/2/2005	bailer	<b>1200</b>	980	20J				<b>180</b>		<b>40J</b>		
<b>MW-3D</b>	8/27/2003	27	0.22J	0.49J								
	3/19/2004	30										
	6/29/2004	30.5										
	9/20/2004	30.5										0.41JB
	12/14/2004	30.5										
	5/17/2005	30.5										
	11/2/2005	30.5										
<b>MW-4</b>	12/6/2001	bailer		64								
	8/29/2003	13	2.7J	280	<b>13</b>	2.2J			<b>18</b>			
	3/17/2004	16		140	<b>15</b>				<b>13</b>			
	7/1/2004	16		140	<b>37</b>				<b>14</b>		<b>15B</b>	
	9/23/2004	16		100	<b>39</b>				<b>12</b>		<b>2.9JB</b>	
	12/14/2004	16		67	<b>100</b>				6.3	<b>4.8J</b>		
	5/17/2005	16		25	<b>120</b>				2.5J	1.1J		
11/2/2005	bailer		9.8	<b>120</b>				3.5J	<b>2.0J</b>	1.5J		
<b>MW-4D</b>	8/28/2003	26.4		0.44J								
	3/20/2004	29										
	6/30/2004	29.5		0.49J								
	9/22/2004	29.5		1.1								
	12/15/2004	29.5		1.1								
	5/17/2005	29.5		0.33J								
	11/2/2005	29.5		1.1	0.88J				0.2J			
<b>MW-5</b>	12/6/2001	bailer		<b>3100</b>					<b>210</b>			
	8/28/2003	13	4.0J	540	<b>31</b>	<b>5.4J</b>			<b>51</b>		<b>6.0J</b>	
	3/20/2004	16	11	270	<b>52</b>				<b>28</b>			
	7/1/2004	16	13	300	<b>68</b>				<b>31</b>		<b>37B</b>	
	9/22/2004	16		160	<b>100</b>				<b>24</b>	1.9J	3.7JB	
	12/15/2004	16		120	<b>94</b>				<b>16</b>	<b>4.1J</b>		
	5/17/2005	16		44	<b>130</b>				<b>11</b>	1.5J		
11/2/2005	bailer		15	<b>97</b>				<b>8.1</b>	<b>2.0J</b>			

Table 1: Volatile Organic Compounds in Groundwater

Well Number	Date Sampled	Depth Sampled										
			1,1,1-Trichloroethane	1,1-Dichloroethane	Chloroethane	Tetrachloroethene	Trichloroethene	cis-1,2-Dichloroethene	1,1-Dichloroethene	Vinyl Chloride	Methylene Chloride	Chloromethane
Action Level			200	810	4.6	5	5	70	7	2	4.3	1.5
Source of Action Level			MCL	R-9	R-9	MCL	MCL	MCL	MCL	MCL	R-9	R-9
<b>MW-5D</b>	8/29/2003	36		2.8								
	3/20/2004	35		1.1								
	6/30/2004	34.6		0.55J								0.14JB
	9/22/2004	34.6		1.3								
	12/15/2004	34.6		1.5								
	5/17/2005	34.6		1.3								
	11/2/2005	34.6		0.81J								
<b>MW-6</b>	12/7/2001	bailer										
	8/30/2003	14.9		1.8								
	3/21/2004	18		7.7								
	6/28/2004	18		11	0.77J			0.53J				0.15J
	9/21/2004	18		15	1.5			0.72J				0.40JB
	12/16/2004	18										
	5/8/2005	18		2.9	0.28J							
11/2/2005	18											
<b>MW-7</b>	12/5/2001	bailer	<b>760</b>	<b>5900</b>	<b>390</b>				<b>830</b>			
	8/26/2003	12	<b>1,800</b>	<b>1,600</b>	<b>89</b>		<b>16J</b>		<b>310</b>			
	9/14/2003	7	<b>1,400</b>	<b>770</b>	<b>55</b>				<b>210</b>			
	9/14/2003	12	<b>2,000</b>	<b>1,400</b>	<b>73</b>		<b>18J</b>		<b>310</b>			
	9/14/2003	16	<b>2,200</b>	<b>1,500</b>	<b>67</b>				<b>320</b>			
	3/16/2004	16	<b>2,300</b>	<b>1,200</b>	<b>110</b>				<b>280</b>			
	7/2/2004	16	<b>33J</b>	<b>1,400</b>	<b>1900</b>				<b>71J</b>	<b>29J</b>	<b>300B</b>	
	7/2/2004	5.5	<b>680</b>	<b>600</b>					<b>150</b>		<b>110B</b>	
	9/24/2004	16		<b>41J</b>	<b>1700</b>						<b>61J,B</b>	
	12/14/2004	16			<b>1300</b>							
	5/18/2005	16			<b>1600</b>							
11/3/2005	bailer			<b>1000</b>						<b>18J,B</b>		
<b>MW-7D</b>	8/28/2003	26.9	1.4	5.1					0.77J			
	8/28/2003	31	1.1	3.9					0.58J			
	3/16/2004	29										
	7/1/2004	29	2.2	2.6					0.27J			
	9/23/2004	29							0.42J			
	12/14/2004	29		0.48J								
	5/17/2005	29										
11/2/2005	29											
<b>MW-8</b>	12/7/2001	bailer										
	8/29/2003	14.6		2.8								
	3/19/2004	18		2.3								
	6/29/2004	18		5.9	0.38J				0.26J			
	9/21/2004	18		5.3								0.34JB
	12/16/2004	18		0.91J								
	5/17/2005	18		2.3	0.89J							
11/2/2005	18		2.7	2.9				0.28J				
<b>MW-8D</b>	8/29/2003	33.9										
	3/20/2004	37										
	6/30/2004	36.7										
	9/22/2004	36.5										
	12/15/2004	36.9										
	5/17/2005	36.9										
	11/2/2005	36.8										
<b>MW-9</b>	12/7/2001	bailer										
	8/30/2003	14.5										
	3/21/2004	16										
	6/28/2004	18										
	9/21/2004	18										0.44JB
	12/16/2004	18										
	5/18/2005	18										
11/2/2005	18											
<b>MW-10</b>	8/29/2003	14.4		620	<b>200</b>				<b>65</b>			
	3/16/2004	17		120	<b>350</b>				<b>58</b>			
	6/28/2004	17		90	<b>400</b>				<b>70</b>			
	9/21/2004	17		37	<b>420</b>				<b>58</b>	<b>2.9J</b>		<b>4.1JB</b>
	12/15/2004	17		14	<b>340</b>				<b>43</b>	<b>12</b>		
	5/18/2005	17.5		6.9J	<b>310</b>				<b>24</b>	<b>3.5J</b>		
	11/2/2005	bailer		3.8J	<b>270</b>				<b>20</b>	<b>2.3J</b>		



Table 1: Volatile Organic Compounds in Groundwater

Well Number	Date Sampled	Depth Sampled	Volatile Organic Compounds									
			1,1,1-Trichloroethane	1,1-Dichloroethane	Chloroethane	Tetrachloroethene	Trichloroethene	cis-1,2-Dichloroethene	1,1-Dichloroethene	Vinyl Chloride	Methylene Chloride	Chloromethane
Action Level			200	810	4.6	5	5	70	7	2	4.3	1.5
Source of Action Level			MCL	R-9	R-9	MCL	MCL	MCL	MCL	MCL	R-9	R-9
MW-11	8/30/2003	15.84		91					2.7J			
	3/21/2004	18		210	130				14			
	6/28/2004	18		110	79				10			
	9/21/2004	18		200	310				29	2.3J		3.3JB
	12/16/2004	18		0.33J								
	5/17/2005	18		57	220				21	5.7J		
	11/2/2005	18		6.4	37				4.0	0.87J		37
MW-12	3/17/2004	15										
	6/28/2004	15.5										
	9/21/2004	15										0.32JB
	12/16/2004	15										
	5/18/2005	15										
	11/2/2005	15										
MW-13	3/23/2004	15	5.5	10					9.2			
	6/28/2004	15	9.1	13					11			
	9/21/2004	15	6.4	12					9.2			0.34JB
	12/16/2004	15	3.1	7.2					0.33J			
	5/17/2005	15	3.9	7.7					3.3			
	11/2/2005	15	2.5	8.2					1.3			
MW-14	3/23/2004	17										
	6/29/2004	17		0.21J					0.24J			
	9/22/2004	17		0.58J								
	12/14/2004	17		0.92J								
	5/17/2005	17		0.26J								
MW-15	3/23/2004	18										
	6/29/2004	18	0.36J	2					0.29J			
	9/22/2004	18	0.34J	1.1					0.26J			
	12/14/2004	18	0.69J	0.72J								
	5/18/2005	18	1.0	0.44J								
MW-16	3/23/2004	16	1600	2800	110				340			
	7/2/2004	16	49J	2100	77				150		220B	
	9/23/2004	16		540	690				13J	17J	22J	
	12/15/2004	16	74	760	1200				42J	30J		
	5/18/2005	16		270	1000							
	11/3/2005	bailer	45	220	360				14	8.0J		
MW-17	12/16/2004	16										
	5/18/2005	16										
	11/2/2005	16										
MW-18	12/16/2004	16	0.74J	1.2								
	4/3/2006	16		0.34J								
	10/6/2006	16		0.28J								
MW-19	12/15/2004	16	2.3	4					1.1			
	5/17/2005	16	2	1.9					0.39J			
	11/2/2005	16	2.2	2.3					0.56J			
INJ-1	3/23/2004	16	4100	1100					400			
	7/1/2004	16	86J	7300	240J				410		1000B	
	9/24/2004	16		89J	5200						180JB	
	12/13/2004	16		72J	3500							
	5/18/2005	16			3200							
	11/3/2005	bailer			1600						26J,B	
INJ-2	3/23/2004	16	1000	1300	58				340			
	7/2/2004	16	53	390					41		39B	
	9/24/2004	16		500	29				33		15JB	
	12/13/2004	16		140	240							
	5/18/2005	16			520							
	11/3/2005	bailer		17	420				6.2J			

All Concentrations in micrograms per liter (ug/L)

MCL indicates the US EPA Maximum Contaminant Limit for drinking water (Primary Drinking Water Standard).

R-9 indicates the 2002 Region 9 Preliminary Remediation Goal for tap water.

Blank cells indicate a non-detect analytical result.

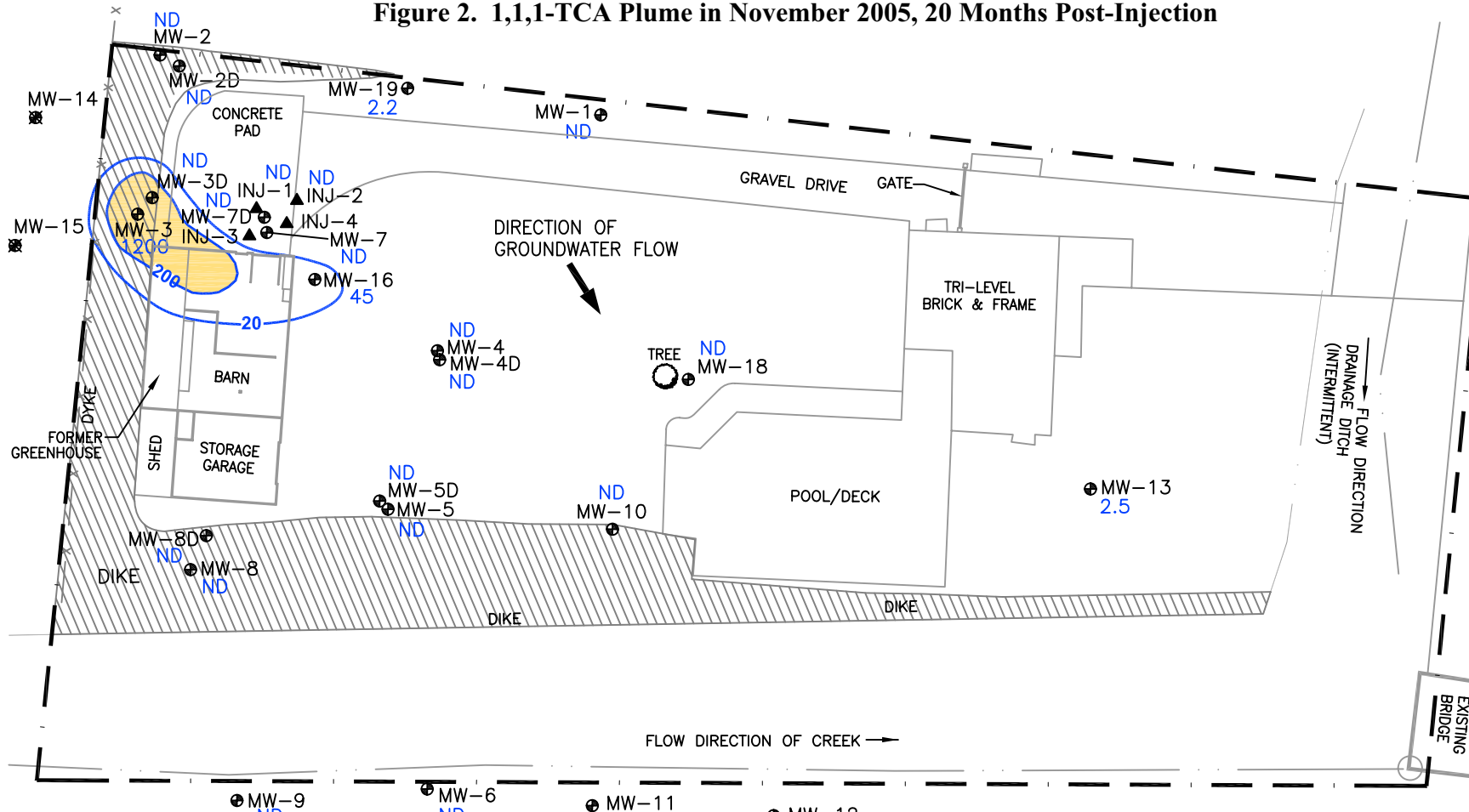
Bold numbers indicate a concentration in excess of the MCL or if an MCL does not exist for the compound, the Region 9 PRG for tap water.

"J" flag indicates the analyte was detected above the method detection limit, but below the reporting limit; the concentration is estimated.

"B" flag indicates the analyte was also detected in the method blank.

\*Samples collected in September 2003 and select samples in December 2004 were collected using diffusion bag samplers. All other samples with a depth indicated were collected using low flow sampling techniques.

Figure 2. 1,1,1-TCA Plume in November 2005, 20 Months Post-Injection

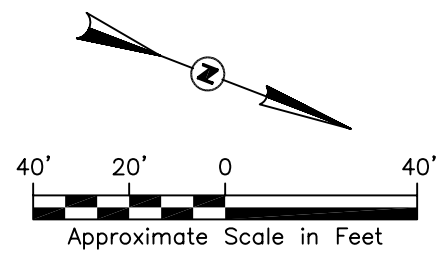


**LEGEND**

- ⊕ MONITORING WELL
- ⊗ ABANDONED MONITORING WELL
- ▲ INJECTION WELL
- - - - - PROPERTY BOUNDARY
- x - FENCE
- 2.5 1,1,1-TRICHLOROETHANE CONCENTRATION (ug/L)
- 200— 1,1,1-TRICHLOROETHANE ISOCONCENTRATION LINES (ug/L)
- ND NOT DETECTED

CONCENTRATIONS IN GROUNDWATER EXCEEDING MCL

200 - 1,200



**Figure 3. Chloroethane Plume in March 2004, Prior to Injection**

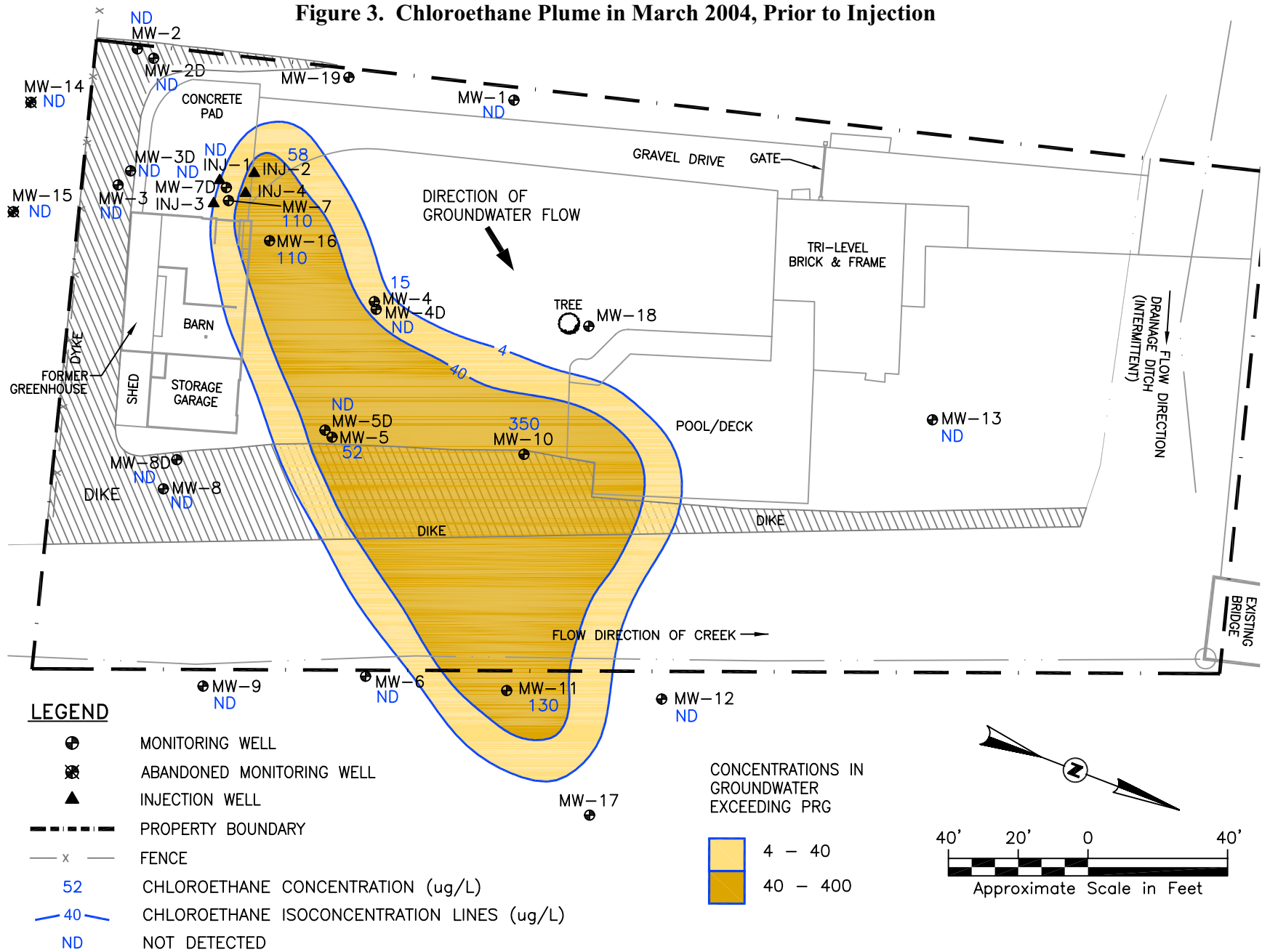
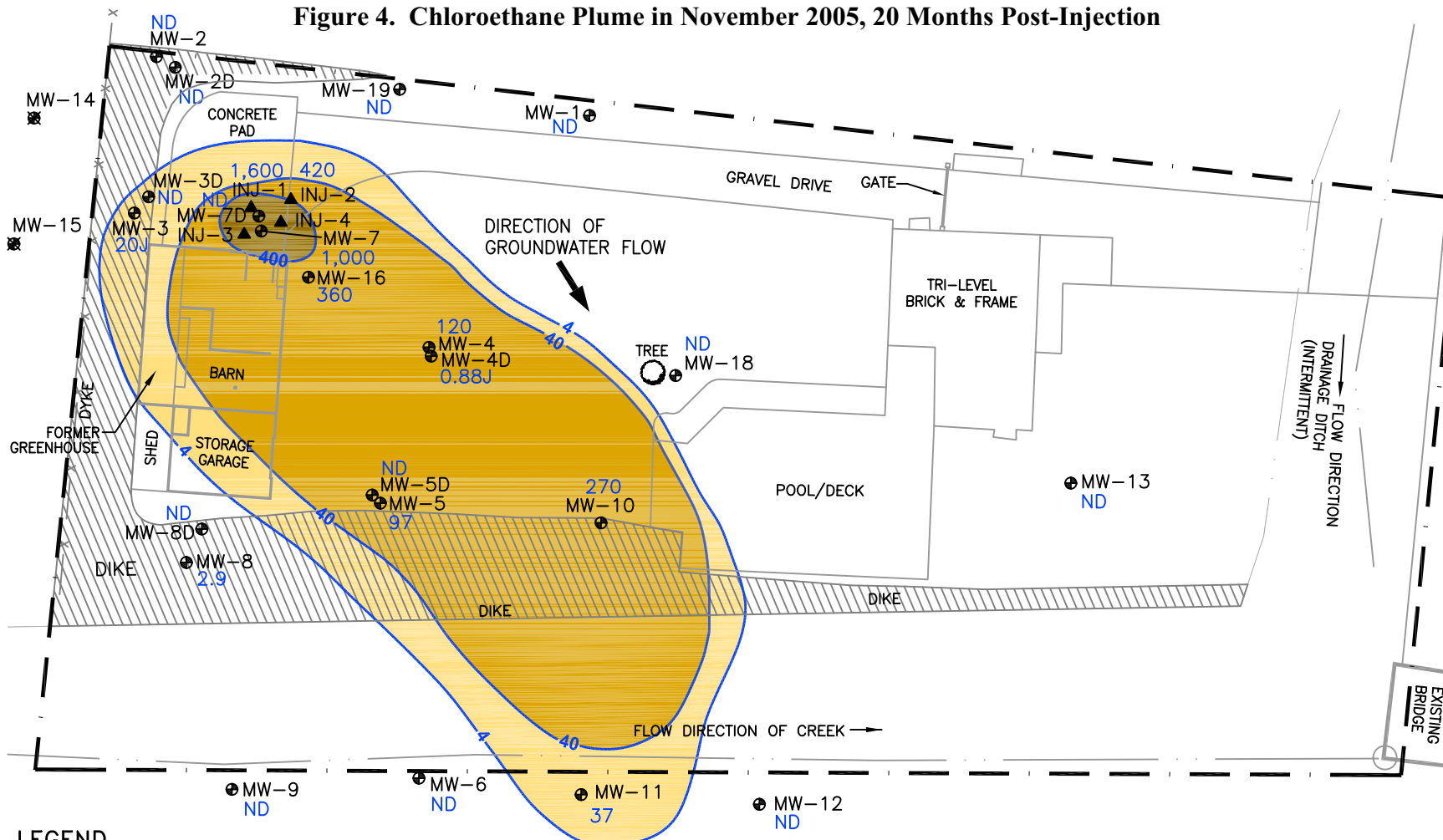


Figure 4. Chloroethane Plume in November 2005, 20 Months Post-Injection

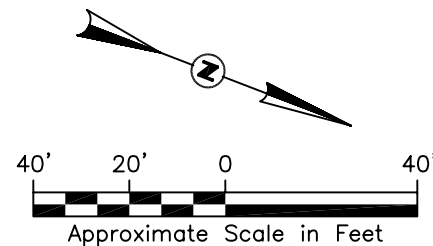


**LEGEND**

- ⊕ MONITORING WELL
- ⊗ ABANDONED MONITORING WELL
- ▲ INJECTION WELL
- - - - - PROPERTY BOUNDARY
- x - FENCE
- 37 CHLOROETHANE CONCENTRATION (ug/L)
- 40 CHLOROETHANE ISOCONCENTRATION LINES (ug/L)
- ND NOT DETECTED

CONCENTRATIONS IN GROUNDWATER EXCEEDING PRG

4 - 40
40 - 400
400 - 1,600



**FIGURE 5 - CONCENTRATIONS OF SELECT CAHs  
AT TREATMENT ZONE LOCATION MW-7**

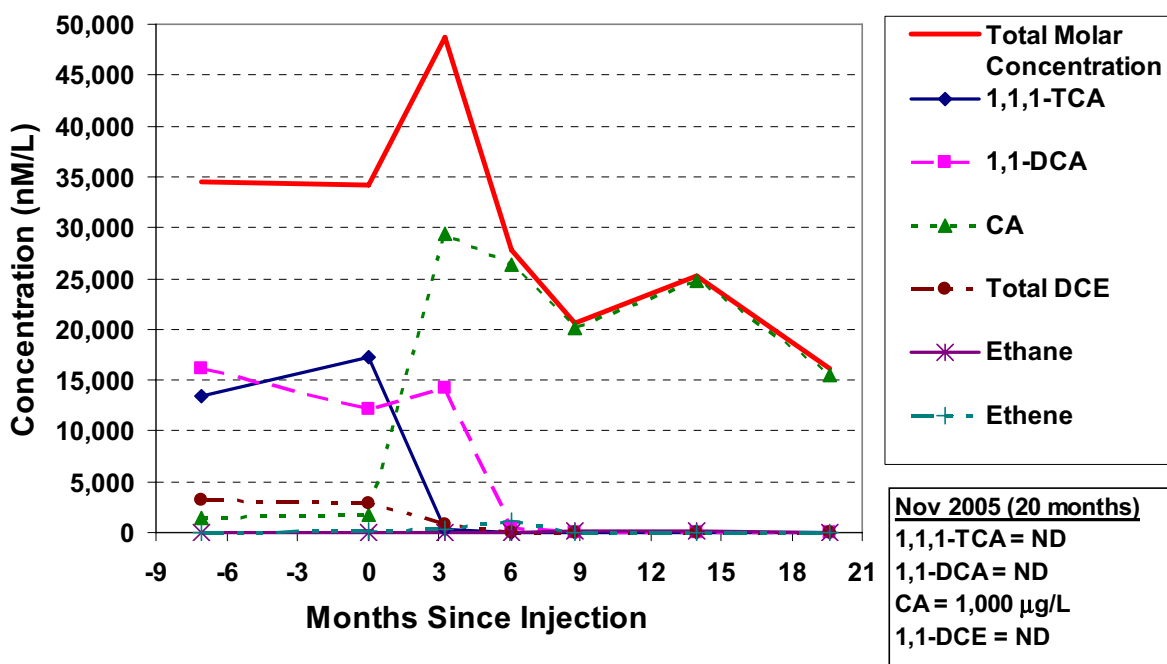
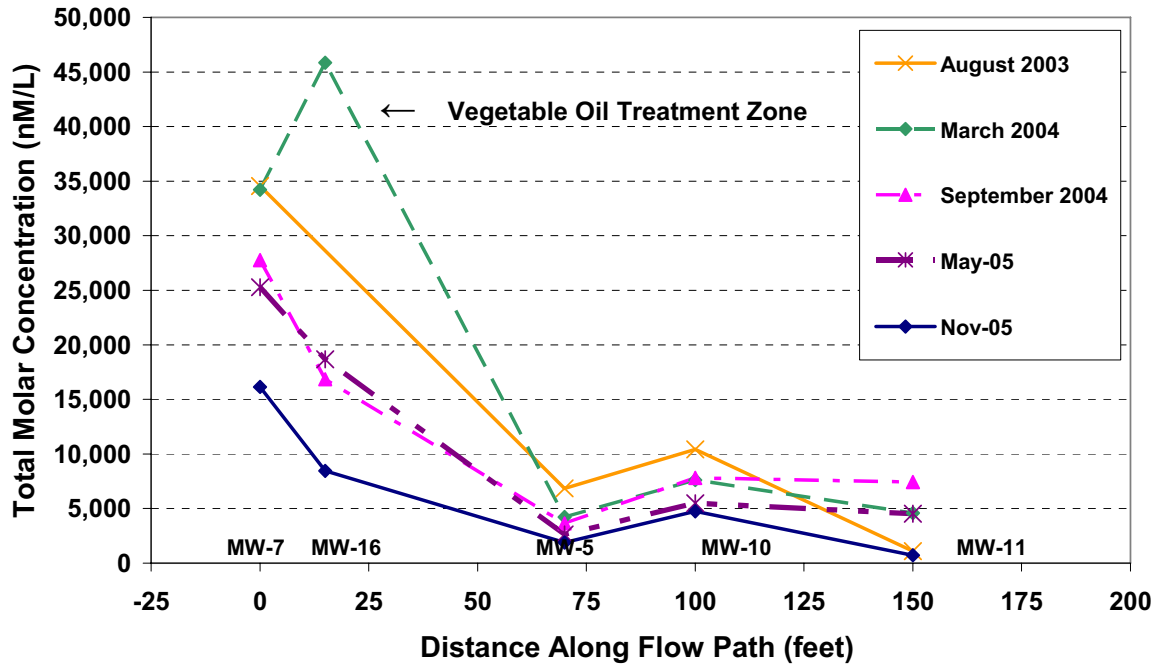


Figure 6 is a plot of the total molar concentration for wells located along the axis of the plume. Each plotted line represents a subsequent sampling event, and it is evident that after the first post-injection sampling event the total molar concentrations along the entire plume axis have been reduced.

Background concentrations of total organic carbon (TOC) in site groundwater prior to injection were less than 3.0 milligrams per liter (mg/L). After injection in July 2004, TOC was elevated to 270 mg/L within the injection zone and to 17 mg/L in a monitoring well located 13 ft (4.0 m) downgradient (Figure 7). Concentrations of TOC greater than 20 mg/L were sustained within the immediate injection zone for at least 20 months post-injection (November 2005). In September 2004, the concentration of TOC peaked at the downgradient monitoring well at a concentration of 69 mg/L. This suggests that the reactive zone expanded over time as a result of migration of the soluble component (*i.e.*, lactate) of the substrate mixture. Elevated levels of TOC have not been observed at more distant monitoring locations.

Concentrations of volatile fatty acids (VFAs), acetic acid in particular, were elevated in a distribution similar to TOC (data not shown). VFAs are metabolic degradation products of vegetable oil and lactate. The dominant VFA measured at the site is acetic acid, indicating the indigenous microbial population is prone to acetic acid generation.

**FIGURE 6**  
**TOTAL MOLAR CONCENTRATIONS OF CAHs WITH DISTANCE**



**FIGURE 7**  
**CONCENTRATIONS OF TOTAL ORGANIC CARBON ALONG THE FLOWPATH THROUGH THE TREATMENT ZONE**

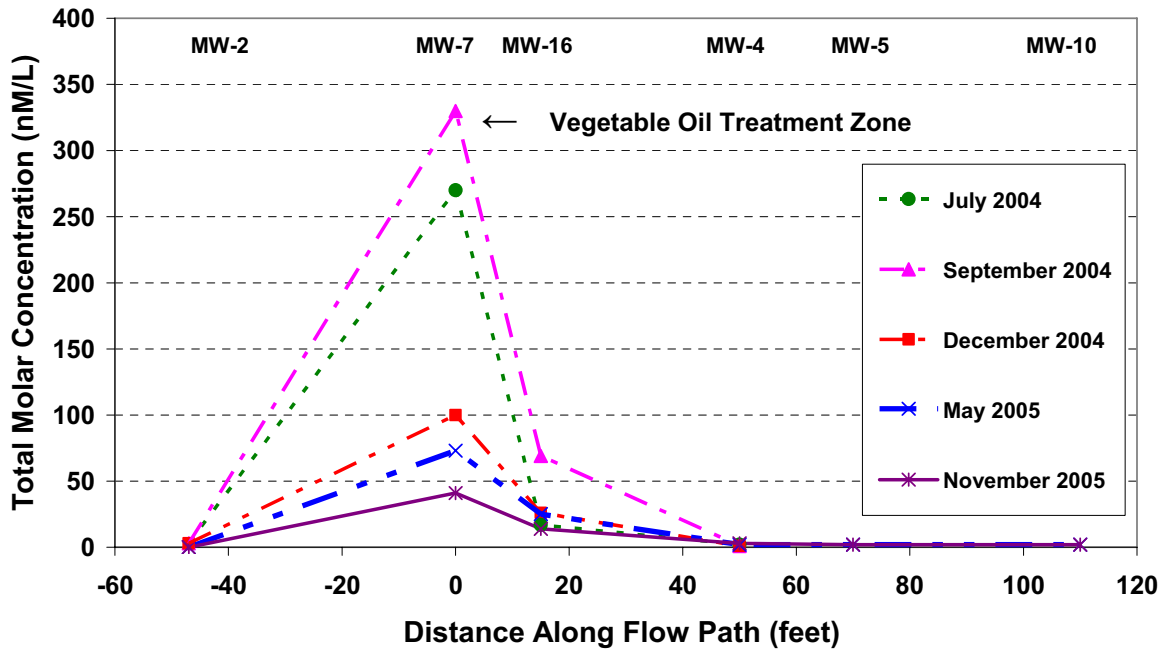
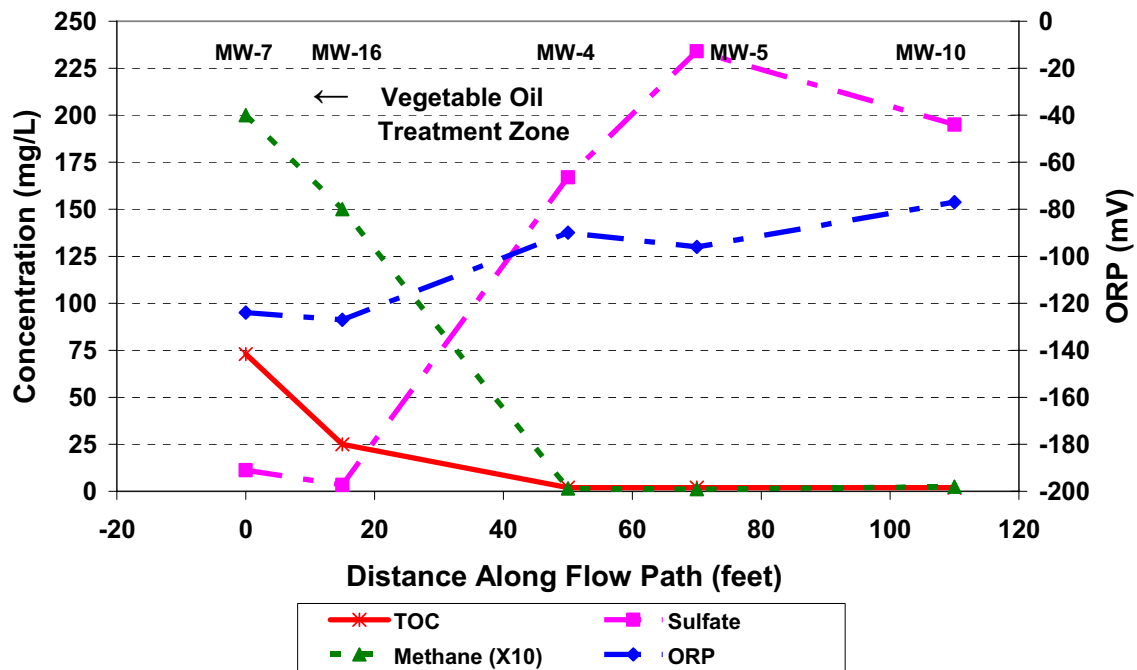


Figure 8 plots changes in the groundwater geochemical indicator parameters TOC, sulfate, methane (plotted at 10 times its concentration), and oxidation-reduction potential (ORP) with distance from the injection zone (well MW-7) at 15 months post-injection. Geochemical conditions within the reaction zone were close to optimal for anaerobic dechlorination to occur. Sulfate has been depleted, methane has been produced, and ORP is lowered. Sulfate is the most significant competing electron acceptor at this site. Background concentrations of sulfate vary between 46 mg/L and 200 mg/L, but have been reduced to below 12 mg/L within the reaction zone. Outside of the reaction zone the concentration of sulfate rapidly rebounds to background. Concentrations of methane within the reaction zone in May 2005 were 20 mg/L at well MW-7 and 15 mg/L at well MW-16, but rapidly decreased to less than 1 to 3 mg/L downgradient of the reaction zone. While methanogenesis may consume a large proportion of organic substrate, it does not appear to inhibit anaerobic dechlorination processes at this site.

**FIGURE 8**  
**CHANGES IN GEOCHEMISTRY WITH DISTANCE**  
**(MAY 2005)**



## 5. SUMMARY

Together, sulfate reduction and methanogenesis were estimated to exert over 94 percent of the native electron acceptor demand at the site. Chlorinated solvents in groundwater and sorbed to the soil matrix were estimated to account for less than 2 percent of the total substrate demand. Sufficient substrate mass was applied to meet the estimated electron acceptor demand for a design life of 18 to 24 months. At 20 months post-injection, 1,1,1-TCA, 1,1-DCA, and 1,1-DCE were no longer detected in the treatment zone. Concentrations of CA peaked at 6 to 9 months post-injection before beginning to decline, but remained above the groundwater action level at 20 months.

Therefore, the reaction zone may need to be sustained beyond the initial pilot test design life to achieve target concentrations for CA. Concentrations of TOC, an indicator of substrate

availability, have steadily declined since injection but remain above 20 mg/L, the level of TOC considered to be the minimum threshold concentration necessary to support anaerobic dechlorination at this site. The decline in TOC, coupled with increasing sulfate concentrations, indicated additional injection of substrate was necessary to achieve final cleanup goals within the pilot test area.

## **6. IMPLICATIONS FOR FULL SCALE APPLICATION**

The pilot test successfully stimulated anaerobic dechlorination resulting in the total reduction of 1,1,1-TCA in groundwater to cleanup levels across the entire site. A subsequent decline in the concentrations of CA, coupled with a decline in concentrations of TOC and a rebound in concentrations of sulfate, triggered a full-scale application. The full-scale application was designed based on results of the pilot test, and was implemented from November 2005 to January 2006 (approximately 21 months after the initial pilot test injection) to treat the entire contaminant plume (Figure 9).

Data from the pilot test were used to calculate site-specific substrate demand and to optimize the full-scale injection design. Changes in the technical approach from the pilot test included the use of direct-push technology for injection (Figure 10), an increase in the design life cycle to 3 years by increasing the effective residual oil saturation, and the withdrawal of the make-up water from within the injection zone to reduce the effects of groundwater displacement.

## **7. PRELIMINARY RESULTS FOR FULL SCALE APPLICATION**

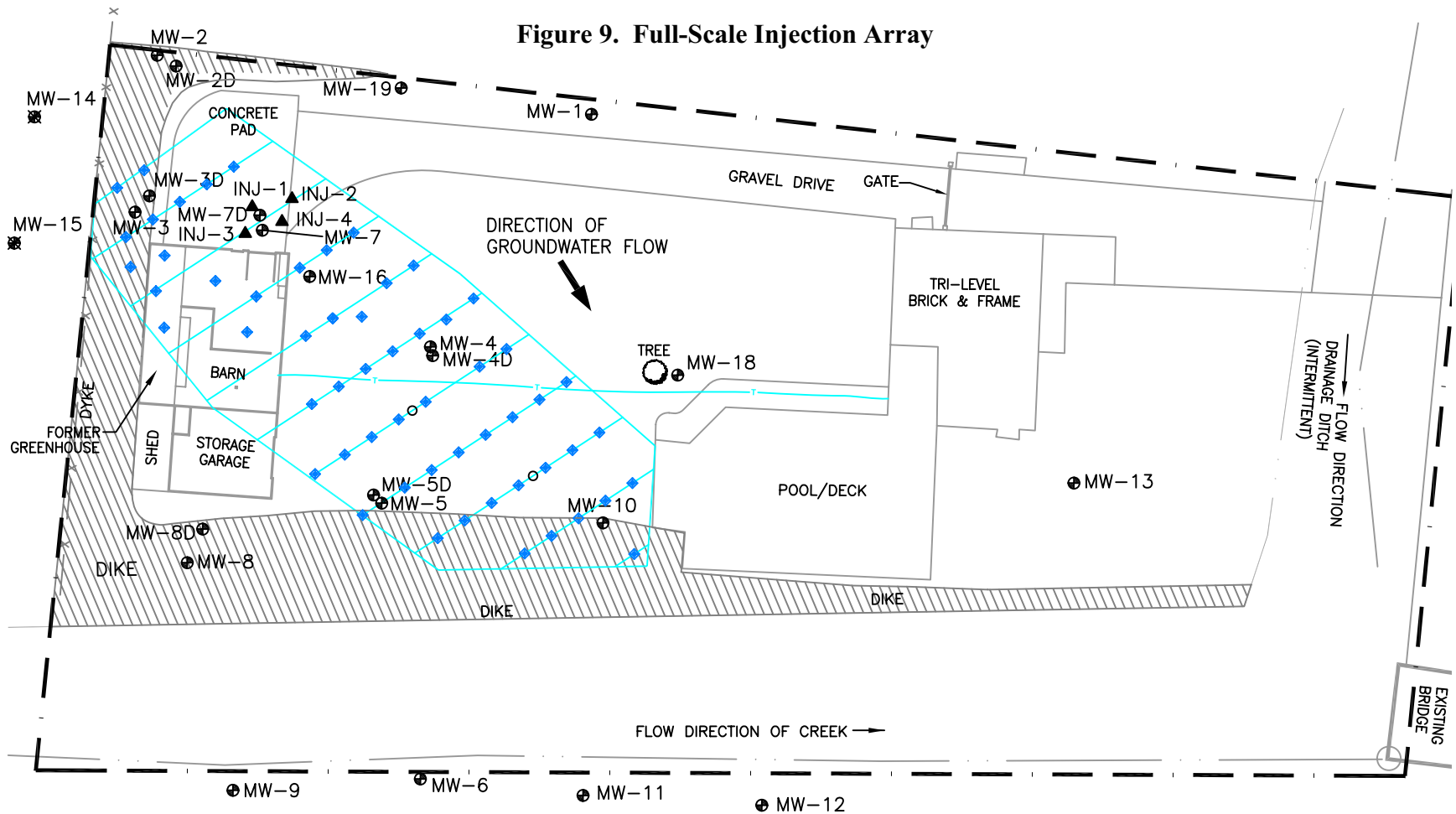
Initial results of the full-scale application indicate that concentrations of CA continue to decline at most locations. Concentrations of select CAHs at injection area well MW-07 and downgradient well location MW-10 are shown on Figure 11 and Figure 12, respectively. Concentrations of CA continue a decreasing trend as observed prior to the full-scale injection. At other locations, a moderate increase in CA was observed at 3 months after the full-scale injection, with a subsequent decrease in concentrations CA in a trend similar to that observed during the pilot test. The full-scale application continues to be monitored as the final remedy for the site.

## **8. REFERENCES**

Ferris, S., B. Henry, C. Coker, and R. Lantzy. 2006. Pilot Test Evaluation for Enhanced Anaerobic Bioremediation of Chlorinated Ethanes. *Proceedings of the Fifth International Conference on Remediation of Chlorinated and Recalcitrant Compounds*. Monterrey, California, May 2006. Paper B-25. Battelle Press, Columbus, Ohio.



**Figure 9. Full-Scale Injection Array**



**LEGEND**

- ⊕ MONITORING WELL
- ⊗ ABANDONED MONITORING WELL
- ▲ INJECTION WELL
- ◆ INJECTION POINT
- TEMPORARY WELL
- - - - - PROPERTY BOUNDARY
- x — FENCE

MW-17  
⊕

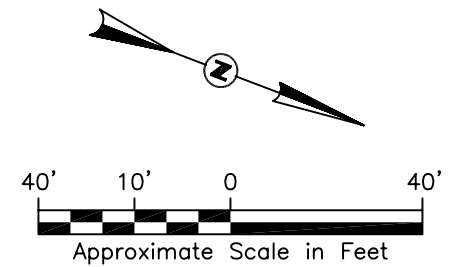
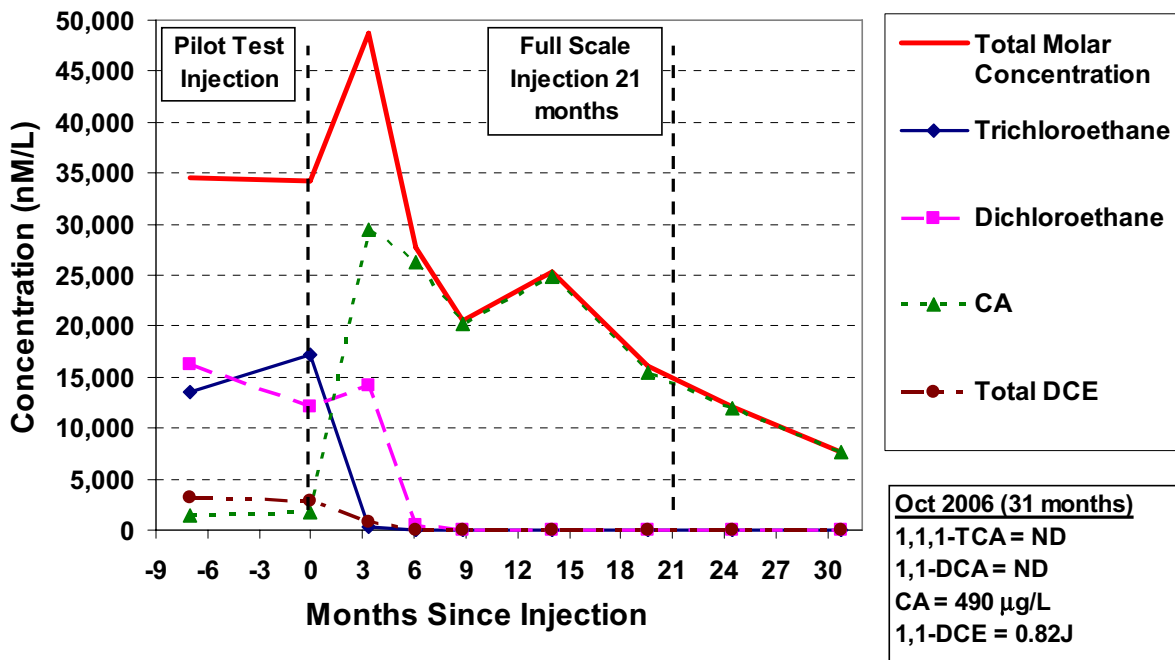




Figure 10. Direct Injection Using a Geoprobe® for Full-Scale Injection

FIGURE 11 - CONCENTRATIONS OF SELECT CAHs  
AT TREATMENT ZONE LOCATION MW-7



**FIGURE 12 - CONCENTRATIONS OF SELECT CAHs  
AT LOCATION MW-10**

